



OPERATOR'S MANUAL

Tunnel Boring Machine Series II

48SC - 420 - 480 - 540 - 600 - 660 - 720 - 780

S/N: F24600F - F31000F - F28500F - F28600F - F25900F - F28700F - F28800F - F31100F

Publication No. 050076A

Rev. No. 141218

© Akkerman Inc. 2014
All Rights Reserved

Akkerman Inc. 58256 266th Street Brownsdale, MN 55918
Phone: 507-567-2261 Fax: 507-567-2605 email: akk@akkerman.com

SERVICE • RELIABILITY • INNOVATION

Introduction

This operator's manual contains important safety, operation, and maintenance information for your Akkerman Tunnel Boring Machine (TBM). You must read and understand this manual, your haul unit operator's manual, pump unit operator's manual, and your gas detection system operation manual before you operate and maintain this equipment. Keep this manual with your TBM at all times. Directions in this manual are referenced from the launch shaft going forward to the reception shaft, unless otherwise noted. Additional copies of this manual may be purchased from the Akkerman Aftermarket Support Department, or downloaded from the Akkerman web site at www.akkerman.com.

The contractor is responsible for the overall safety program on the job site. Use this manual as a part of the safety program.

The use of second rate parts could affect the efficient performance of the Tunnel Boring Machine. ALWAYS use genuine Akkerman parts.

Understand safety signal words, DANGER, WARNING, CAUTION, SAFETY INSTRUCTIONS, and NOTICE. When you see these words in this manual or on safety decals mounted on your equipment, follow the safety message to avoid personal injury and/or property damage.

▲ DANGER Indicates an extremely hazardous situation which, if not avoided, WILL result in death or serious injury.

▲ WARNING Indicates a potentially hazardous situation which, if not avoided, COULD result in death or serious injury.

▲ CAUTION Indicates a potentially hazardous situation, which, if not avoided, MAY result in minor or moderate injury. It may also be used to alert against unsafe practices.

SAFETY INSTRUCTIONS Usually consists of individual messages stating procedures or actions that must be followed for the safe operation of a product.

NOTICE Identifies potential property damage and important installation, operator, or maintenance information.



Akkerman 720 Series II Tunnel Boring Machine

Pipejacking and tunneling is a type of "trenchless technology" that utilize a tunnel boring machine (TBM). The TBM is advanced through the ground by hydraulic jacking cylinders on a jacking frame or pump unit from the launch shaft. As the TBM is advanced, powerful hydraulic motors rotate a bearing/inner drum. A cutterhead or closed face attachment is connected to the drum. As it rotates, the attachment teeth excavate the face and the spoils fall into the drum. Scoops and paddles in the drum dump the spoils onto a conveyor which carries the material to the dirt bucket. Once the dirt bucket is full, the dirt bucket is removed from the pipeline via a haul unit to the unloading area in the launch shaft where the dirt bucket is hoisted out of the shaft and unloaded.

If you find any errors with this manual or know of ways to improve procedures, please let us know. Email your comments via the form on the Contact Us page of the Akkerman web site, or mail your suggestions to: Akkerman Inc, ATTN: Technical Publications, 58256 266th Street, Brownsdale, MN 55918.

Akkerman Inc. reserves the right to improve its products without notice or obligation.

Periodic Maintenance.....	9-1	Storage	10-1
Lubrication and Maintenance Intervals	9-1	Preparing For Storage	10-1
Before Performing Maintenance	9-1	Removing From Storage	10-1
Lockout Power Before Servicing	9-2		
Hydraulic Oil/Fluids Under Pressure	9-3	Troubleshooting	11-1
Avoid Pinch Points	9-3	TBM Series II	11-1
Welding	9-3	Conveyor	11-4
Maintenance Charts	9-4	TBM Hydraulic Schematic	11-5
TBM	9-4	TBM Series II Electrical Schematic	11-6
Prior To Each Drive Launch	9-4	Pit Power Box Electrical Schematic	11-7
Detailed Procedures	9-9	Grease System Schematic	11-8
Daily or Every 10 Hours	9-5	Lube System Schematic	11-9
Detailed Procedures	9-20		
Weekly or Every 50 Hours	9-6	Specifications	12-1
Detailed Procedures	9-28	Tunnel Boring Machine	12-1, 12-2
After First Drive or First 100 Hours, Then		Conveyors	12-3
Monthly or Every 250 Hours Thereafter..	9-7	Yokes	12-4
Detailed Procedures	9-30	Skids	12-5
After Each Drive	9-8		
Detailed Procedures	9-33	Identification Numbers	13-1
Belt Conveyor.....	9-37	Safety Data Sheets	14-1
Prior To Each Drive Launch	9-37	Warranty	15-1
Detailed Procedures	9-40	Index	16-1
Daily or Every 10 Hours	9-38		
Detailed Procedures	9-46		
Weekly or Every 50 Hours	9-39		
Detailed Procedures	9-51		
Screw Conveyor.....	9-54		
Prior To Each Drive Launch	9-54		
Detailed Procedures	9-57		
Daily or Every 10 Hours	9-55		
Detailed Procedures	9-61		
Weekly or Every 50 Hours	9-56		
Detailed Procedures	9-64		

NOTES

Safety

BE ALERT FOR SAFETY INFORMATION

When you see this safety alert symbol on your equipment or in this manual, be alert to the possibility of personal injury or property damage.

Read all safety information.

Keep safety decals clean and in good condition. Replace missing or damaged safety decals.



**ATTENTION!
BECOME ALERT!
YOUR SAFETY IS INVOLVED!**

READ OPERATOR'S MANUAL

⚠️ WARNING Unsafe operation or maintenance can cause severe injury or death.

Read and understand the Operator's Manual before operating or servicing this equipment.

Any unauthorized modifications will void the warranty.

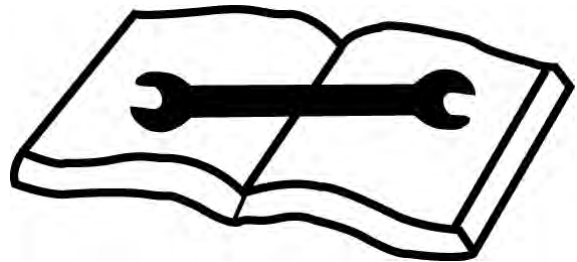

WEAR PROTECTIVE CLOTHING

Wear OSHA approved protective clothing, such as hard hat, gloves, safety goggles, earmuffs or ear plugs, face shield, and steel-toed boots, when operating and servicing this equipment.

Wear reasonably close fitting clothing and remove jewelry before working on or near this equipment. This will help prevent the danger of catching them in moving parts or controls.



LOCKOUT POWER BEFORE SERVICING

⚠ WARNING Failure to lockout power before servicing can cause severe personal injury or death.

LOCKOUT main power supply before servicing. Electrical repairs must be performed only by a certified electrician.



HYDRAULIC OIL/FLUIDS UNDER PRESSURE

⚠ WARNING Escaping oil or other fluids under pressure can penetrate your skin causing serious injury or death.

Release all pressure before performing maintenance or repairs. Never weld near pressurized fluid lines.

DO NOT use your hands to check for leaks. When searching for leaks, use a piece of wood or cardboard.

Contact medical help immediately if any oil or fluid is injected into your skin. A serious infection or reaction can emerge without proper medical treatment.



BEWARE OF SUSPENDED LOADS

⚠ WARNING Suspended loads may fall and cause severe personal injury or death.

If a hydraulic hose from the boom of a crane or excavator breaks, the boom can fall instantly.

Do not enter area under or around a load.



KEEP PERSONNEL AWAY FROM MOVING PARTS

⚠ WARNING Crushing hazard.
Keep personnel away from inside of jacking frame.
Failure to do so could result in serious personal injury or death.



UNAUTHORIZED WELDING

⚠ WARNING Unauthorized welding can cause structural failure resulting in possible injury or death.

Do not weld on any structural member.
Unauthorized welding or repair will void the warranty.

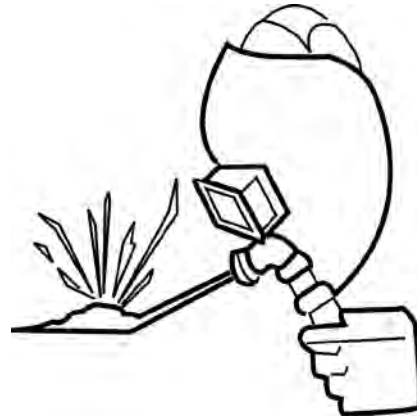

REGULARLY CLEAN AND INSPECT EQUIPMENT

Remove any grease, oil, or debris buildup to avoid potential injury or equipment damage.

Inspect equipment for damage. If damaged, repair or replace immediately.

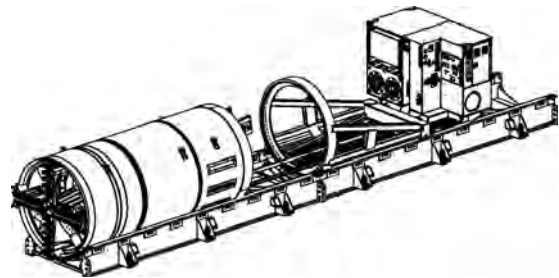

INSPECT ELECTRICAL CONNECTIONS

⚠ WARNING Regularly inspect electrical connections to be sure they are secure. Failure to do so could cause an explosion if moisture enters an unsecured electrical connection.



USING TUNNEL POWER CABLE

⚠ DANGER NEVER disconnect tunnel power cables when tunnel power is ON. Doing so WILL cause severe injury or death from electrical shock.



PRACTICE SAFE MAINTENANCE

⚠ WARNING Unexpected equipment movement may cause serious personal injury.

LOCKOUT power before performing any maintenance.

Shut down equipment before making repairs, adjustments, or removing obstructions.

Only trained and qualified personnel should perform any maintenance or repairs.

Keep the area around the equipment clean and dry when performing maintenance.

Do not service the machine while it is in motion.

Replace worn or damaged parts. Remove grease, oil, or debris buildup.

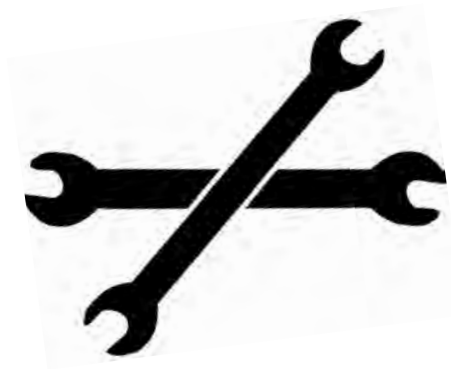

AVOID PINCH POINTS

⚠ WARNING Moving parts or the mishandling of parts can cause severe personal injury.

Keep hands away from moving parts.

Watch your fingers, hands, and legs while equipment is in operation.

Handle parts carefully to avoid crushing and pinch point hazards.



TEST TUNNEL VENTILATION

⚠ WARNING Keep TBM, tunnel and shafts well ventilated at all times.

Use an approved air analyzer to detect hazardous gases and oxygen content.

Before and during the shaft operation, test for combustible and toxic gases and oxygen deficiency.

If the levels exceed OSHA prescribed levels, leave tunnel and shaft immediately! Do not activate or deactivate any electrical or hydraulic devices, since any sparks could cause an explosion.

Once ALL personnel are out of tunnel/shaft, cut power from power source.

Gases must be removed before reentering tunnel/shaft.

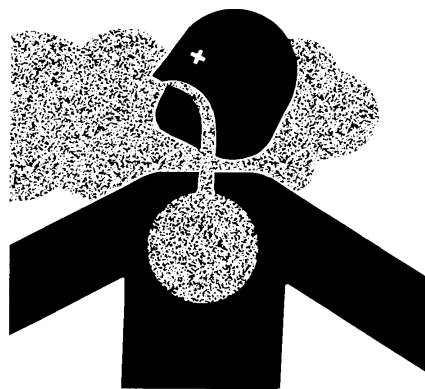

SLIPPERY WHEN WET

⚠ WARNING Slips and falls can cause serious personal injury.

Ensure firm footing in wet or slippery conditions.

Replace skid-resistant material if it is damaged or missing to prevent slips and falls.

Remove any buildup of grease, oil, or debris.



FIRE PREVENTION

⚠ CAUTION Fires can cause injury or property damage.

Keep equipment clean. Remove all debris from equipment.

Have a fire extinguisher available at all times. Keep the fire extinguisher fully charged.



CONVEYOR OPERATION

⚠ WARNING Conveyor can jam in rotating cutterhead causing conveyor to swing into operator, resulting in severe personal injury.

While cutterhead is rotating:

1. Operator **MUST** remain seated in normal operating position.
2. Cutterhead drive dump valve (conveyor safety valve) **MUST** be tethered to conveyor.
3. ALL FOUR safety chains **MUST** be secured to conveyor.

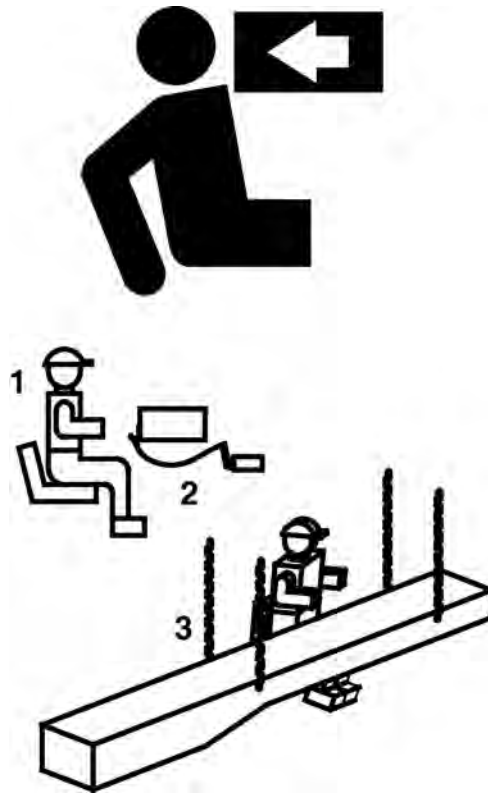

KEEP AWAY FROM BELT CONVEYOR (IF EQUIPPED)

⚠ DANGER Contact with rotating conveyor belt or idler rollers will cause severe injury or death.

Keep hands, body, and objects clear of rotating conveyor.

Do not operate without covers and guards in place.

Lockout power before servicing belt conveyor.



KEEP AWAY FROM AUGER (IF EQUIPPED)

⚠ DANGER Contact with rotating auger will cause severe injury or death.

Keep hands, body, and objects clear of operating auger.

Do not operate without covers and guards in place.

Lockout power before servicing.



STAY AWAY FROM CRANE

⚠ DANGER Stay away from operating crane. If close to power lines, the crane, load, and ground may become electrified resulting in serious injury or death.



KEEP RIDERS OFF HAUL UNIT

Allow only operator on operating seat when moving haul unit. Keep riders off.

Riders on haul unit can be easily injured by being struck by objects or being thrown off of the equipment. Riders can also obstruct the operator's view resulting in the equipment being operated in an unsafe manner.

A rider may be allowed in an empty dirt bucket (with contractor approval only), to transport personnel from the tunnel opening to the boring head. If allowed, the rider **MUST** be fully inside dirt bucket, including head and all other body parts, to avoid contact with obstructions. Also, rider cannot obstruct the operator's view.



524 Haul Unit With Dirt Bucket

AVOID TUNNEL WALL CONTACT

⚠ WARNING Contacting tunnel wall and other pipeline obstructions can cause severe personal injury or death.

Keep all body parts on haul unit while unit is moving.



WATCH FOR CONVEYOR

⚠ WARNING Avoid contact with conveyor. Failure to do so could cause severe injury or death.

While moving haul unit into tunnel, avoid hitting the conveyor.



NO SMOKING IN SHAFT OR TUNNEL

⚠ WARNING Smoking in shaft or tunnel could cause an explosion if combustible gases are present.

Do not smoke in shaft or tunnel.



KEEP JOB SITE CLEAN AND ORGANIZED

⚠ WARNING Tripping can cause serious personal injury.

Be sure to keep job site clean and organized.



LOCKOUT POWER BEFORE SERVICING HAUL UNIT

⚠ WARNING Failure to lockout power before servicing can cause severe personal injury or death.

Disconnect battery harness from contactor harness and remove battery pack from haul unit to LOCKOUT power before performing any maintenance.



CONTACT WITH POWER CABLE

⚠ DANGER Contact with a severed electrical cable WILL cause serious injury or death.

CONSTANTLY monitor electrical cables during drive to prevent cutting or stretching of any electrical cables.



AVOID LASER LIGHT EXPOSURE

⚠ DANGER Staring into laser light will cause severe injury.

Do not stare into laser guidance system light beam. Avoid direct eye exposure.

To avoid possible exposure to radiation in excess of acceptable emission limits, all repairs to laser must be performed by the original manufacturer or an authorized service technician.

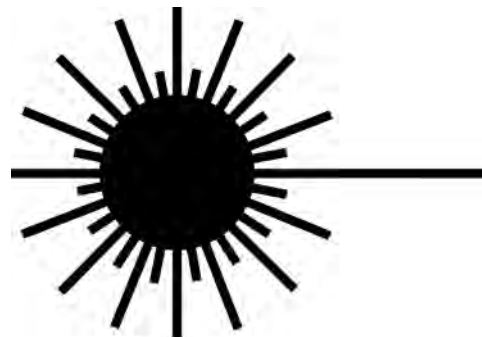

RECYCLE WASTE

Follow local, state, federal, and international regulations when recycling or disposing of waste. Waste includes fluids/oil, fuel, filters, coolant, and batteries.

Use leakproof containers when draining fluids/oil. Do not pour waste on the ground, down a drain, or into any water source.

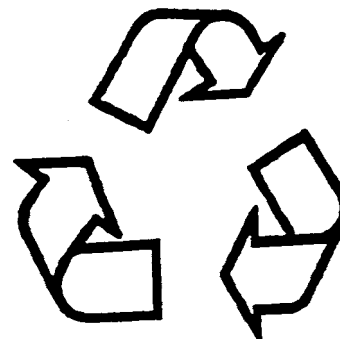

NOTES

Safety Decals

Keep all safety decals clean and readable. Use soft cloth, water, and a mild soap to clean the decals if they are too dirty to read. DO NOT clean safety decals with solvent. Solvent will damage the surface of the decal. Replace safety decals immediately if they are damaged, missing, or hard to read.

Serious injury or property damage can occur if safety instructions are not followed. Contact your Akkerman Aftermarket Support representative for free replacement safety decals.

If a part is replaced that has a safety decal on it, apply a new safety decal to the replacement part. Before applying a new decal, be sure the surface is clean and dry.

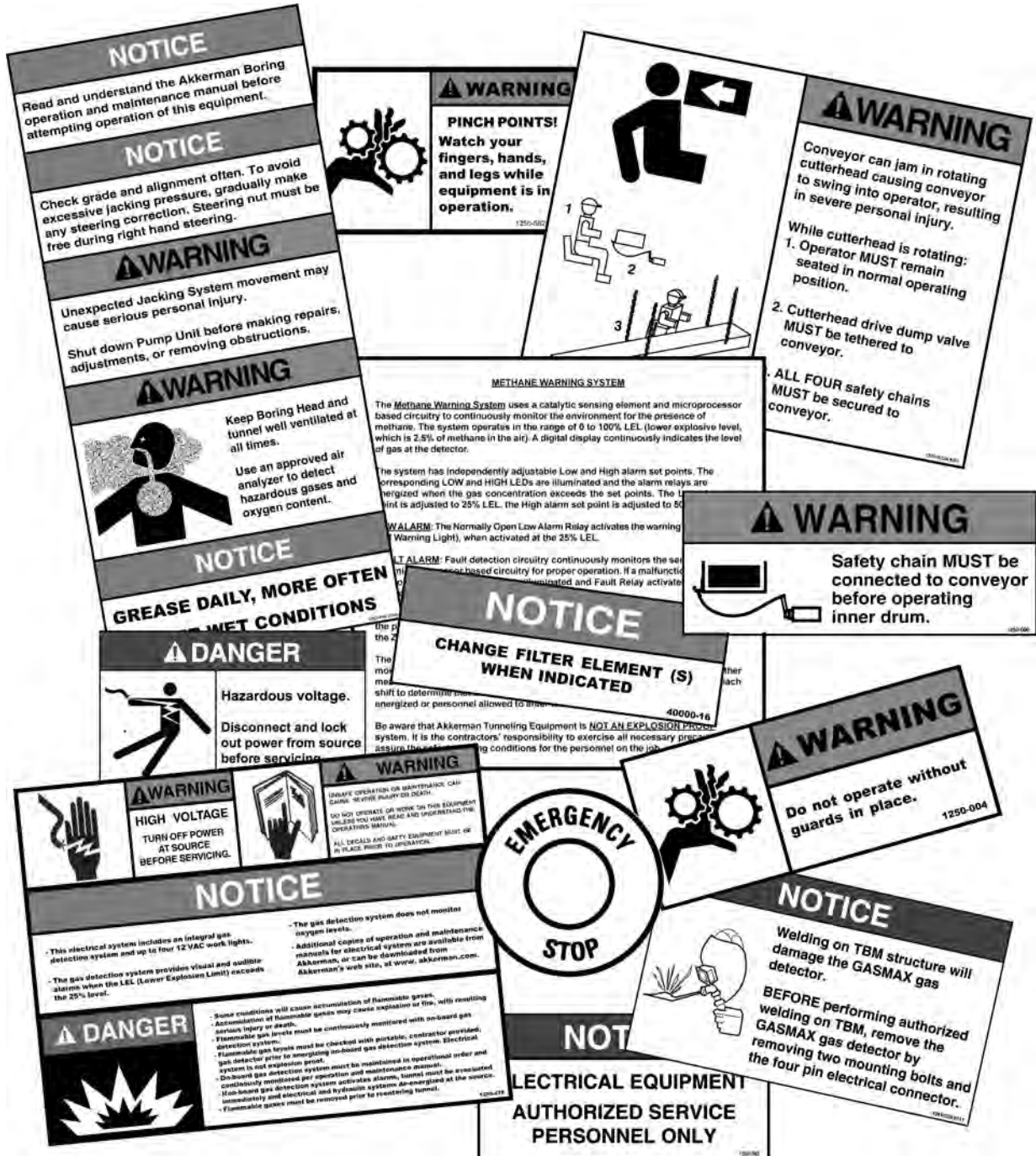

TUNNEL BORING MACHINE - 48SC - 420 - 480 - 540

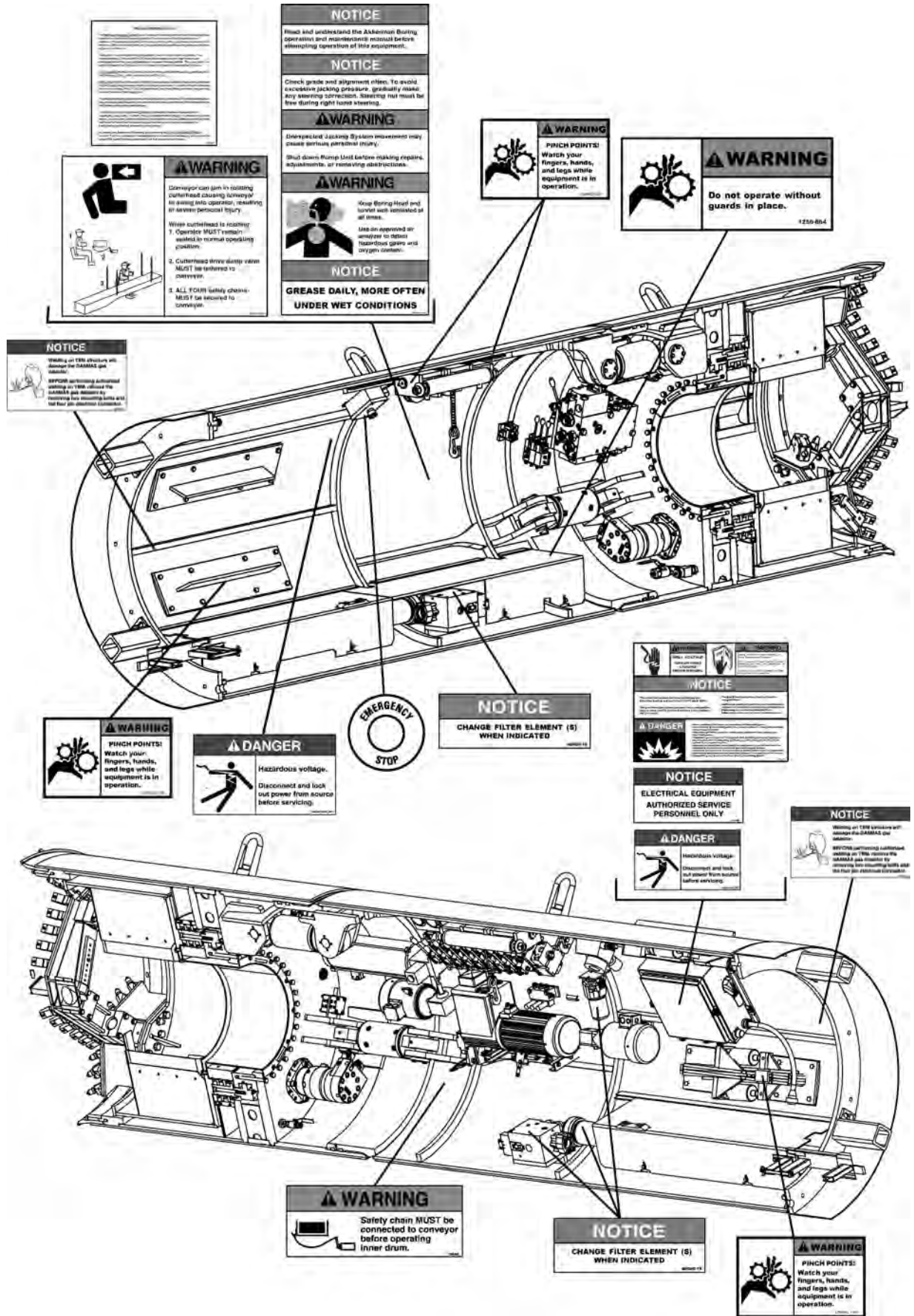

TUNNEL BORING MACHINE - 600 - 660 - 720 - 780

NOTICE
Must read and understand the Abbreviated Working description and equipment operation before entering operation of this equipment.

NOTICE
Check gear oil alignment often. To avoid excessive bearing pressure, gradually increase any bearing correction. Shaving must meet its flow during right hand turning.

WARNING
Unsprung Loading System movement may cause serious personal injury.
Shut down Pump Link before making repairs, adjustments, or removing obstructions.

WARNING
Keep footing firm and avoid use of ladders at all times.
Use an approved tie-off on all areas to which hazardous gases and oxygen content.

NOTICE
GREASE DAILY, MORE OFTEN UNDER WET CONDITIONS

WARNING
2. Gravity of cutters in rotating cuthead causing conveyor to swing into operator, resulting in severe personal injury.
While authorized to rotate:
1. Operator MUST remain seated in approved operating position.
2. Conveyors drive during speed MUST be followed to conveyor.
3. ALL FLOOR safety chains MUST be secured to conveyor.

NOTICE
Working on TBM structure will damage the DASHA gas detector.
BEFORE performing authorized working on TBM, remove the DASHA gas detector by removing the retaining pins and the two pin electrical junctions.

HAZARDOUS VOLTAGE
Hazardous voltage. Disconnect and lock out power from source before servicing.

WARNING
PINCH POINTS!
Watch your fingers, hands, and legs while equipment is in operation.

EMERGENCY STOP

WARNING
Do not operate without guards in place.

WARNING
PINCH POINTS!
Watch your fingers, hands, and legs while equipment is in operation.

NOTICE
ELECTRICAL EQUIPMENT AUTHORIZED SERVICE PERSONNEL ONLY

HAZARDOUS VOLTAGE
Hazardous voltage. Disconnect and lock out power from source before servicing.

WARNING
Safety chain MUST be connected to conveyor before operating inner drum.

NOTICE
CHANGE FILTER ELEMENT (S) WHEN INDICATED

WARNING
PINCH POINTS!
WATCH YOUR FINGER, HANDS, AND LEGS WHILE EQUIPMENT IS IN OPERATION.

NOTICE
Working on TBM structure will damage the DASHA gas detector.
BEFORE performing authorized working on TBM, remove the DASHA gas detector by removing the retaining pins and the two electrical junctions.

WARNING
PINCH POINTS!
Watch your fingers, hands, and legs while equipment is in operation.

BELT CONVEYOR

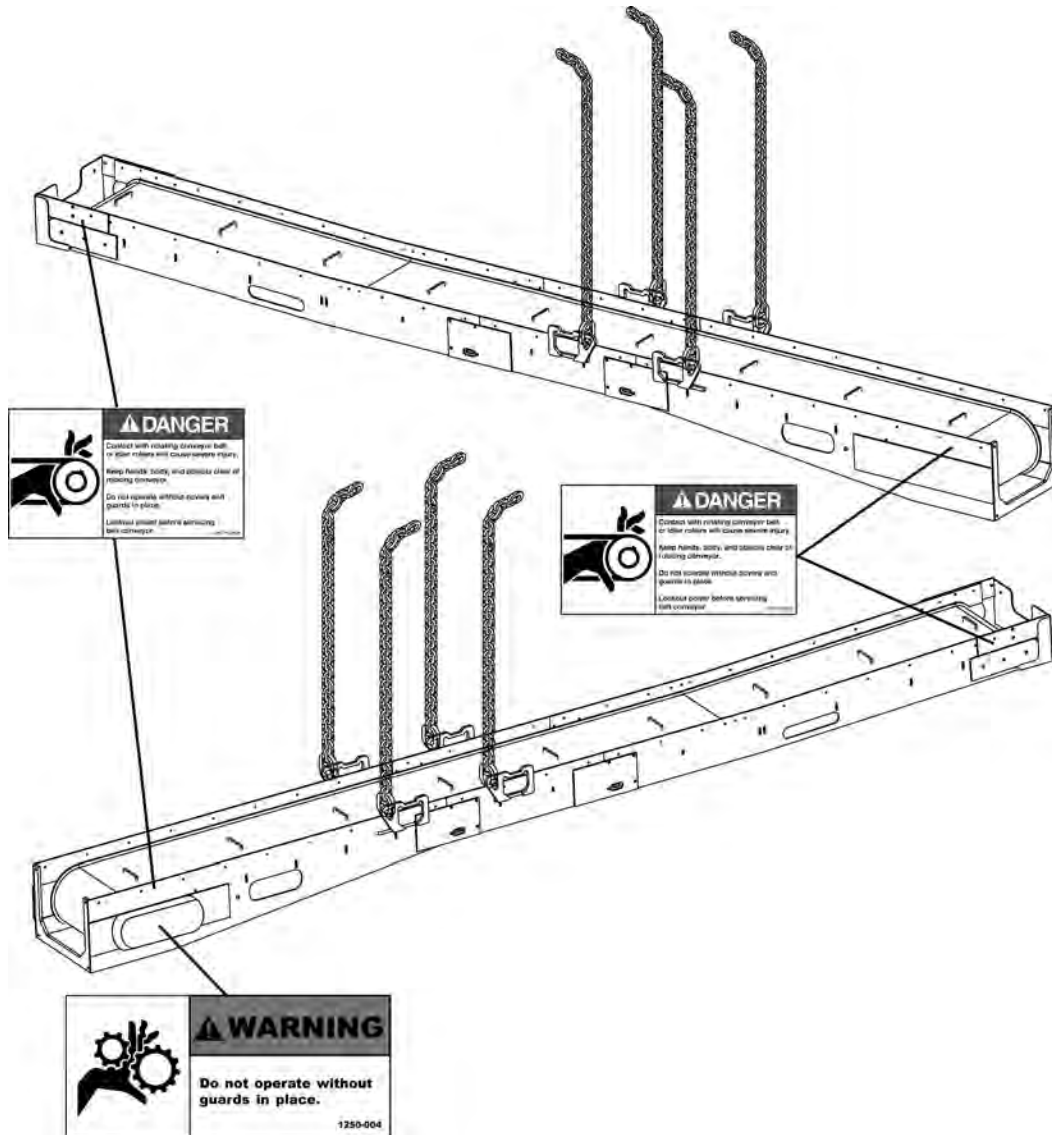

SCREW CONVEYOR

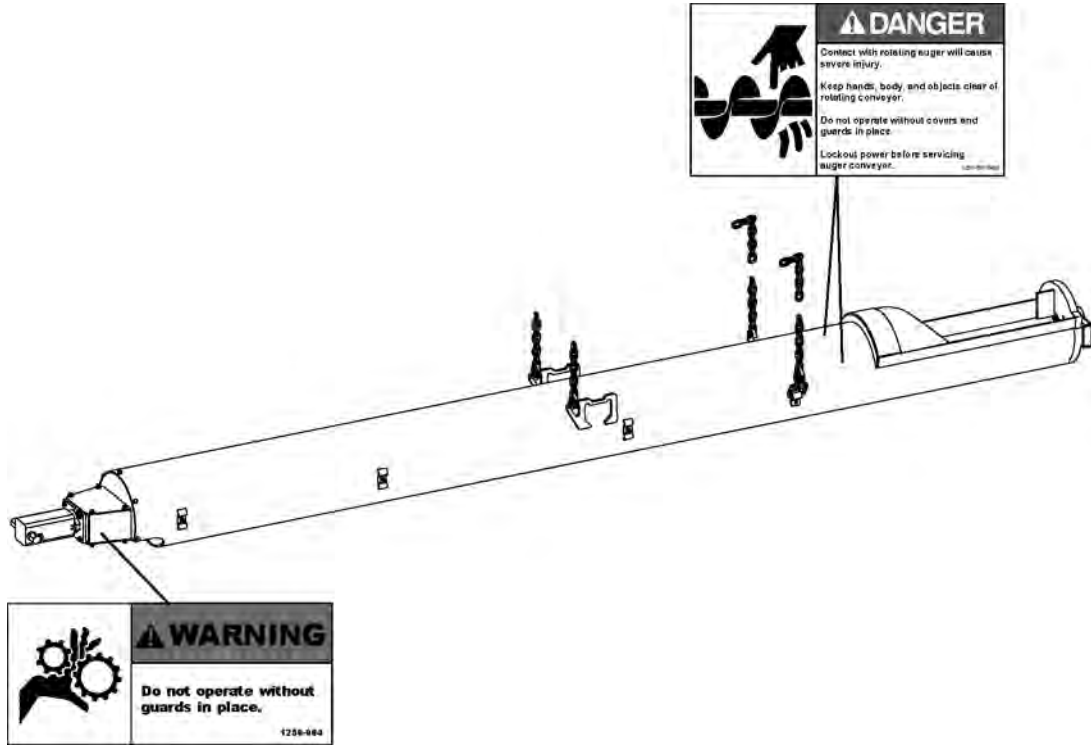

LASER SIGHT

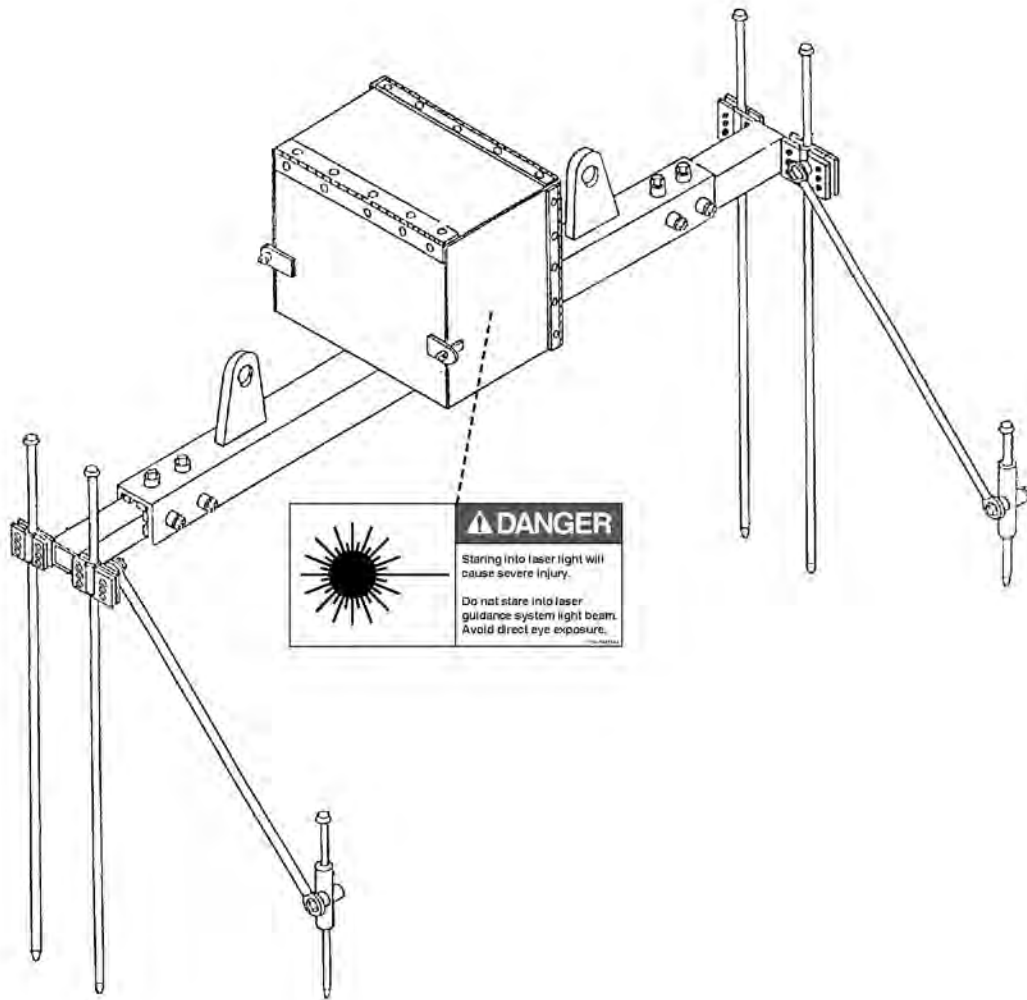

Terminology

TUNNEL BORING MACHINE - SERIES II: 48SC - 420 - 480 - 540

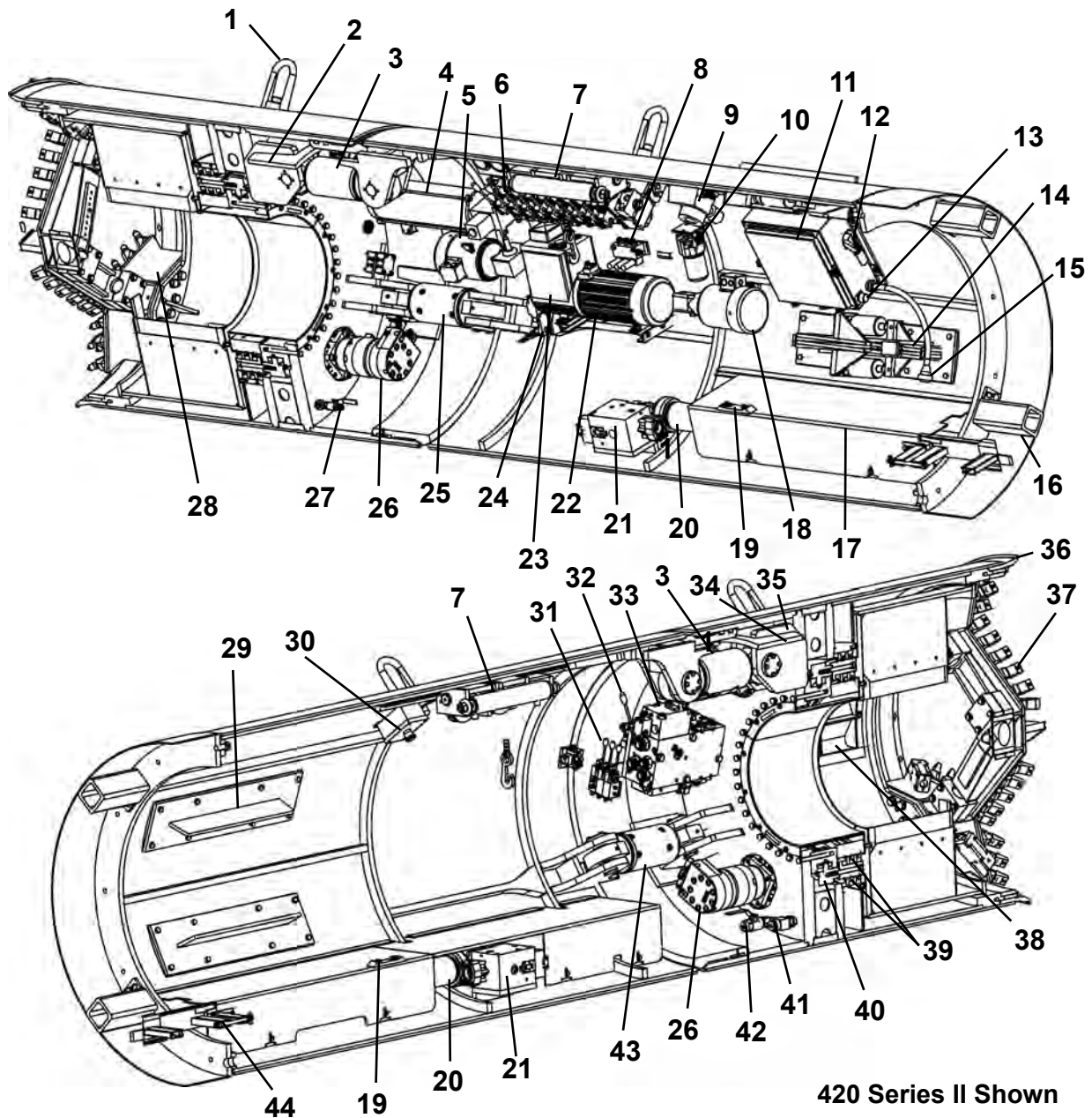

- | | | |
|------------------------------------|--------------------------------------|------------------------------------|
| 1. Lift Eye | 16. Push Block | 31. Three Bank Control |
| 2. Bearing Cavity Oil Fill Port | 17. Floor Assembly | 32. Boring Head Control |
| 3. Steering Cylinders (Top) | 18. Bearing Lube Pump | 33. Boring Head Control Manifold |
| 4. Seal Grease Reservoir | 19. Haul Unit Stop | 34. Boring Head Cavity Sight Gauge |
| 5. Seal Grease Pump | 20. Pressure Filter | 35. Boring Head Cavity Vent |
| 6. TBM Control Valve & PSI Gauges | 21. Unloading Compensator Block | 36. Cutter Ring |
| 7. Conveyor Lift Assembly | 22. Scavenging Pump | 37. Cutter Head & Teeth |
| 8. Steering Pressure Relief Valve | 23. Scavenging Pump Reservoir | 38. Dirt Scoop |
| 9. Gas Detector Horn & Strobe | 24. Conveyor Safety Switch | 39. Bearing Seals |
| 10. Bearing Oil Lube Filter | 25. Steering Cylinders (Right) | 40. Bearing |
| 11. Electrical Control Box | 26. Drive Motor | 41. Bearing Oil Magnetic Rod |
| 12. Main Power Switch | 27. Bearing Oil Cavity Shutoff Valve | 42. Bearing Oil Drain Valve |
| 13. Tunnel Power Phase OK Light | 28. Dirt Paddles | 43. Steering Cylinders (Left) |
| 14. Dirt Wing/Torque Wing | 29. Torque Wing | 44. Haul Unit Track Adapter |
| 15. 480V Incoming Power Connection | 30. Emergency Stop | |

TUNNEL BORING MACHINE - SERIES II: 600 - 660 - 720 - 780

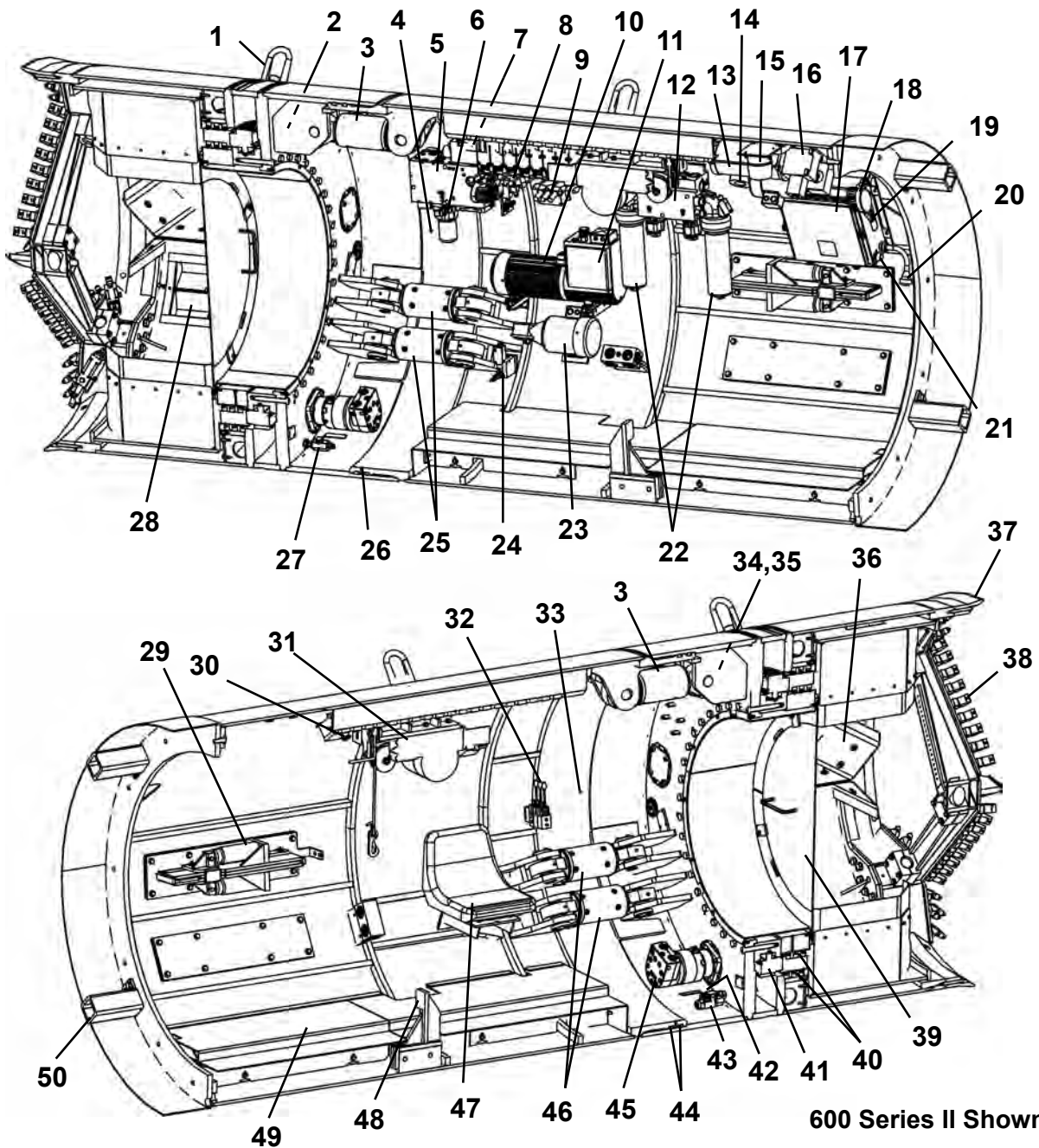

- | | | |
|---------------------------------------|--|-------------------------------|
| 1. Lift Eye | 18. Light | 35. Boring Head Cavity Vent |
| 2. Bearing Cavity Oil Fill Port | 19. Main Power Switch | 36. Dirt Paddles |
| 3. Steering Cylinders (Top) | 20. 480V Incoming Power Connection | 37. Cutter Ring |
| 4. Steering Joint-3 o'clock Grse Port | 21. Tunnel Power Phase OK Light | 38. Cutter Head & Teeth |
| 5. Boring Head Control Manifold | 22. Pressure Filter | 39. Bulkhead Seal |
| 6. Bearing Oil Lube Filter | 23. Bearing Lube Pump | 40. Bearing Seals |
| 7. Boring Head Control | 24. Conveyor Safety Switch | 41. Bearing |
| 8. TBM Control Valve & PSI Gauges | 25. Steering Cylinders (Right) | 42. Bearing Oil Magnetic Rod |
| 9. Steering Pressure Relief Valve | 26. Steering Joint-6 o'clock Grse Port | 43. Bearing Oil Drain Valve |
| 10. Scavenging Pump | 27. Bearing Oil Cavity Shutoff Valve | 44. Steering Joint Seal |
| 11. Scavenging Pump Reservoir | 28. Dirt Scoop | 45. Drive Motor |
| 12. Unloading Compensator Block | 29. Dirt Wing/Torque Wing | 46. Steering Cylinders (Left) |
| 13. Seal Grease Reservoir | 30. Emergency Stop | 47. Operator Seat |
| 14. Gas Detector | 31. Conveyor Lift Assembly | 48. Haul Unit Stop |
| 15. Gas Detector Horn & Strobe | 32. Three Bank Control | 49. Floor Assembly |
| 16. Seal Grease Pump | 33. Steering Joint-9 o'clock Grse Port | 50. Push Block |
| 17. Electrical Control Box | 34. Boring Head Cavity Sight Gauge | |

TBM CONTROL VALVES

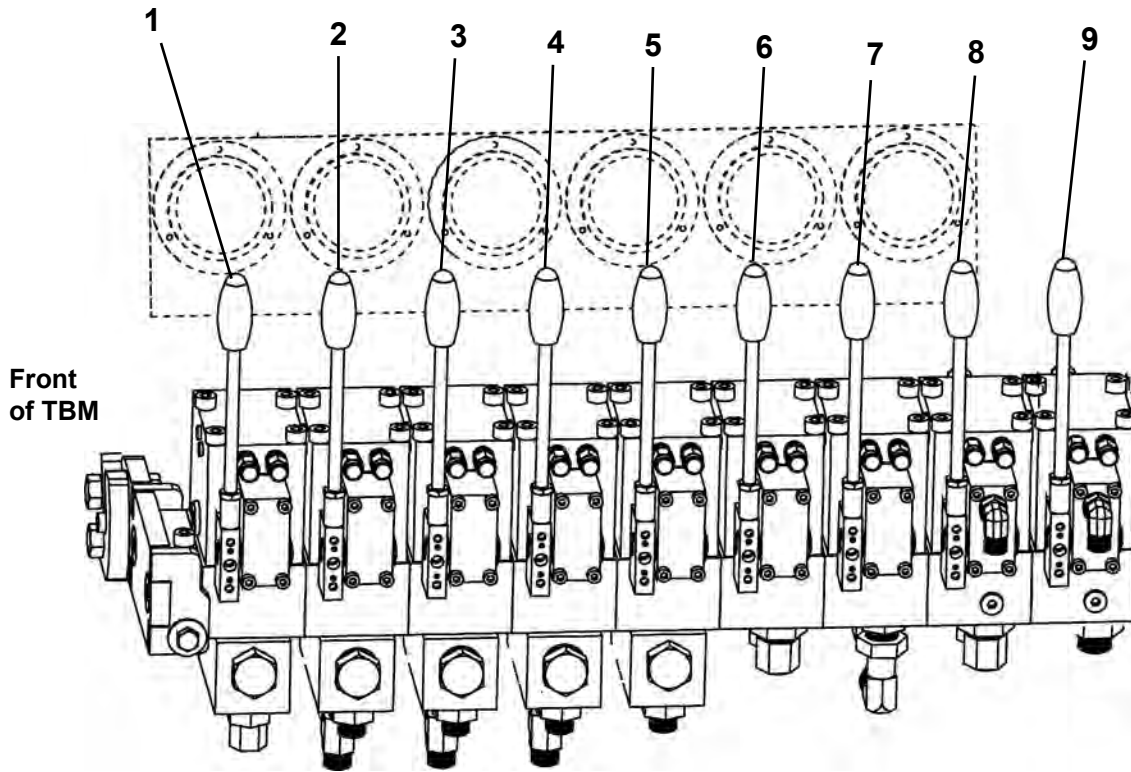

- | | |
|---------------------|--------------------------|
| 1. Closed Face | 6. Conveyor Lift |
| 2. Steering - Left | 7. Auxiliary |
| 3. Steering - Top | 8. Jacking Can Cylinders |
| 4. Steering - Right | 9. Conveyor Drive |
| 5. Dirt Wings | |

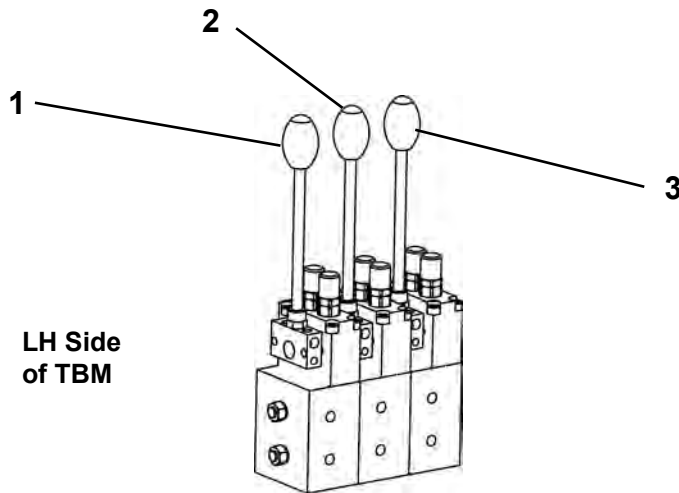

- | |
|--------------------------|
| 1. Conveyor |
| 2. Jacking Can Cylinders |
| 3. Boring Head Control |

TBM PRESSURE GAUGES

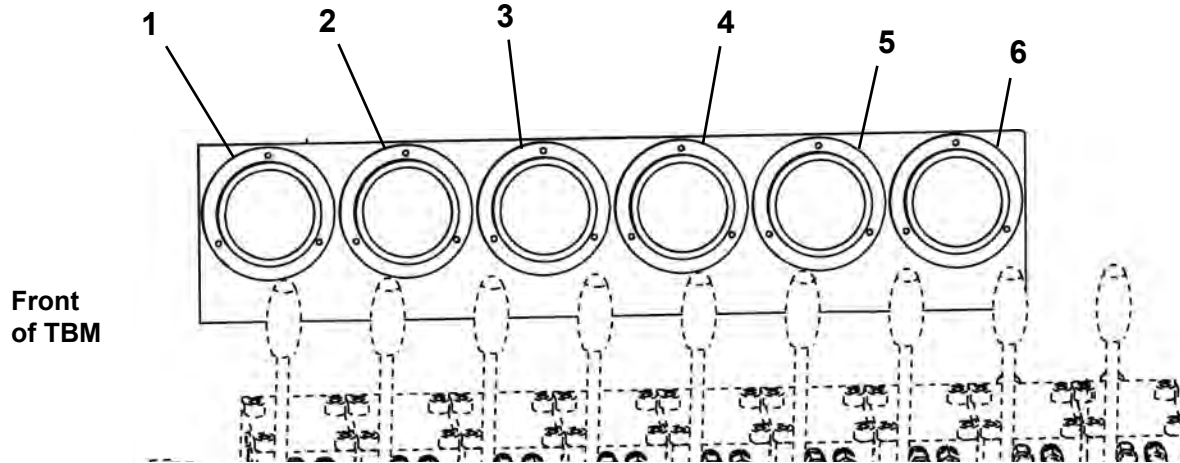

- | | |
|---------------------------------------|-------------------------------|
| 1. Steering Cylinder Pressure - Left | 4. Boring Head Pressure - CCW |
| 2. Steering Cylinder Pressure - Top | 5. Boring Head Pressure - CW |
| 3. Steering Cylinder Pressure - Right | 6. System Pressure |

CUTTER HEAD ATTACHMENTS

Quad Carbide Bar Head

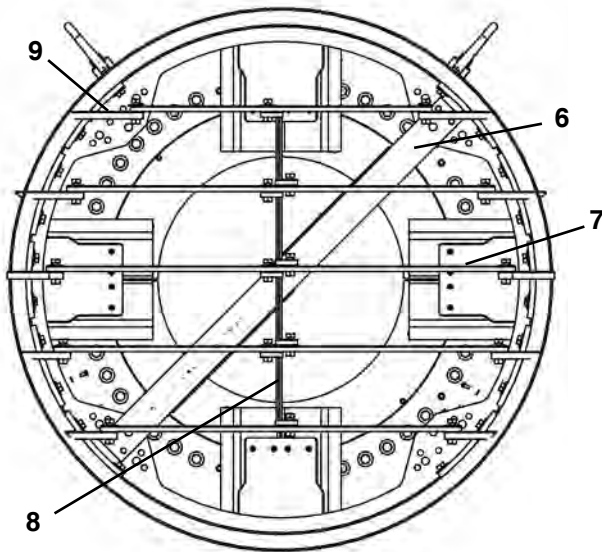
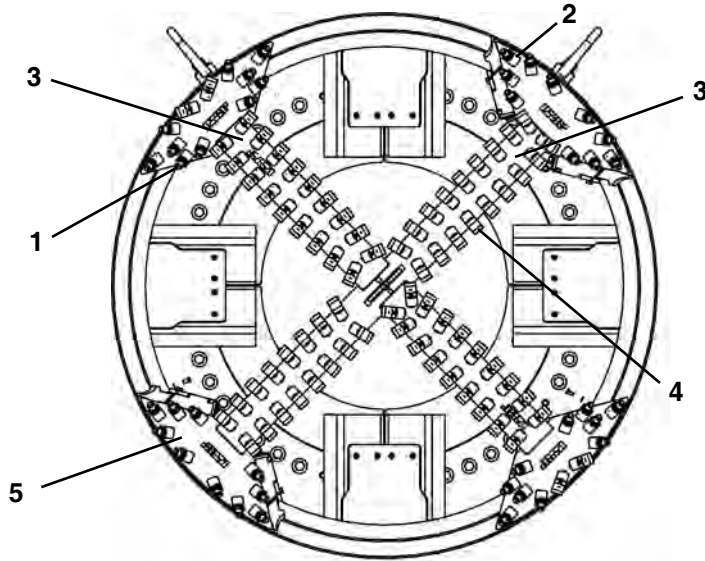

Sand Head

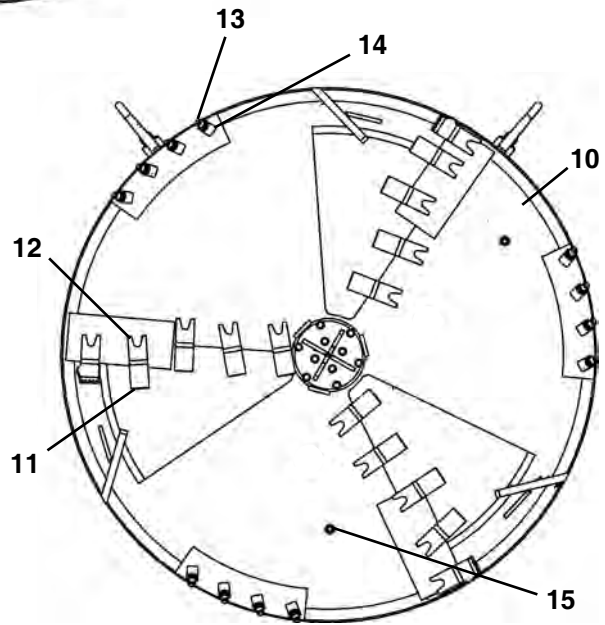

Closed Face

Quad Carbide Bar Head

- 1. Carbide Tooth
- 2. Tooth Holder
- 3. Quad Bar Weldment
- 4. Cutter Tooth
- 5. Cutter Bar Mount

Sand Head

- 6. Sand Bar Weldment
- 7. Sand Shelf
- 8. Sand Shelf Z Bracket
- 9. Sand Shelf End Bracket

Closed Face

- 10. Closed Face
- 11. Cutter Tooth
- 12. Tooth Pocket
- 13. Cutter Bit
- 14. Bit Holder
- 15. Water/Lubrication Ports

CONVEYOR - BELT

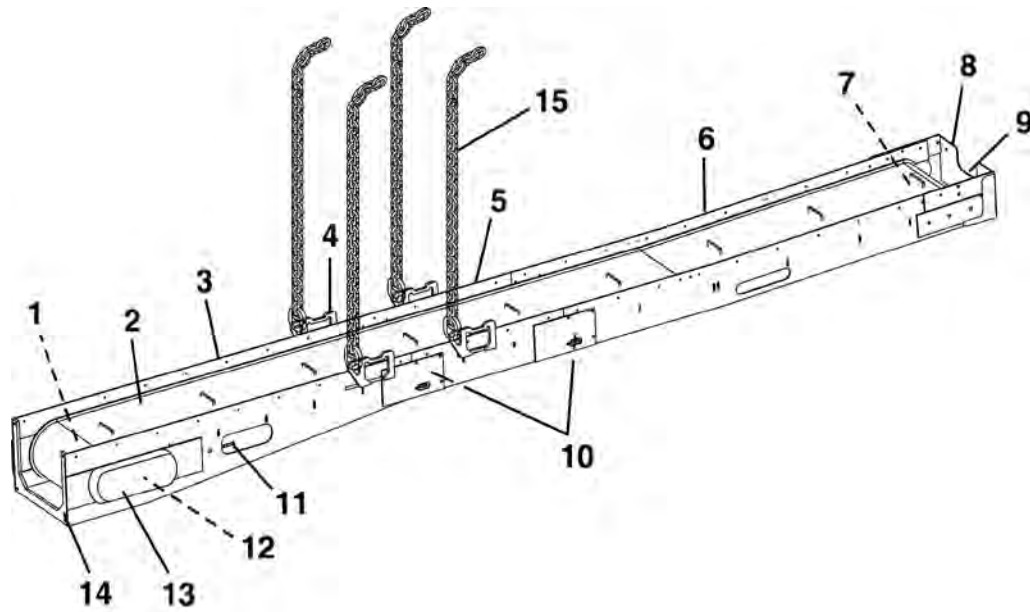

- 1. Drive Motor Frame Assembly
- 2. Belting
- 3. Drive Frame Assembly
- 4. Lift Bracket
- 5. Extension Frame Assembly

- 6. Feed Frame Assembly
- 7. Front Roller Assembly
- 8. Dirt Guard
- 9. Carrier Bearing
- 10. Idler Roller

- 11. Belt Tensioning Screw
- 12. Drive Motor & Roller Assembly
- 13. Conveyor Chain Cover
- 14. Drive Frame Free End Support
- 15. Safety Chain

CONVEYOR - SCREW

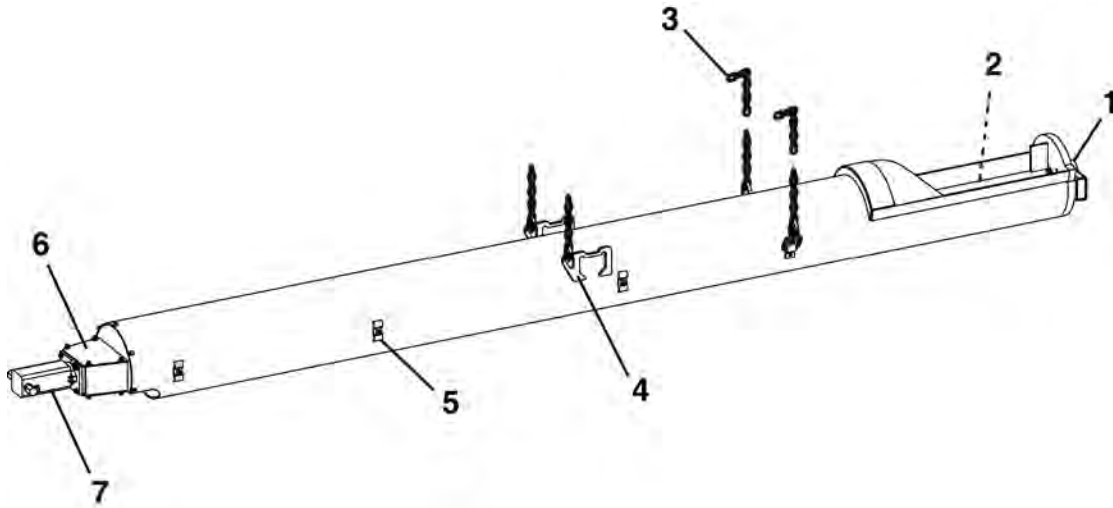

- 1. Carrier Bearing
- 2. Auger
- 3. Safety Chain
- 4. Lift Bracket

- 5. Hose Clamp
- 6. Motor Mount
- 7. Motor

LASER LIGHT STAND

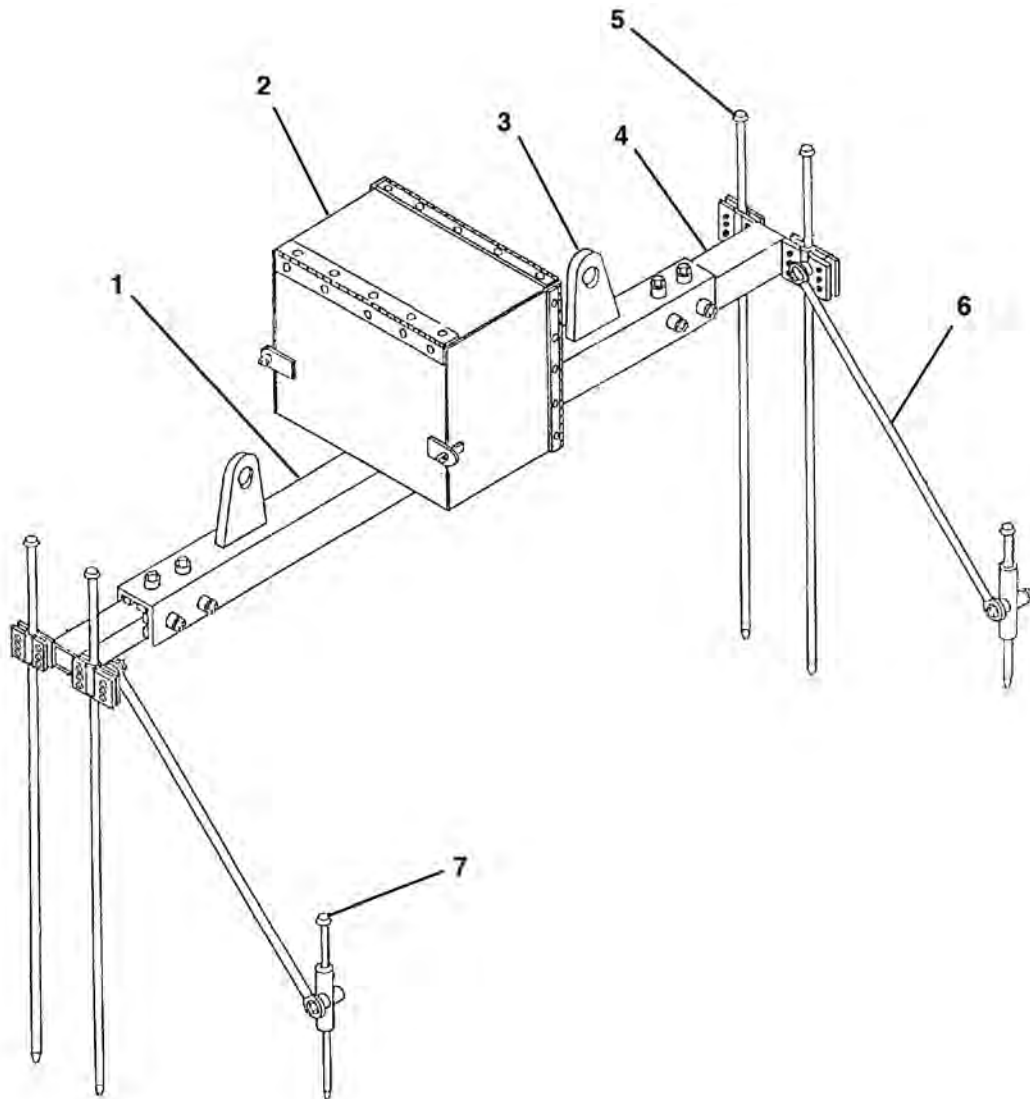

- 1. Adjustable Frame
- 2. Laser Box Assembly
- 3. Lift Bracket
- 4. Sliding Tube

- 5. Long Stake
- 6. Support Tube
- 7. Short Stake

Controls & Instruments

EMERGENCY STOP

⚠ WARNING ALL Emergency Stop buttons MUST be tested and operating properly BEFORE operating Pump Unit and TBM. Failure to do so may cause severe injury or death.

E-Stop on 5000 Series II Pump Unit

Push 5000 Series II Pump Unit Emergency Stop button (A) IN to stop all electrical and hydraulic functions on the 5000 Series II Pump Unit and the Series II TBM.

The E-Stop button will illuminate when it is pulled OUT.

The E-Stop button must be pulled out to restart operation.

NOTICE All E-Stop buttons (Pump Unit E-Stop (A), Remote Pump Unit E-Stop (B) and TBM E-Stop (C) [if equipped]) MUST be pulled out to restart operation.

The operating lights will not be functional when an E-Stop button is pushed IN.

E-Stop on Series II TBMs

Push Series II Emergency Stop button (C) IN to stop all electrical power. The hydraulic functions will continue to operate until the hydraulic controls are shut down in the pump unit.

IMPORTANT: DO NOT operate the Series II TBM without electric power. Below is the result of no electric power in the TBM:

1. The bearing oil pump will not operate therefore the bearing cavity oil will not be recirculated.
2. The gas detector is no longer functional.
3. The scavenging pump will not operate causing the excess oil in the scavenging pump reservoir to flow out of the circuit breather into the TBM.
4. The operating lights will not function.
5. The bearing seal grease pump will not operate, as a result, the bearing seals will not be greased.

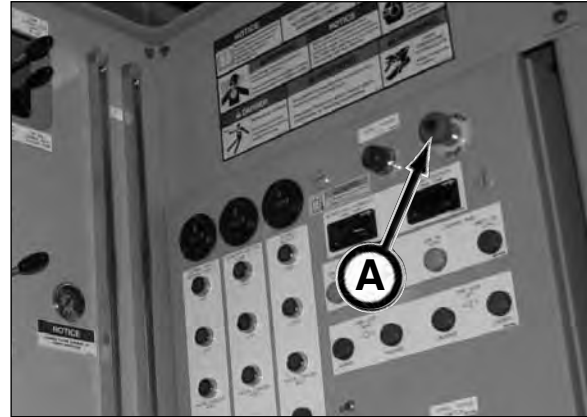

E-Stop on 5000 Series II Pump Unit

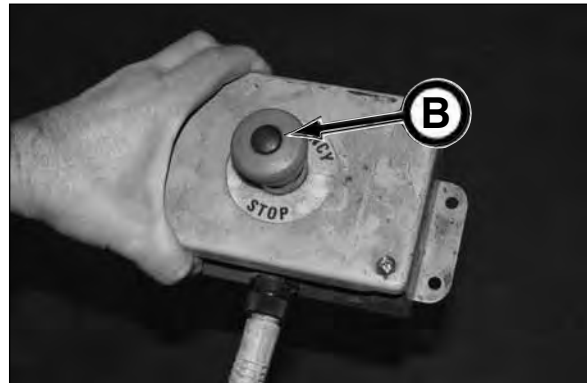

Remote E-Stop on 5000 Series II Pump Unit



E-Stop on Series II TBM

GAS DETECTOR

NOTICE Refer to Akkerman Gas Detection System Operation & Parts Manual for operation and maintenance procedures.

⚠ DANGER The gas detection system installed in the TBM, monitors only methane gas levels. **Monitoring of all gas levels is the responsibility of the contractor.** This includes the accumulation of combustible and toxic gases, and depletion of oxygen. The contractor must keep the tunnel ventilated with fresh air.

The gas detection system includes the following primary components; the gas sensor, and transmitter/relay. The Akkerman system also provides a power supply for the system, and an audible and visual alarm system.

The transmitter has a LED/LCD display, depending upon the model of your gas detector. During normal operation, the current gas concentration is displayed. It is also used to display/scroll messages when in calibration mode or when a sensor fault is detected.

The four magnetic sensor controls are activated by a magnetic wand. Holding the magnetic wand over one of the magnetic sensor targets will activate that sensor. It may take several seconds for the magnetic sensor to activate. If the transmitter does not respond, remove the magnetic wand for several seconds and try again.

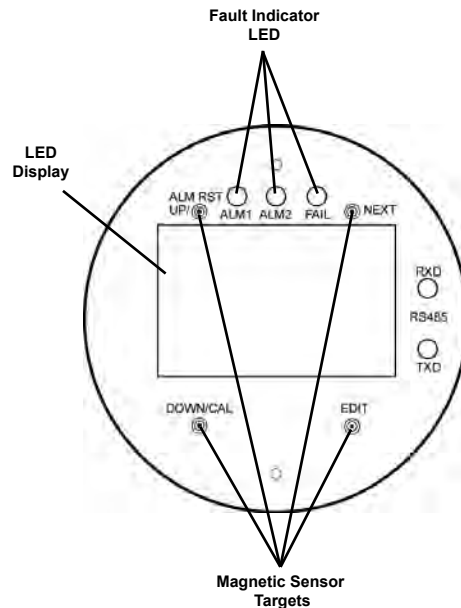

GDS GasMax II Transmitter Display

MAIN POWER SWITCH

⚠ DANGER Hazardous voltage. Disconnect and lock out/tag out power from source before servicing.

⚠ DANGER If high voltage cables or cable connections are damaged, contact with cables/connections may result in electrical shock causing severe injury or death. Disconnect and lock out/tag out power from source before servicing.

⚠ WARNING Any electrical work performed on the pump unit or TBM must be completed by a certified electrician.

NOTICE All Emergency Stop buttons must be pulled out to restart operation.

Use the main power switch (A) to provide power from the pump unit to the TBM electrical components as follows:

1. With the power cables properly installed on the 5000 Series II Pump Unit and the input power in proper phase, lock out, tag out power on the pump unit and external power source.
2. Install the 480V power cable from the power unit to the Incoming Power connection (B) on the TBM electrical box.
3. Pull out all E-Stop buttons.
4. Turn on external power source and pump unit with proper phase.
5. Check the Tunnel Power Phase OK light (C). If the light is illuminated, turn on main power switch (A).
6. Once main power switch is turned to the ON position, the 480V power provides power to the bearing lubrication pump and the scavenging pump and seal grease pump. The 480V circuit also powers a transformer inside the electrical box which converts the 480V power to 24 VDC. The 24 VDC circuit provides power for the lights, gas detector and the conveyor safety valve circuit.

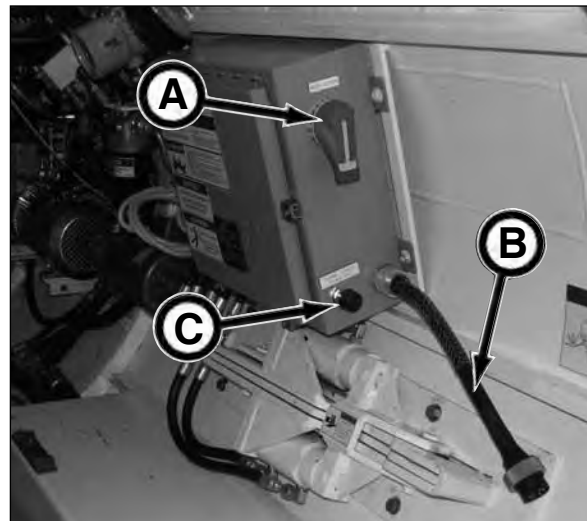

LUBE & GREASE MANUAL POWER SWITCH

As the cutter head rotates, the bearing oil pump (A) automatically recirculates oil from the bearing, through the bearing cavity, the pump, filter, bearing oil manifold and then back to into the bearing.

The grease pump (B) also automatically operates when the cutter head rotates. Grease is pumped to the bearing seals to prevent dirt from entering the seal area.

If it is desired to run the bearing oil and grease pumps without the cutter head rotating, the bearing and grease pumps can be manually powered with the Lube & Grease Manual Power switch (C).

NOTICE Check the boring grease pressure gauge (D) for any indication that the pump is either not working properly, the in-line filter is plugged, or a grease line is clogged. If there is no pressure on the gauge, the reservoir is out of grease or the pump is not operating.

NOTICE Check the seal grease reservoir daily to be sure there is ample amount of grease in the reservoir for the day.

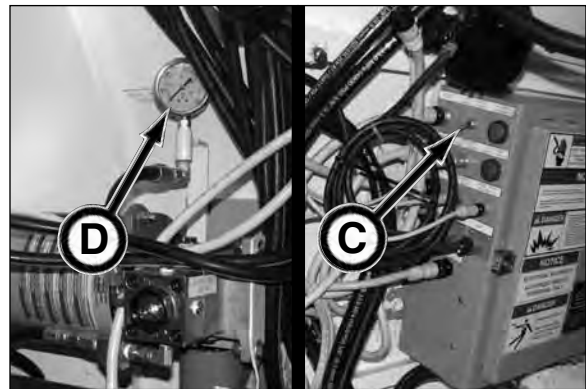
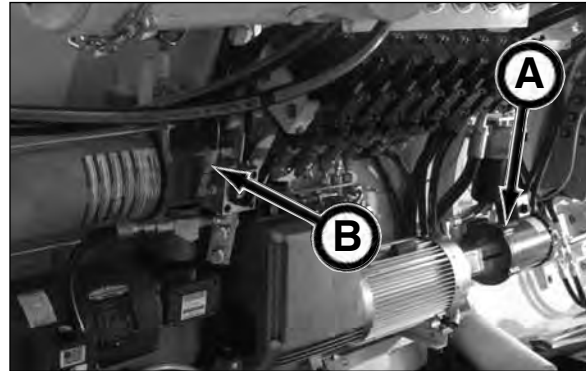

CONVEYOR SAFETY SWITCH

The conveyor safety switch light (E) will illuminate when the tethered chain to the conveyor is pulled by excessive conveyor movement and trips the conveyor safety switch (F).

When the conveyor safety switch trips, the cutter head stops rotating.

To reset the conveyor safety switch and to resume cutter head rotation, flip the valve lever down to the operation position (G).

Location (H) indicates the valve lever in the tripped position.

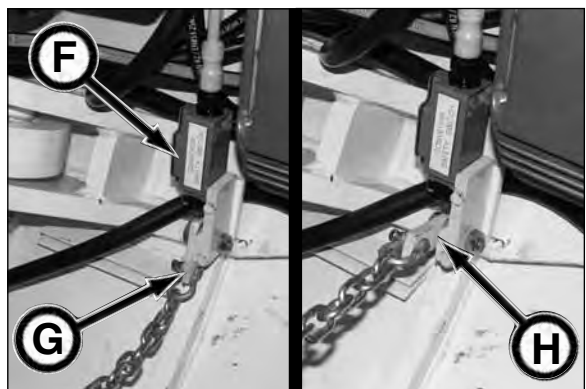
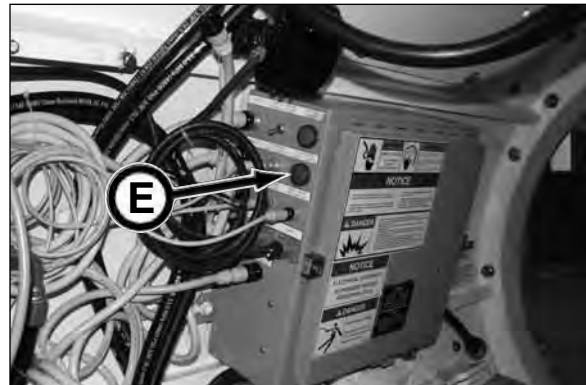

Operation Position

Tripped Position

TUNNEL POWER PHASE OK LIGHT

⚠ WARNING Any electrical work completed on the pump unit or TBM must be performed by a certified electrician.

The input power is monitored for proper three phase electrical power.

If the Tunnel Power Phase OK light (A) is ON, this indicates that the external power source and pump unit phase power is installed correctly and that the main power in the TBM can be turned on.

If the light does not illuminate, check the phase power from the external power source and pump unit. Refer to your 5000 Series II Jacking System Operator's Manual, Phase Error Light in section 4, Controls and Instruments to correct the input phase.

IMPORTANT: DO NOT start up electric components if the Tunnel Power Phase OK light is not illuminated. Doing so will run components backwards causing damage.

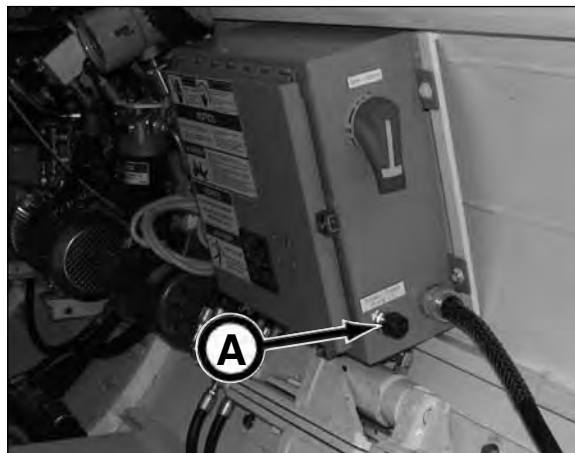

24 VDC POWER ON LIGHT

The 24 VDC Power On light (B) will illuminate when converted power from the 480V circuit is available.

The 24 VDC circuit provides power for the lights, gas detector and conveyor safety valve circuit.

⚠ WARNING If light is not illuminated when tunnel power is on, have a certified electrician troubleshoot and resolve the problem before continuing to operate TBM. Failure to do so could cause loss of safety functions and seal damage.

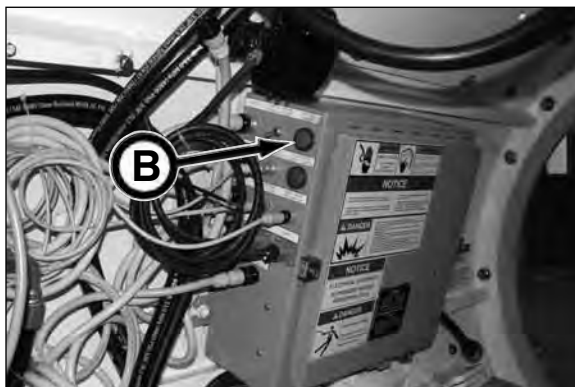

SCAVENGING PUMP

The scavenging pump (C) displaces low pressure case drain oil from the pilot circuit valves and drive motors. The pump will automatically pump the oil from the scavenging pump reservoir (D) to the return line once it reaches the high level sensor. When the oil level reaches the low level sensor, the pump will shut off preventing pump cavitation.

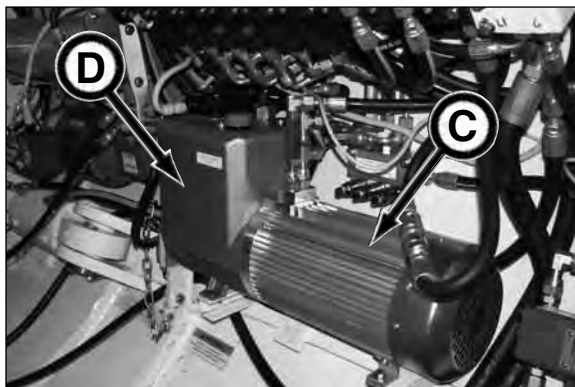

CONVEYOR CONTROLS

Conveyor Lift

The conveyor lift control (A) on the TBM control valve raises or lowers the conveyor. Move the control lever as follows:

- UP - raises conveyor
- DOWN - lowers conveyor

NOTICE

Do not over-raise the conveyor. If conveyor is completely raised when the steering cylinders are retracted, damage will result to conveyor and/or conveyor cables.



Conveyor Drive & Speed Control

The conveyor drive lever (B) controls the forward/reverse direction and speed of the belt or auger conveyor.

The further the lever is moved from neutral, the faster the conveyor belt or auger will move. This control also is equipped with a friction detent, so the lever will remain in the desired position until you move it back to neutral position.

Move the lever as follows:

- PUSH - towards reception shaft
- PULL - towards launch shaft

Control the speed of the conveyor so when the spoils drop on the conveyor, they do not pile up on the belt or in the auger. A change in TBM advancement rate or ground conditions will require an adjustment in the conveyor speed.

WARNING

Running the conveyor too fast can cause severe injury from flying debris and cause possible machine damage. Slow the conveyor speed so there is continual controlled movement of the spoils into the dirt bucket.

An additional conveyor drive & speed control (C) is located on the 9 bank valve above the operator, though this control is not equipped with the friction detent function.

Move the lever as follows:

- UP - towards reception shaft
- DOWN - towards launch shaft

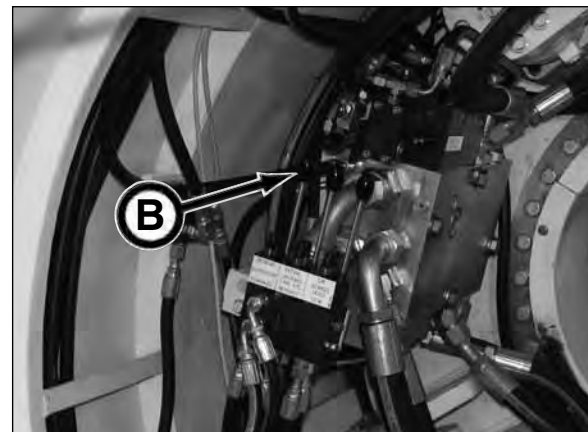

BORING HEAD CONTROL

The Boring Head Control lever (A) controls the cutter head rotation. Move the lever as follows:

- Pull - reverse (CCW rotation*) direction
- Push - forward (CW rotation*) direction

* as viewed from operator seat, inside TBM

NOTICE Verify the control direction before mining.

The further the lever is moved from neutral, the faster the cutter head will rotate. The lever is a spring centered control, therefore when control is released the control will move to neutral.

The TBM is equipped with a redundant boring head control (B) to be used for troubleshooting purposes only. Control lever (B) should be removed before mining to prevent accidental boring head rotation with this control.

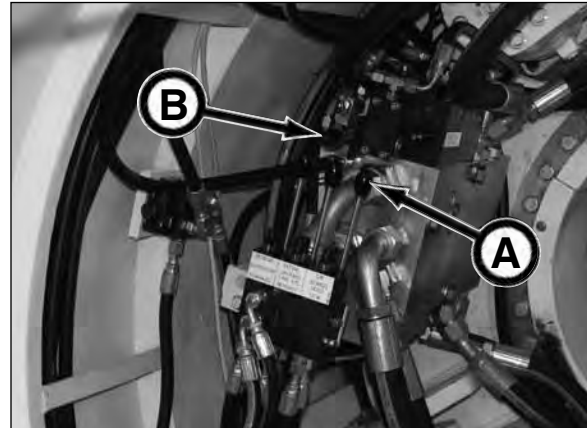

STEERING CONTROLS

The steering cylinder control levers (A, B, C) on the TBM control valve regulate the movement of the steering cylinders.

When steering corrections are necessary, be sure to **make ONLY minor adjustments over several feet**. Making more extreme steering adjustments will increase the jacking forces due to the front and trailing sections are not in parallel.

At initial start up, the steering cylinders should all be set at the 50% cylinder extension position:

- 48SC, 420, 480, 540, 600: **2.0" (51 mm)**
- 660, 720, 780: **3.0" (76 mm)**

Move steering cylinders as follows:

Steer UP

Extend the left (A) and right (C) cylinders the same amount or retract the top (B) cylinders.

Steer DOWN

Extend the top (B) cylinders or retract the left (A) and right (C) cylinders the same amount.

Steer LEFT

Extend the right (C) and retract the left (A) cylinders the same amount or;
Extend the right (C) cylinders and then the top (B) cylinders half the amount of the right cylinders.

Steer RIGHT

Extend the left (A) and retract the right (C) cylinders the same amount or;
Extend the left (A) cylinders and then the top (B) cylinders half the amount of the left cylinders.

PRESSURE GAUGES

The Steering PSI gauges show the active pressure in the cylinders. Pressures may exceed 3,000 psi due to high jacking pressure because of hard ground conditions or over advancement by the pump unit operator.

IMPORTANT: During TBM advancement, DO NOT EXCEED the maximum rated steering cylinder pressure (see below). Doing so will cause hydraulic component, main bearing and structural damage.

48SC 4,500 PSI	420 5,000 PSI
480 4,400 PSI	540 4,200 PSI
600 5,000 PSI	660 4,100 PSI
720 4,800 PSI	780 4,100 PSI

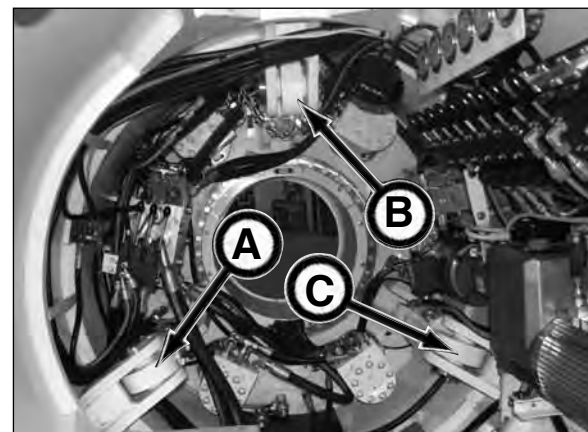
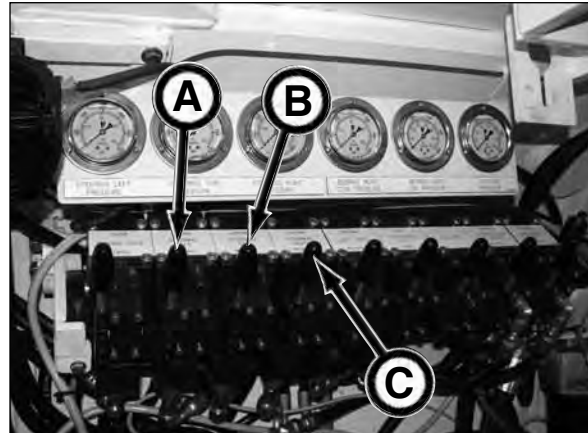

420 Series II



Steering Cylinder Pressure - Left (D)
Steering Cylinder Pressure - Top (E)
Steering Cylinder Pressure - Right (F)
System Pressure (G)

TORQUE/DIRT WING CONTROL

The torque/dirt wings (A) are used to control the TBM roll. If the TBM rolls 1/4 to 1/2" (6.35 to 12.7 mm) from level, the torque wings or dirt wings need to be extended.

There are various dirt wing configurations available for installation on the TBM. Contact your Akkerman Aftermarket Support representative for more information.

Torque wings are straight (non-directional) fins that help stabilize the TBM roll by holding the position of the TBM. If the TBM roll is excessive, extend the torque wings and if necessary, change the direction of the cutter head rotation as needed to control the roll.

Dirt wings are directional (CW or CCW) fins to help control the roll without the need to change the cutter head rotation.

Extend Torque/Dirt Wings (B)

Pull control lever (B) DOWN until the torque/dirt wings are fully extended. The torque/dirt wings are fully extended when the system pressure reads 2,800 - 3,000 psi.

Retract Torque/Dirt Wings (B)

Push control lever (B) UP until torque/dirt wings are fully retracted.

Use the torque wings/dirt wings as needed until the TBM roll is back to level position.

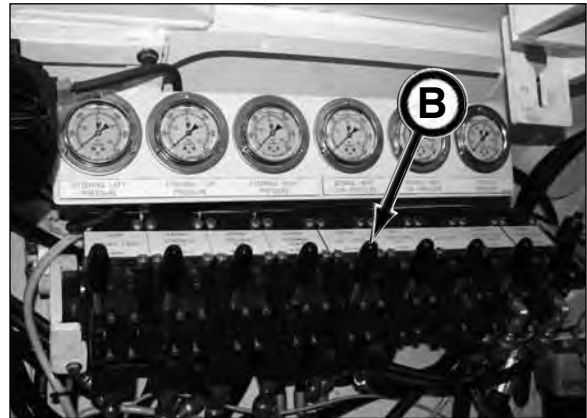
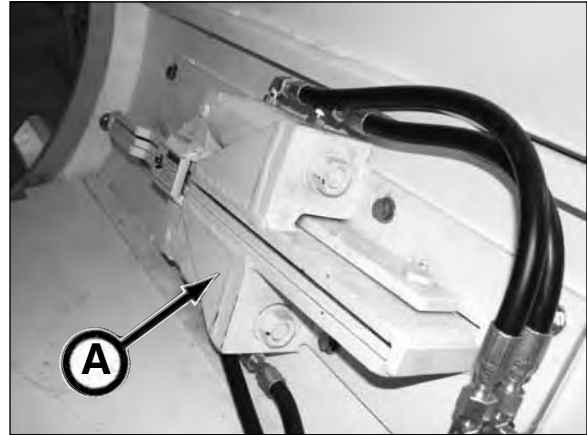

JACKING CAN CYLINDER CONTROL

If your TBM is equipped with a jacking can, the jacking can cylinder control (C or D) will regulate the jacking can cylinders.

Move the control lever as follows:

- FORWARD - extends jacking can cylinders
- BACK - retracts jacking can cylinders

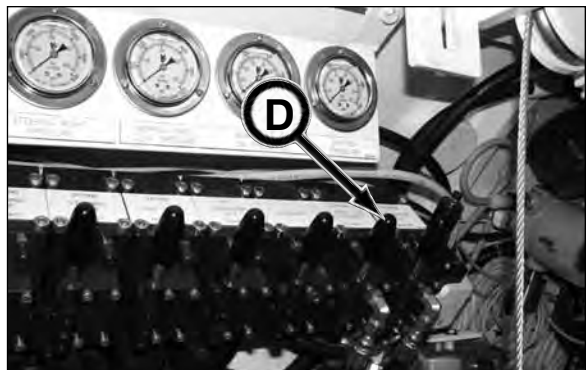
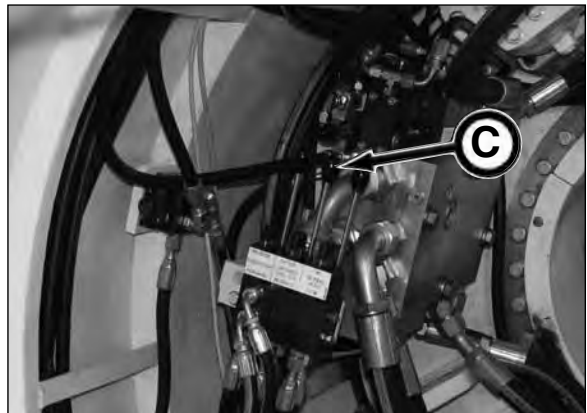

Move the control lever as follows:

- UP - extends jacking can cylinders
- DOWN - retracts jacking can cylinders

CLOSED FACE OR AUXILIARY CONTROL

The Closed Face control lever (A) controls the opening and closing of the doors on the optional closed face cutter head attachment. Used in unstable ground conditions, the hydraulically operated doors control subsidence of loose soil while excavating the ground.

A lubrication system (two water/lubrication ports on cutter head) is equipped on the closed face attachment to provide a method to lubricate the face if needed.

Move the control lever as follows:

- UP - closes doors
- DOWN - opens doors

NOTICE

For more information and operating guidelines, refer to Using Closed Face or Auxiliary Control in section 6, Operation of this manual.

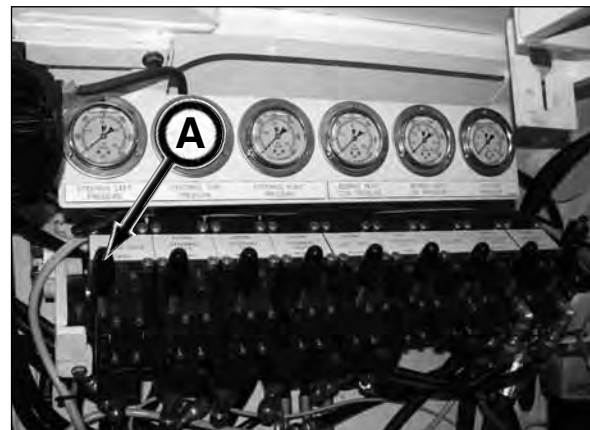

PRESSURE GAUGES

There are seven hydraulic pressure gauges installed on your tunnel boring machine for monitoring the various TBM pressures.

- A - Steering Cylinder PSI - Left
- B - Steering Cylinder PSI - Top
- C - Steering Cylinder PSI - Right
- D - Boring Head Pressure - CCW
- E - Boring Head Pressure - CW
- F - System Pressure
- G - Boring Grease Pressure

Steering Cylinder Pressure (A, B, C)

The Steering PSI gauges show the active pressure in the cylinders. Pressures may exceed 3,000 psi due to high jacking pressure because of hard ground conditions or over advancement by the pump unit operator.

IMPORTANT: During TBM advancement, DO NOT EXCEED the maximum rated steering cylinder pressure (see below). Doing so will cause hydraulic component, main bearing and structural damage.

48SC 4,500 PSI	420 5,000 PSI
480 4,400 PSI	540 4,200 PSI
600 5,000 PSI	660 4,100 PSI
720 4,800 PSI	780 4,100 PSI

Boring Head Rotation Pressure (D, E)

The maximum boring head rotation pressure is 3,000 psi or 5,000 psi depending on the hydraulic supply source.

System Pressure (F)

The system pressure gauge monitors the inlet pressure to the 9 bank control valve. It displays the pressure for the conveyor, conveyor lift, dirt wings, steering cylinders, closed face and jacking can cylinders.

The maximum system pressure for the conveyor, conveyor lift, dirt wings and closed face is 3,000 psi. The maximum system pressure for the steering cylinders and jacking can is 3,000 psi or 5,000 psi depending on the hydraulic supply source.

Boring Grease Pressure (G)

If the cutterhead is rotating or if the Lube & Grease Pump Manual Switch is in the ON position, the boring grease pressure gauge will display minimal pressure (for example, 500 psi). If the grease in-line filter is plugged or a grease line is clogged, the pressure will display a much higher pressure. If there is no pressure on the gauge, the reservoir is out of grease or the pump is not operating.

NOTICE

NEVER operate TBM if a filter or grease line or oil line is plugged. Doing so will introduce contamination in the bearing cavity resulting in seal, seal surface and bearing damage.

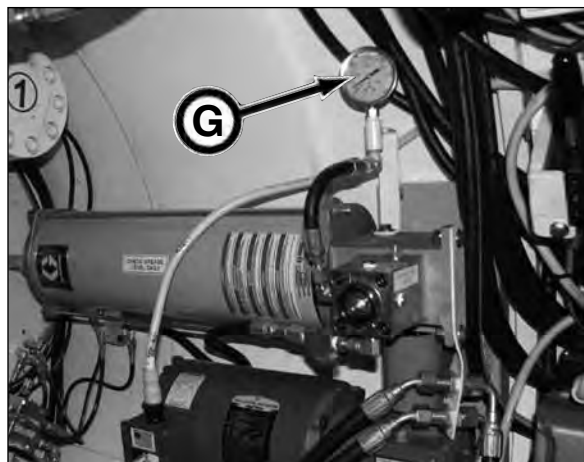
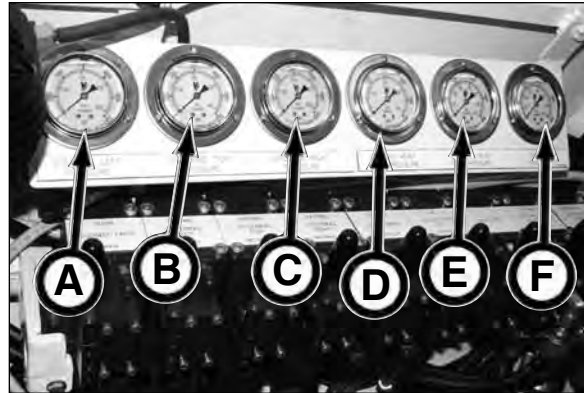

420 Series II

PRESSURE FILTER INDICATORS

The pressure filters on your TBM, filter the oil from the pump unit going into the TBM. To prevent under or over servicing of the hydraulic filter elements, a filter indicator (A) is installed with each filter assembly (B). There are **two** pressure filter assemblies installed on your TBM and are located under the floor assemblies.

When the filter indicator displays a green band, the filters are functioning properly.

When the filter indicator displays a red band, the filter requires replacement.

NOTICE The filter indicator may display a red band at initial start-up until the oil reaches normal operating temperature. If the indicator continues to display the red band after reaching normal operating temperature, replace filter to prevent contamination.

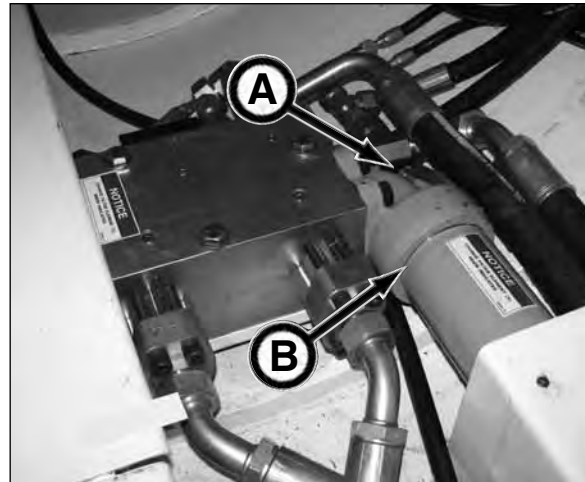

420 Series II

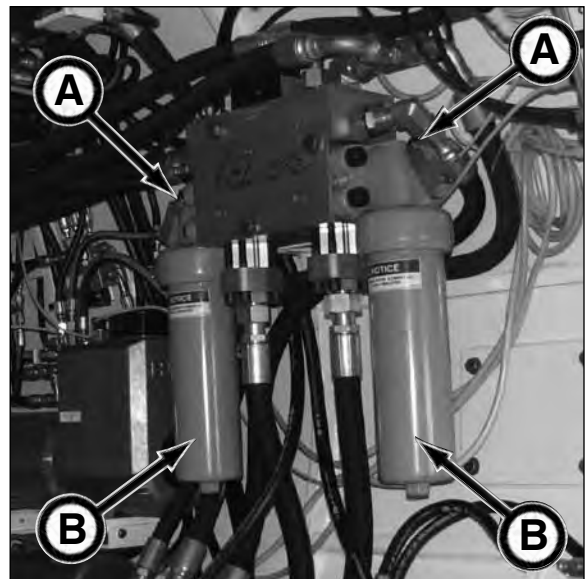

600 Series II

BEARING OIL LUBE FILTER INDICATOR

As the cutter head rotates, the bearing oil pump automatically recirculates oil from the bearing cavity, through the pump, filter, bearing oil manifold and then back to the bearing cavity.

To prevent under or over servicing of the bearing oil lube filter (C), a filter indicator (D) is installed on the filter assembly (E).

A red band will appear when the filter requires replacement.

NOTICE The red band may display at initial start-up until the oil reaches normal operating temperature. If the red band continues to display after reaching normal operating temperature, replace filter to prevent contamination.

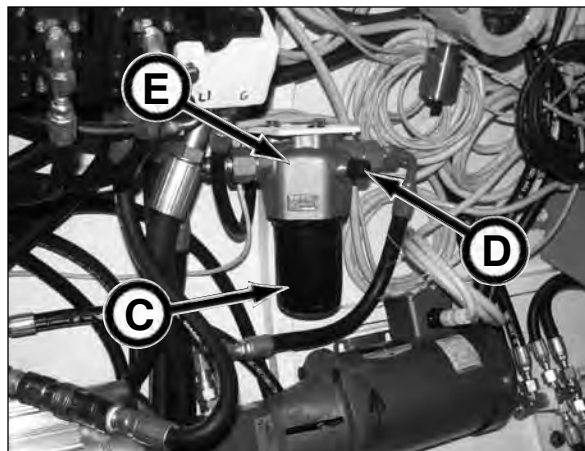

Pre-Start Inspection

⚠ WARNING

Do not operate this equipment until you read, study, and understand this manual and your haul unit, gas detection system, jacking frame, and power unit operation manuals. A daily inspection of the equipment must be performed to prevent severe personal injury or death and equipment damage.

The contractor is fully responsible for the safety of all personnel on the job site. Check with the contractor that all site preparation requirements are in place. Be sure to comply with all OSHA regulations, such as: an active safety program is in practice, a confined space permit (if needed) is issued, personal protective equipment is being worn; flammable, combustible, and hazardous materials are properly stored; and a lockout/tagout procedure is in place.

Use the following checklist ✓ as a guide for your daily pre-start inspection.

	1. Use "ONE-CALL" notification to check for buried utility lines prior to tunneling.
	2. Check the excavated launch and reception shafts for proper shoring or bracing to prevent slides or cave-ins.
	3. Thoroughly clean equipment of mud and dirt. Keep job site clean and organized.
	4. Check condition of personal protective equipment. Replace equipment if defective.
	5. Contractor is responsible for all personnel to wear proper protective equipment on the job site.
	6. Remove combustible or flammable materials from equipment. Store materials properly.
	7. Test Emergency Stop button on TBM and power unit for proper operation at the start of each shift.
	8. Test air monitoring and ventilation detectors for proper operation.
	9. Thoroughly inspect all equipment for damage, including loose or missing hardware. Repair or replace before operating.
	10. Be sure all covers and guards are in place before operation.
	11. Check electrical lines for frayed, damaged, or worn insulation or wires. Replace damaged or worn electrical lines/connections.
	12. Check for fluid leaks. Repair leak or replace components.
	13. BEFORE starting, the phase power MUST be installed correctly. Otherwise damage will occur to components.
	14. Perform all lubrication and maintenance procedures. Refer to Section 9, Periodic Maintenance.
	15. Test each function and control to ensure correct operation.
	16. Check hydraulic hoses and lines for leaks, wear and/or damage. Replace any defective hoses and/or lines.
	17. Check grease level in seal grease container. Add as needed.
	18. Perform pre-start inspection on your equipment. Refer to your equipment's operator's manual.
	19. Conveyor MUST be secured with four safety chains to conveyor bracket in TBM, and chain from conveyor safety valve must be tethered to conveyor.
	20. Test the electrical motors for proper rotation prior to operating the pump unit or power pack.
	21. Decals must be clean and legible.
	22. Be sure bearing oil lube pump, seal grease pump and scavenging pump are functioning properly.
	23. Steering joint must be fully lubricated prior to startup.
	24. BEFORE starting, ALL controls must be in the OFF or neutral position.

NOTES

Operation

OPERATING GUIDELINES

⚠ WARNING Do not operate this equipment until you read, study, and understand this manual and your haul unit, gas detection system, jacking frame, and power unit operation manuals. Failure to do so, could result in severe personal injury or death.

1. Before operating, read and understand the Safety, Pre-Start Inspection, Operation and Maintenance sections.
2. Do not operate this equipment while under the influence of alcohol, drugs, or medication.
3. Follow all Federal, State, and Local safety regulations and procedures.
4. Be sure OSHA prescribed safety protective equipment is being worn by all personnel.
5. Be sure the area is safe for operation. Keep worksite clean and orderly.
6. NEVER operate equipment if it has been engulfed with water. Contact your Akkerman Aftermarket Support representative for proper procedures on how to restore equipment for operation.
7. Have a fully charged fire extinguisher on the job site at all times.
8. Once survey is complete, perform a general visual inspection of the survey line to make sure it is in the same direction as the project bore. If not, the survey must be remarked. A good survey is critical for proper line and grade.
9. Before operating, thoroughly inspect all equipment and repair equipment problems. Check hoses for cuts or bulges. Replace worn or damaged hoses.
10. Be sure the excavated launch and reception shafts are properly shored or braced to prevent slides or cave-ins.
11. Test air monitoring and ventilation detectors for proper operation. Never enter a tunnel without air monitoring and ventilation detectors.
12. A fully trained and qualified signal person must direct the excavator or crane operator when lifting and lowering equipment, pipe and supplies into the launch or reception shafts.
13. Never walk or work under any part of the excavator or crane and suspended loads.
14. Test each function and control to make sure they work properly.
15. Lock out electrical power at the source (generator) before servicing electrical components.
16. Do not make any modifications to any Akkerman products. Doing so could cause structural failure and will void the warranty.
17. Check shields and guards. All must be in place and undamaged.
18. Before starting equipment, thoroughly inspect all equipment. Inform all job site personnel that the equipment will be starting up. Do not start until all unauthorized personnel are clear of the equipment.
19. After start-up, observe all gauges, meters, controls and warning devices to assure they are functioning properly and their readings are within the operating range.

(continued on next page)

Operating Guidelines (continued)

20. Never leave the operator's station without first releasing hydraulic pressure, performing daily system shutdown, and disconnecting the main power supply.
21. Lockout/tagout the main disconnect, shut off generator or other external power source, and attach a DO NOT OPERATE tag or similar warning tag to the main power disconnect before performing maintenance.
22. Check line and grade alignment often. Keep in mind if you are off one degree, the bore will be off nearly two feet per one hundred feet.
23. Keep hands, body, and objects clear of rotating conveyor or operating auger. Do not operate without covers and guards in place. Lockout power before servicing.
24. If this manual becomes lost, contact your Akkerman Aftermarket Support representative for a new manual or download this manual from the Akkerman web site at www.akkerman.com.
25. The operator must note and report any slow down of machine operating time that might be an early warning of future problems.
26. Do not make adjustments or repairs to any of the system components while in operation. All pressure must be released and electrical power must be in lock out, tag out before adjustments or repairs.
27. High pressure hydraulics are used on the jacking system. Be sure all cover and guards are in place before operating.
28. Pressure peaks cause hoses to jump without notice. Keep all personnel away from hoses during operation of equipment.
29. Check laser beam often to avoid mis-alignment. Keep boring head well ventilated to achieve a consistent temperature throughout the pipeline since changes in temperature inside the pipe can cause laser beam to stray off target.
30. BEFORE operating conveyor, the chain from the conveyor safety valve MUST be tethered to conveyor AND ALL FOUR safety chains MUST be secured to conveyor.
31. Conveyor must not be started until all personnel have been moved away from the conveyor and have been warned that the conveyor is about to start up.
32. Before operating conveyor, all guards and/or safety devices must be in place and operable to prevent any contact with conveyor.
33. The area around conveyor loading and unloading points must be kept clear of obstructions during conveyor operation.
34. Conveyor must be stopped and the power source in lockout/tagout before performing maintenance, repair, or servicing.
35. The conveyor must be in placed in lockout/tagout before attempting to remove a jam or overload.
36. Wear reasonably close fitting clothing and remove jewelry to prevent an entanglement hazard.
37. While cutterhead and conveyor are operating, the operator must remain seated in normal operating position.
38. Check to be sure the bearing and lubrication pump, seal grease pump and scavenging pump are operating during the drive.
39. During TBM advancement, do not allow steering cylinder pressures to exceed 5,000 psi. Doing so will cause hydraulic component & structural damage.

SYSTEM OVERVIEW

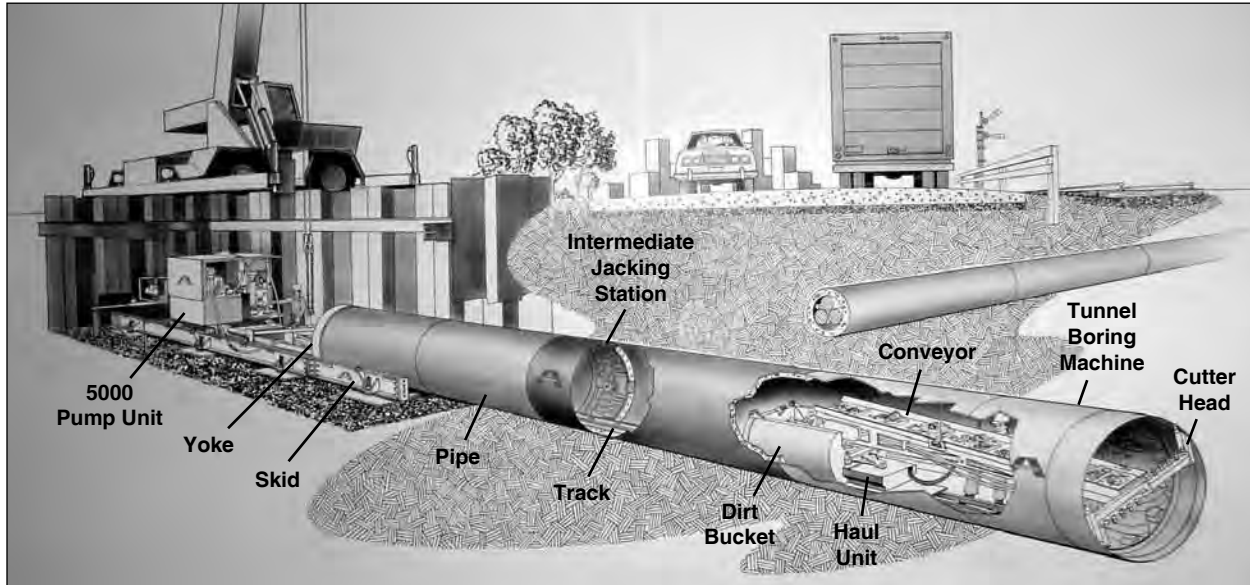

Tunnel Boring Machine (TBM)

The purpose of the TBM (boring head) is to excavate material at the cutter face and guide (steer) the pipe through the ground. As the TBM is advanced by the pipe jacking system, powerful hydraulic motors in the TBM rotate an inner drum. A cutter head or closed face attachment is connected to the drum. As it rotates, the attachment teeth excavate the face and the spoils fall into the drum. Dirt scoops and paddles in the drum dump the spoils onto a conveyor for removal from the pipe line.

Akkerman TBMs are articulated and hydraulically steerable in any direction. With the proper use of a laser, the strictest line and grade requirements can be maintained throughout the pipeline installation. An operator is positioned near the front of the machine to observe soil conditions and to monitor line and grade. A methane detection system is also standard equipment in Akkerman boring machines.

Pipe Jacking System

The pipe jacking system (pump unit, yoke and skid or jacking frame and optional intermediate jacking station) provide the horizontal thrust to push the TBM and pipe through the ground.

The *5000 Series II Pump Unit* high pressure system supplies hydraulic oil for the two main jacking cylinders and all intermediate jacking stations. The low pressure system supplies oil via hydraulic lines for the boring head and conveyor.

The *Yoke* is the frame that the main cylinders push against to advance the boring head and pipe. It is placed between the main thrust cylinders and the pipe, providing 360 degree surface contact against the pipe to minimize point pressure and reduce the chance of breakage. The yoke also acts as a dirt bucket unloading bay for the haul system.

The *Skid* base is the foundation of the 5000 Series II pump unit and yoke. It also acts as a guide for launching the boring head and pipe into the ground and transfers the main cylinder thrust rearward to the reaction block. Sectional skid base pieces are joined together for longer pipe joint lengths.

The *Intermediate Jacking Stations* are used to distribute the jacking forces throughout the pipe string. Each station consists of ram segments. Each 60-ton capacity segment has 5 rams (7 inch stroke). All stations are supplied oil by one set of lines from the pump unit and operated from one point within the jacking shaft.

Conveyor

As the spoils are dropped onto the conveyor from the TBM inner drum, the conveyor carries the material to the dirt bucket on the haul unit. The conveyor transports the spoil from the front of the boring head to the dirt bucket on the haul unit. Conveyors are offered in several sizes to maximize the performance for each size boring head. A screw conveyor performs better in certain sticky or sloppy ground conditions.

Haul Unit System

The haul unit transports the spoils from the tunnel boring machine back to the launch shaft. A crane is then used to hoist the dirt bucket out of the shaft for unloading. The typical haul unit system is comprised of a haul unit, track, and dirt bucket.

TYPICAL 5000 PIPE JACKING SYSTEM LAYOUT

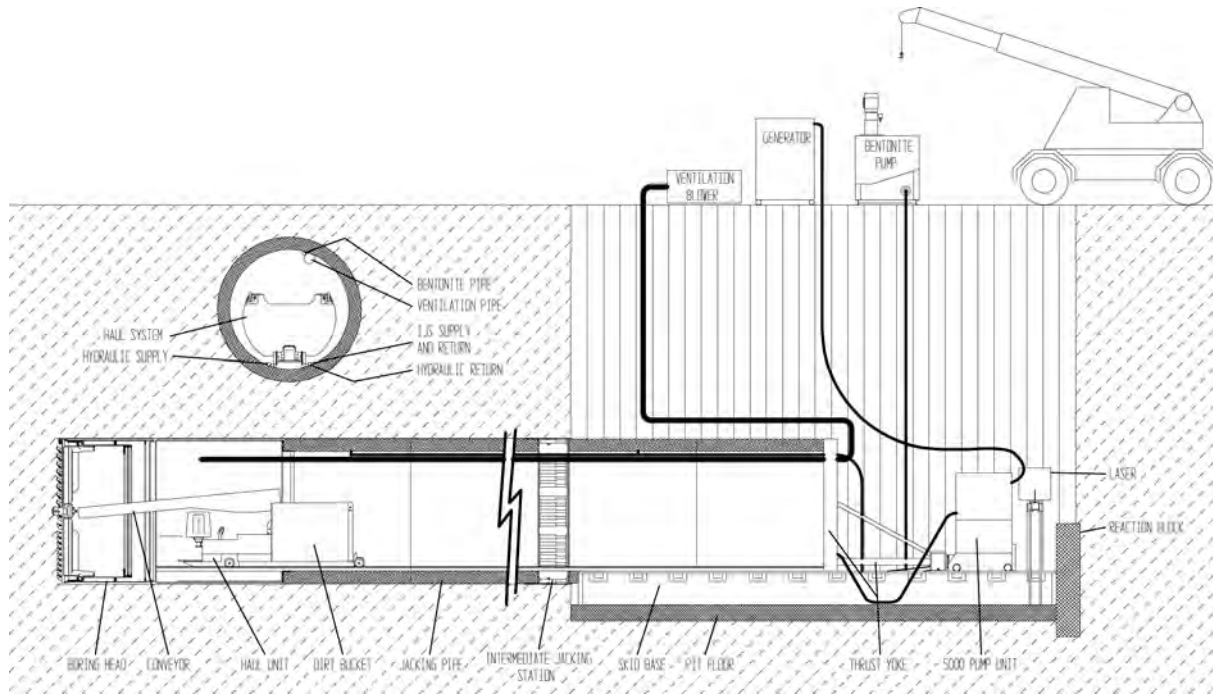

CUTTER HEADS

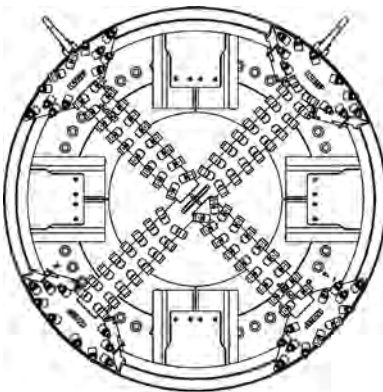

Carbide Quad Bar Head

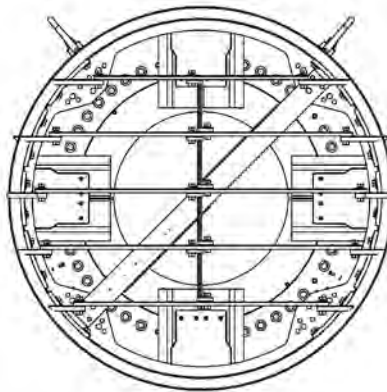

Sand Shelves

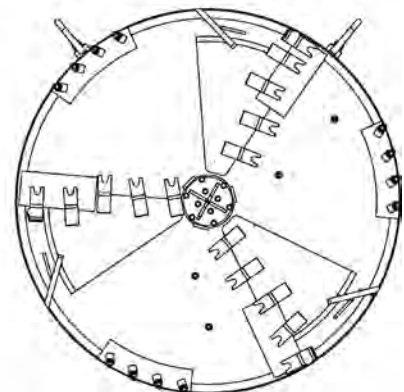

Optional Closed Face

The Tunnel Boring Machines are equipped with two cutter heads and may be interchanged underground.

- Carbide Cutter Head (clay, silty sand, soft to medium hard rock)
- Sand Shelves (loose unstable soil, but not flowing). Refer to Sand Shelf Operation in this section.

A Closed Face Cutter Head is optional and used for boring in unstable ground conditions.

The hydraulically operated doors control subsidence of loose soil while excavating the ground.

RECOMMENDED TOOLS & EQUIPMENT

Below is a list of tools and equipment for most complex technical construction operations. Financial resources and equipment availability are as much of a deciding factor as immediate job site requirements in determining what items should be on hand. This list contains many items, some of which may only be needed in special situations.

1. Safety equipment, first-aid kit, fire extinguishers, and stokes-type stretcher.
2. Any other required safety gear, such as air monitoring and gas detection systems, including personal gas detectors.
3. Ventilation fan(s) and ducting.
4. Communications equipment and good quality flashlights.
5. Generator sized for the project's power requirements including an adequate fuel supply for the generator's minimum period of operation.
6. A crane sized to project requirements.
7. Adequate pumping capacity for launch and reception shaft sump, and process water overflow, potential storm event inflow, trash pump, and hoses.
8. Adequate job site lighting, crew safety vests, and traffic control devices/signage, and barricades.
9. Wash down hose and spray nozzle.
10. Measuring and surveying equipment; including sight level or theodolite, laser levels, plumb-bobs, string lines and 100' tape measure.
11. Secure tool and equipment storage.
12. Rubber-tired front-end loader with bucket and forks.
13. Skid steer loader.
14. Shovels, rakes, and brooms.
15. Bullfloat and trowels.
16. Concrete bucket, tremie hose and hopper.
17. Carpentry tools including circular saw, sawzall, extension cords, and cordless drill w/bits, and basic hand tools.
18. Hammer drill and masonry bits, small "rivet buster" type jackhammer, chisels.
19. Sledgehammer(s), pry and crowbars of all sizes, spud wrenches, and pick-bars.
20. Various sizes hydraulic bottle jack(s), railroad or house type jacks, portapower hydraulic jack cylinder kit.
21. Log chains, shackles and clevis'.
22. Chain or cable-type "come alongs."
23. Arc welder and cutting torch rigs, eye shields and required protective gear.
24. Disc and mini-disc grinders, and extra discs.
25. Mechanic's tools, including but not limited to; wrenches, sockets, allen wrenches, torque wrenches, pliers, screwdrivers, hammers, etc.
26. Grease gun.
27. Electrician's tools, including test meters, voltage indicator, ground fault indicator, and specialty hand tools.
28. Pipe wrenches, water pump pliers, pump packing removal kit.

SITE PLANNING

It is important to carefully review the site and make sure that it is arranged in the most effective manner possible. Here is a list of equipment and site considerations that are typically needed for a TBM project.

Equipment:

- | | | |
|--------------------------|-----------------------------|-------------------------|
| - TBM | - Crane | - Pipe Lubrication Pump |
| - Pump Unit | - Portable Welders | - Spoil Removal Truck |
| - Skid and Jacking Frame | - Small Generator | - Portable Toilet |
| - Yoke | - Generator Or Power Source | - Fork Lift |

Other site considerations:

- | | | |
|--|-------------------------|-------------------------------|
| - Spoil Removal Truck Access | - Pipe Unloading area | - Fresh Water Supply |
| - Launch Shaft Size | - Hose Interconnections | - Electrical Interconnections |
| - Walkways | - Pipe Staging Area | - Jacking Shaft Access Area |
| - Any Traffic or Other Physical Restraints | | |

SITE PREPARATION

1. The contractor is fully responsible for the design and construction of the OSHA required launch and reception shafts. For setup and installation drawings specific to the project, pipe size and shoring type, contact the Akkerman Sales Department.

⚠ WARNING Gases may be present during excavation and could cause severe personal injury or death. Use an approved air analyzer to detect hazardous gases on the job site and in the tunnel at all times.

2. After the soil analysis, shaft layout design, and survey are complete, excavate the launch and reception shafts. Be sure the shafts will be well drained and use proper shoring or bracing in accordance with your local, state, and federal regulations.

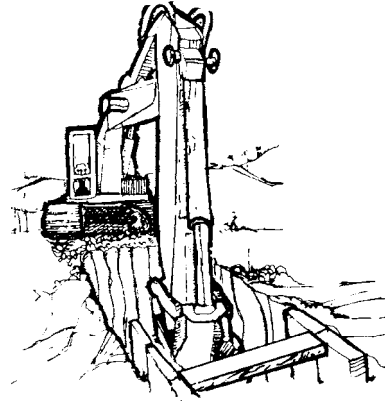

AEM is the original author and publisher of the above illustration

3. Construct a shaft floor with a solid base suitable for the weight of the skid, yoke, pump unit, jacking frame, TBM system and pipe. Consult your civil and structural engineers for your shaft floor requirements.
4. Place steel plates on the jacking shaft floor for supporting the base of the skid (rails), jacking frame, TBM, and pipe.



5. Construct a concrete thrust block designed to withstand the applied load. A structural engineer must be consulted on the design of this block. This block must be square with the line of the tunnel axis and skid assembly.

NOTICE If using a jacking frame, space must be provided for the mounting of the laser behind the jacking frame.

6. Proceed to Setting Up The Jacking System in this section.

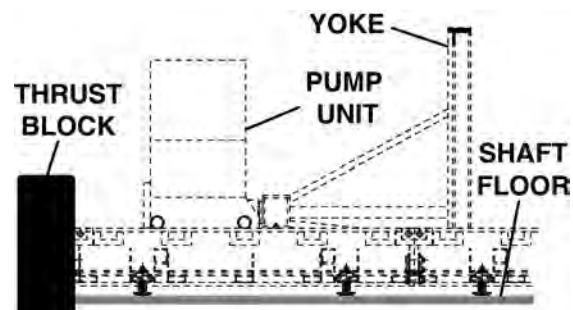

Set Up With 5000 Series II Pump Unit

SETTING UP THE JACKING SYSTEM

⚠ WARNING Suspended loads may fall and cause severe injury or death. Do not allow anyone to enter area under or around a suspended load.

NOTICE Be sure the crane or excavator and all lifting equipment is rated to lift load. Remember, you may be able to lift the load in close at ground level, but as the load radius and elevation change, the lifting capacity of the crane or excavator or other lifting equipment decreases.



1. Lower skid assembly into launch shaft using lift eye assemblies (A) and place against the thrust block. Correct the skid assembly line and grade with leveling screws (see inset). Typically there should be at least 6 inches between the front of the jacking rails and the shaft wall to allow room for the cutterhead of the TBM.

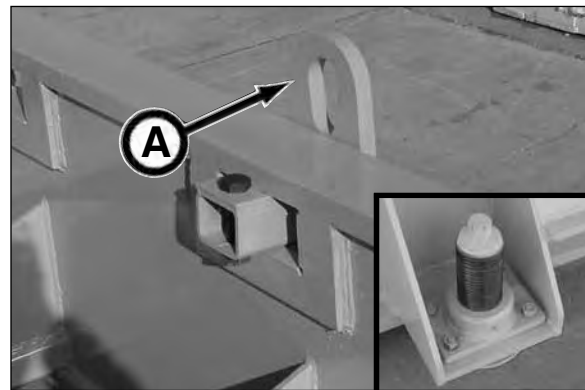

If necessary, lower other skid assembly(s) into launch shaft and mount to first skid assembly as follows:

- a. Align the skid sections using the locator pin (B).

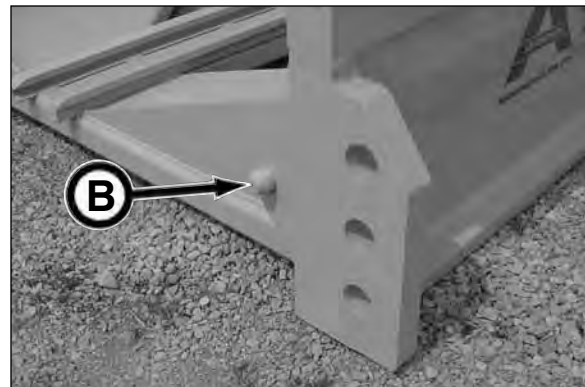

- b. When skid assemblies are properly aligned, mount with six 2 in. bolts and nuts.



(continued on next page)

c. To complete mounting, install skid split bars (A) into side skid base assembly making sure the holes of the bar line up with the holes (B) in the skid assembly. Insert skid split pins (C) with slot of pin at the 12 o'clock position for set screw. Secure skid split pin with set screws (D).

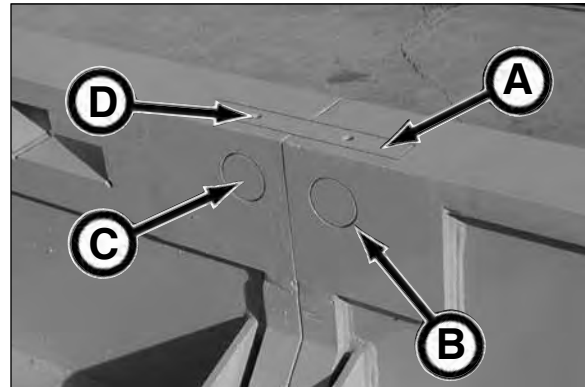

d. Continue mounting other skid sections, if required.

e. Check to be sure that the skid assembly is making full contact against thrust block.

NOTICE

Both the left and right ends of the skid frame **MUST** be against thrust block, otherwise damage will occur to the skid frame during jacking operation.

f. Once skid assemblies are properly joined, check for the proper line of the project bore. Adjust skid (s) as needed.

g. Once skid assemblies are in the proper line, correct the skid assembly grade with leveling screws (E). Due to the weight of the skid assemblies, place a hydraulic jack below the jack pad (F) to raise or lower skid as needed for ease of adjusting grade with leveling screws.

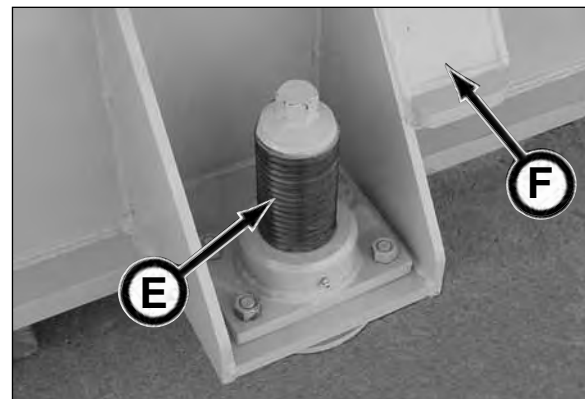

h. When completed, recheck line and grade and adjust as needed.

2. Lower the pump unit onto skid assembly. Check to be sure the drive wheels are resting on the skid assembly top rails.

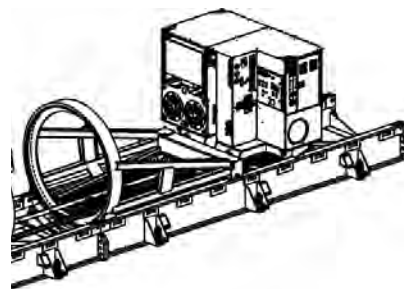

3. (Yoke, if equipped) Lower the yoke (in front of the pump unit) onto the lower skid assembly rails (G), while making sure the yoke wheels are resting on the top skid assembly rails (H).

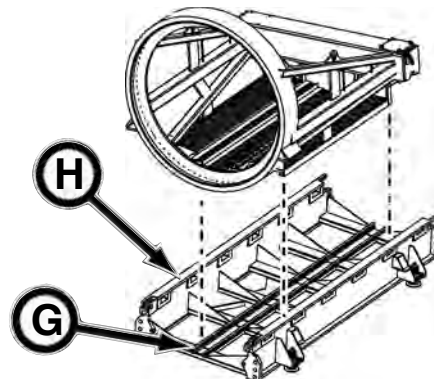

(continued on next page)

4. (If equipped with jacking frame) Recheck line and grade of skid assembly rails. Lower jacking frame onto skid assembly rails and make sure the frame is properly centered on the rails.
6. Proceed to Setting Up The Tunnel Boring Machine in this section.

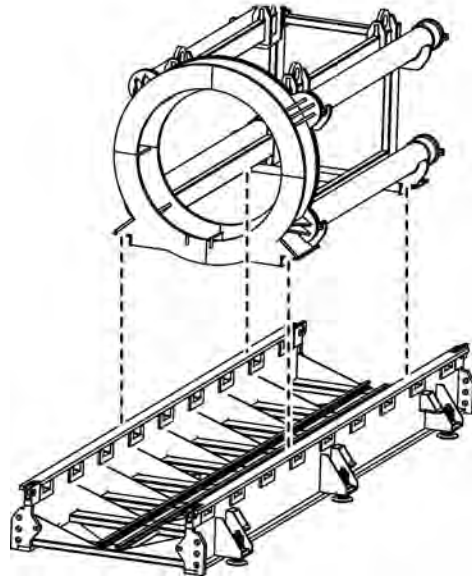

SETTING UP THE TUNNEL BORING MACHINE

1. Lower tunnel boring machine (TBM) onto the front of the skid assembly, making sure the cutter teeth on the TBM will not strike the skid assembly when the cutterhead is rotated.



- 2a. (48SC, 420, 480, & 540) Check TBM side to side level by placing level on the top of unloading compensator block (A). If not level, have crane operator move the TBM until TBM side to side is level.

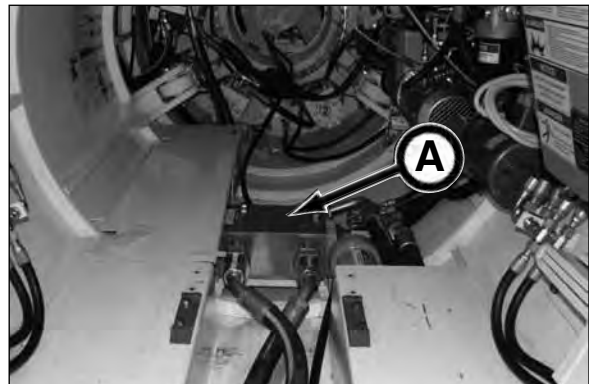

- 2b. (600, 660, 720 & 780) Check TBM side to side level by placing level (B) on the cylinder lift trolley rail. If not level, have crane operator move the TBM until TBM side to side is level.

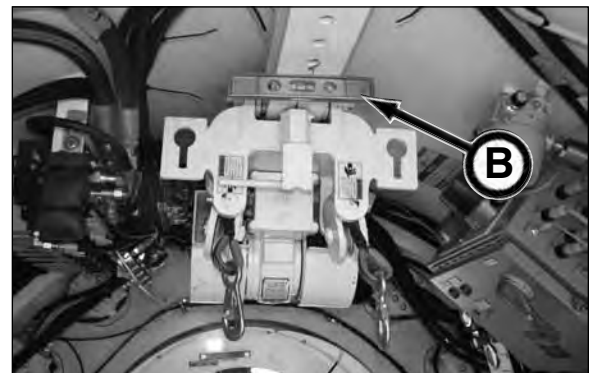

(continued on next page)

- 3a. (48SC, 420, 480, & 540) Place level on inner drum level bar (A - dirt/carbide level bar; B - closed face level bar) and rotate the inner drum as needed until level. This will position the target bolt (C) on the cutter bar in the proper location for setting the guidance system.

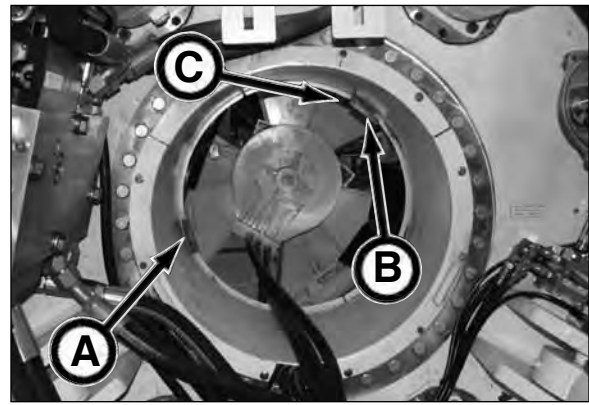

420 Series II

- 3b. (600, 660, 720, & 780) Place level (D) on inner drum level bar and rotate the inner drum as needed until level. This will position the target bolt (E) on the cutter bar in the proper location for setting the guidance system.

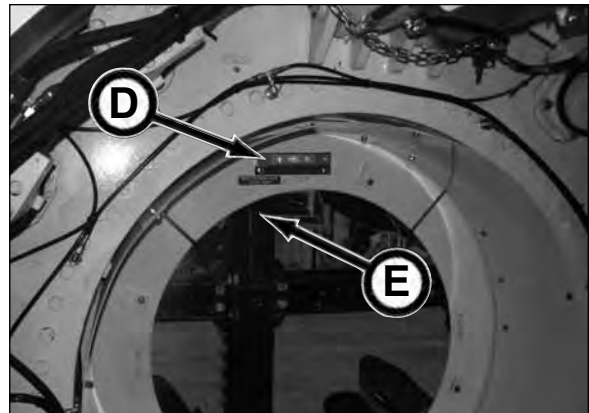

600 Series II

4. Check to be sure front drum is parallel with mid drum/dirt wing drum. Place a 4' level or other long straight edge between the front drum and mid drum sections (as shown). If mid section lines up with level or straight edge, then the front and back sections of the TBM are running parallel.

If there is a gap between the two sections, the sections are not parallel. Move steering cylinders as needed until there is no longer a gap.



NOTICE The TBM line and grade **MUST** be steered parallel to the jacking system base.

5. Recheck jacking system base grade and alignment. Check machine elevation and make final pipe line calculations, allowing for cutter bit "over cut."
6. Lower the stand for the laser guidance system as close to the rear of the jacking shaft as possible without contacting skid assembly, jacking frame, pump unit or thrust block. Be sure the guidance system will not be affected by thrust applied to jacking system.



(continued on next page)

7. Place the generator or main power source as far away from the launch shaft as possible. This will reduce the noise to the operator and make it easier to communicate with the launch and reception shaft personnel.



⚠ WARNING NEVER operate tunneling equipment without proper operating gas detection systems. Severe personal injury or death can occur without proper gas detection systems in place due to accumulation of combustible and toxic gases, and depletion of oxygen.

If the gas levels exceed MSHA/OSHA prescribed levels, leave tunnel immediately! Do not activate or deactivate any electrical or hydraulic devices, since any sparks could cause an explosion.

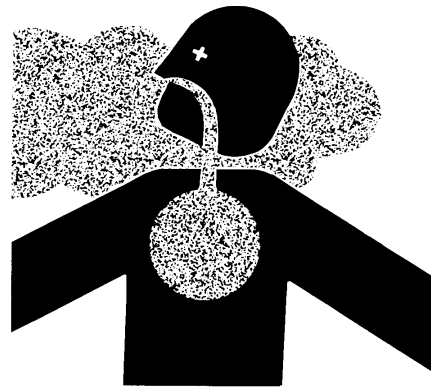

8. Connect the electrical power cable connections from the generator or power source to the Pump Unit. Refer to Preparing Pump Unit For Operation and Setting Up The 5000 Pump Unit - Start-Up Check in the Operation section of your 5000 Series II Jacking System Operator's Manual.



⚠ WARNING PINCH POINTS! Watch your fingers, hands, and legs while equipment is in operation.



(continued on next page)

⚠ CAUTION Pressure peaks cause hoses to jump without notice. Keep all personnel away from hoses during operation of equipment.



⚠ WARNING Conveyor is heavy and could drop while installing or operating, resulting in severe personal injury or death. Conveyor must be fastened securely to supports while moving conveyor into position. Once conveyor is in position, lifting cables and ALL FOUR conveyor safety chains MUST be secured to conveyor.

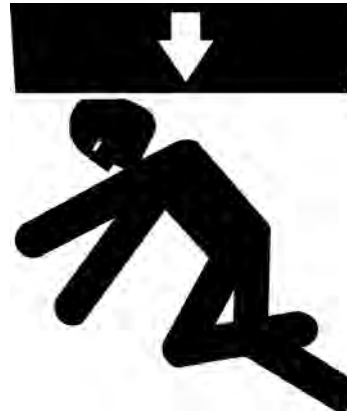

9. Carefully install conveyor into the TBM and connect the lifting cables to the front lifting position on the conveyor lifting eyes.



10. Lift the conveyor with the conveyor lift and slip bearing at the front of the conveyor onto the pin at the center of the cutter bar or closed face attachment.



(continued on next page)

11. Connect the four safety chains to the conveyor and lower the conveyor lift just enough to provide adequate slack in the lift cables to move the lifting hooks to the rear (operating) position on the conveyor lifting eye.

⚠ WARNING Conveyor can jam in rotating cutterhead causing conveyor to swing into operator, resulting in severe personal injury.

1. The conveyor safety valve MUST be tethered to conveyor and the operation MUST be tested before starting the conveyor to insure proper operation.
2. ALL FOUR safety chains MUST be secured to conveyor.
3. Operator MUST remain seated in normal operating position.

12. Fasten chain (A) from conveyor safety valve (B) to conveyor hook (C).

13. Connect conveyor supply and return hydraulic hoses (D) to TBM quick disconnects.

14. If not already set up, set up the 5000 Series II Pump Unit. This must be completed before setting up pump unit and TBM hydraulics. Refer to Setting Up The 5000 Pump Unit - Start-Up Check in Section 6, Operation of your 5000 Series II Jacking System Operator's Manual.

15. Once pump unit is properly set up, proceed to Pump Unit & TBM Hydraulic Setup - Single & Dual Feed in this section.

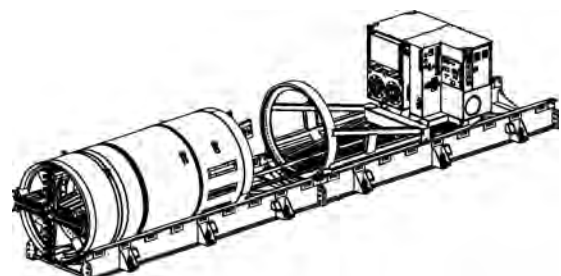
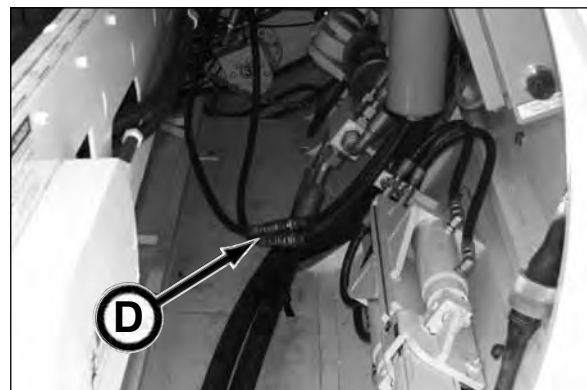
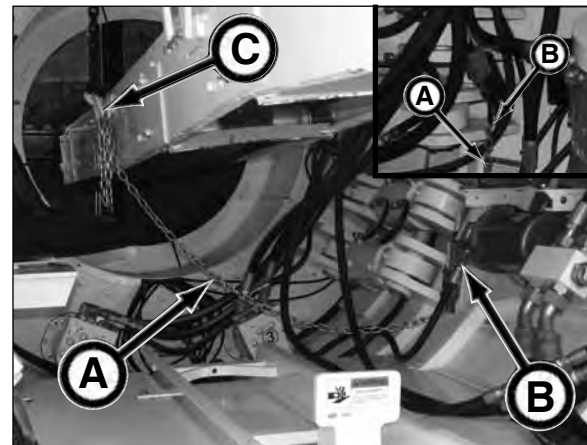
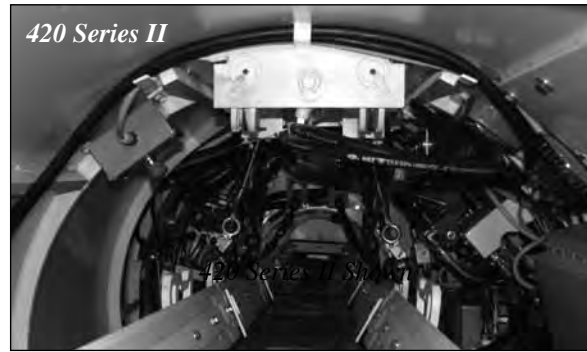

PUMP UNIT & TBM HYDRAULIC SETUP - SINGLE & DUAL FEED

There are two hydraulic supply/return options available for setting up the 5000 Series II Pump Unit with the tunnel boring machine; single feed supply and dual feed supply.

The single feed option supplies 60 gpm of low pressure oil to the boring head, steering, and conveyor.

The dual feed option supplies up to an additional 60 gpm of low pressure oil (total of 120 gpm, though 420 Series II maximum is 90 GPM) with the use of the auxiliary supply motor. Typically the main boring head supply will run the boring head, and steering of the TBM, and the auxiliary supply primarily powers for the conveyor unit. Though the auxiliary supply can power the conveyor and provide additional power to the boring head.

⚠ WARNING Escaping oil or other fluids under pressure can penetrate your skin causing serious injury. Contact medical help immediately if any oil or fluid is injected into your skin. Before hooking up the supply hoses to the pump unit for the first time on each drive, refer to “BEFORE INITIAL SUPPLY HOSE HOOKUP ON EACH DRIVE” below.

BEFORE INITIAL SUPPLY HOSE HOOKUP ON EACH DRIVE:

On the 5000 Series II Pump Unit, move controls to the OFF or neutral position, release boring head and auxiliary supply hose pressure with boring head supply bleed off valve (A) and auxiliary supply bleed off valve (B), AND use gloves before connecting or disconnecting hydraulic oil hoses/lines.

IMPORTANT: If switching from single feed to dual feed during drive, the hydraulic pressure MUST be released BEFORE connecting/disconnecting hoses using the supply bleed off valves.

Single Feed (60 GPM Maximum - Low Pressure)

1. Connect pump unit main supply quick coupler hose (C) to the TBM supply quick coupler hose (D). Cap pump unit auxiliary supply quick coupler hose (E) and TBM supply quick coupler hose (F) for single feed option.
2. Connect pump unit return line quick coupler hose (G) to the TBM return line quick coupler hose (H). Cap pump unit return line quick coupler hose (I) and TBM return line quick coupler hose (J).

NOTICE

Though it is possible for a 90 GPM flow through the main supply line, it is highly NOT recommended to do so since it will cause additional heat and pressure loss due to back pressure in the system. It is recommended to use a maximum of 60 GPM flow through each of the boring head and auxiliary supply lines for a max. flow of 120 GPM. The maximum flow for the 420 Series II is 90 GPM

Dual Feed (90 GPM Maximum - Low Pressure)

1. Connect pump unit main supply quick coupler hose (C) to the TBM supply quick coupler hose (D).
2. Connect pump unit auxiliary supply quick coupler hose (E) to the TBM auxiliary supply quick coupler hose (F).
3. Connect pump unit return line quick coupler hoses (G and I) to the TBM return line quick coupler hoses (H and J).

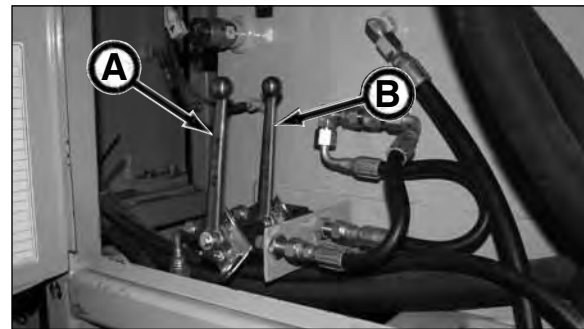

5000 Series II Pump Unit

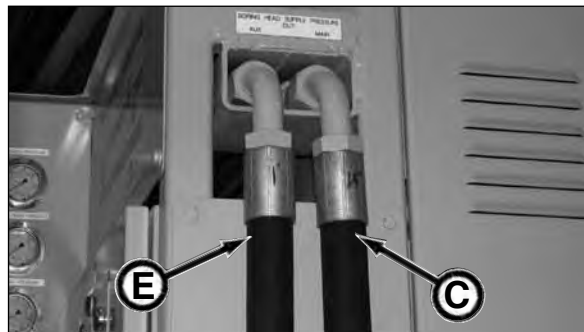

5000 Series II Pump Unit

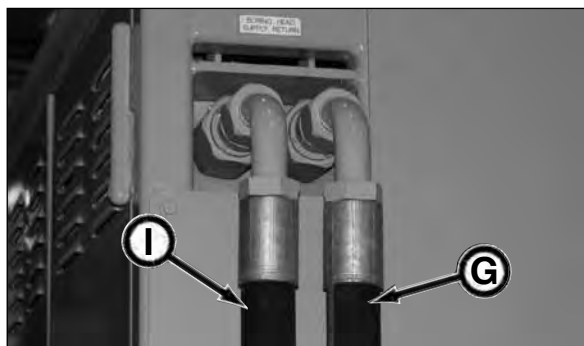

5000 Series II Pump Unit

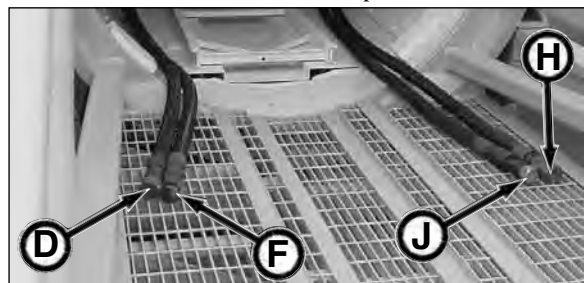

TBM Supply & Return Hoses

CHECKOUT EQUIPMENT PRIOR TO START-UP

1. Perform equipment maintenance as shown in Periodic Maintenance section.
2. Connect clean water supply hoses with 20 GPM minimum to heat exchanger in pump unit.

NOTICE If pumping 80+°F water, flow should be around 25 GPM.

3. Check the oil level in the pump unit hydraulic reservoir. Add oil if necessary.
4. Inspect conveyor lift cables daily and replace immediately at the first sign of wear or damage.
5. Check to be sure all suction valves are open and tie strapped to prevent accidental closing of valves.
6. Inspect all hoses and electrical lines for damage. Replace before operating.
7. Be sure all hydraulic hoses and electrical lines are properly installed.
8. Refer to your haul unit, gas detection system, pump unit, and jacking frame operation manuals for pre-start checks.
9. Be sure to check the operation of ALL E-Stop buttons before operating TBM.



USING EMERGENCY STOP

WARNING ALL Emergency Stop buttons MUST be operating properly BEFORE operating Pump Unit and TBM. Failure to do so may cause severe injury or death.

E-Stop on 5000 Series II Pump Unit

Push 5000 Series II Pump Unit Emergency Stop button (A) IN to stop all electrical and hydraulic functions on the 5000 Series II Pump Unit and the Series II TBM.

The E-Stop button will illuminate when it is pulled OUT.

The E-Stop button must be pulled out to restart operation.

NOTICE All E-Stop buttons (Pump Unit E-Stop (A), Remote Pump Unit E-Stop (B) and TBM E-Stop (C) [if equipped]) MUST be pulled out to restart operation.

The operating lights will not be functional.

E-Stop on Series II TBMs

Push Series II Emergency Stop button (C) IN to stop all electrical power in the TBM. The hydraulic functions will continue to operate until the hydraulic controls are shut down in the pump unit.

IMPORTANT: DO NOT operate the Series II TBM without electric power. Below is the result of no electric power in the TBM:

1. The bearing oil pump will not operate therefore the bearing cavity oil will not be recirculated.
2. The gas detector is no longer functional.
3. The scavenging pump will not operate causing the excess oil in the scavenging pump reservoir to flow out of the circuit breather into the TBM.
4. The TBM operating lights will not function.
5. The bearing seal grease pump will not operate, as a result, the bearing seals will not be greased.

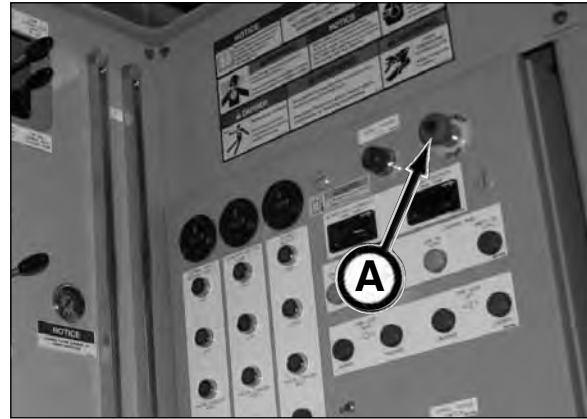

E-Stop on 5000 Series II Pump Unit

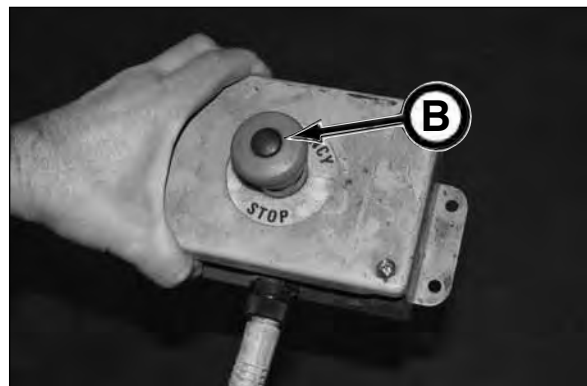

Remote E-Stop on 5000 Series II Pump Unit



E-Stop on Series II TBM

TBM START-UP PROCEDURE

1. The 5000 Series II Pump Unit start-up check must be performed prior to TBM start-up. Refer to Setting Up The 5000 Pump Unit - Start-Up Check in section 6 of your 5000 Series II Jacking System Operator's Manual.

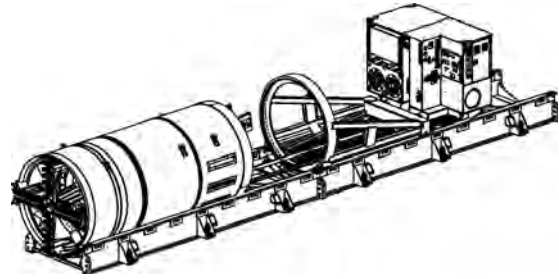

2. With power in lockout/tagout, connect the TBM hydraulic hoses to the power unit. Refer to Setting Up TBM in this section.



3. Flip the TBM main power switch (A) to the OFF position.



⚠ DANGER Be sure the 5000 Series II Pump Unit E-Stop button is pressed IN to prevent any accidental startup. Failure to do so will cause severe injury or death.

4. Install 480 V power cable to Incoming Power electrical connection (B) on TBM electrical box.

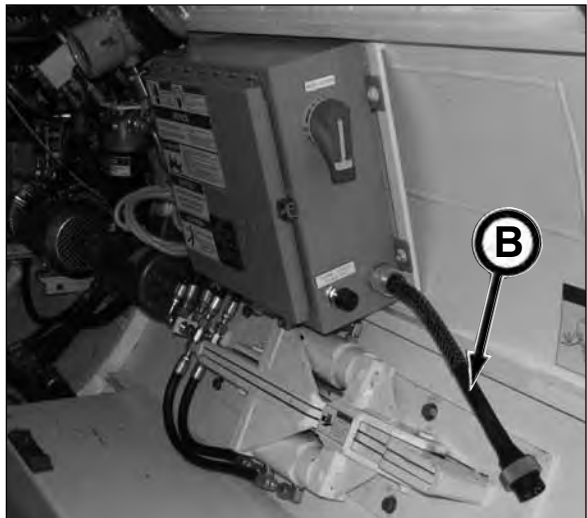

(continued on next page)

5. Move all control valve handles to the neutral or OFF position on the 5000 Pump Unit and the TBM.

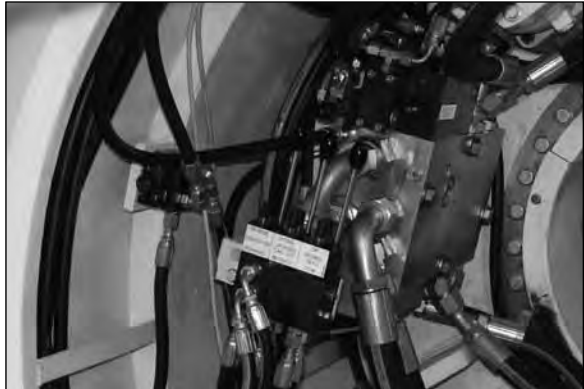
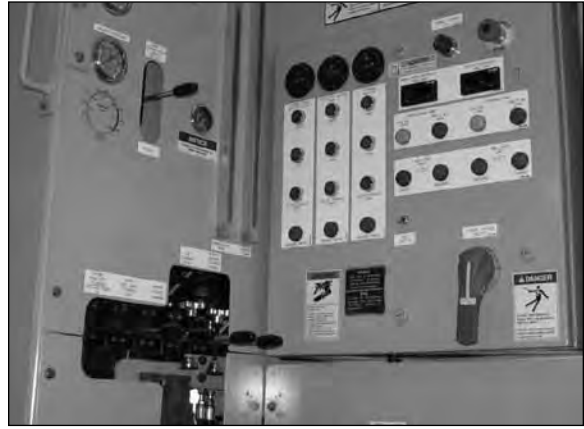

6. Turn on external power source and pump unit.
7. Pull out all E-Stop buttons, (A) and check each for proper operation. Check to be sure phase power is correct. For more information, refer to Setting Up The 5000 Pump Unit - Start-Up Check in section 6 of your 5000 Series II Jacking System Operator's Manual.

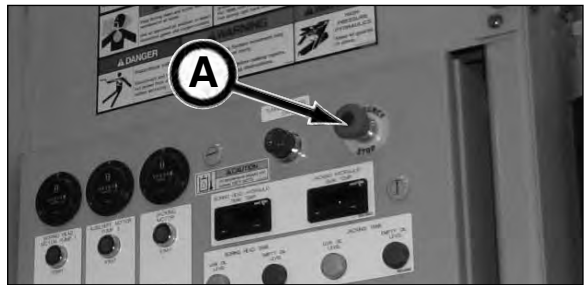

E-Stop on 5000 Series II Pump Unit



Remote E-Stop on 5000 Series II Pump Unit



E-Stop on Series II TBM

8. Check the Tunnel Power Phase OK light (A).

9. If the Tunnel Power Phase OK light is illuminated, turn on main power switch (B).

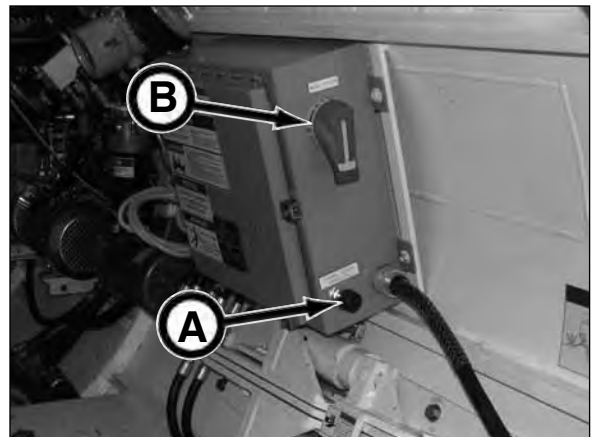

10. Check for illuminated 24 VDC Power On light (C). If light is not illuminated, a certified electrician must troubleshoot the problem.

11. Check gas detection system for proper operation and gas level. Refer to your Gas Detection System Operation manual for more information.



NOTICE If Conveyor Safety switch light (D) is illuminated, the cutter head will not rotate.

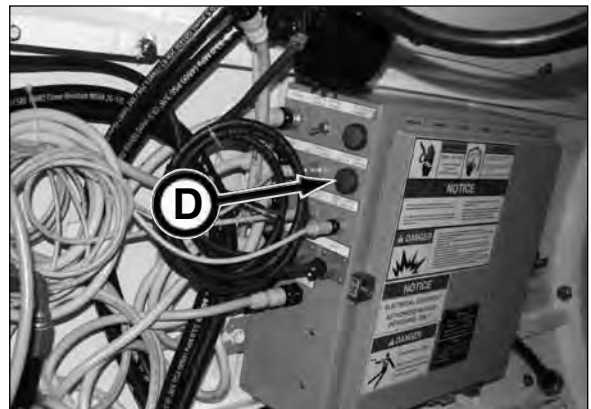

12. Be sure conveyor lift safety chains are connected to conveyor and chain from conveyor safety valve switch is fastened to conveyor hook.



13. Check both pressure filter indicators and bearing oil lube filter indicator. Replace if needed.
14. Check all hoses and fittings for leaks.
15. Be sure all guards are in place and securely fastened.

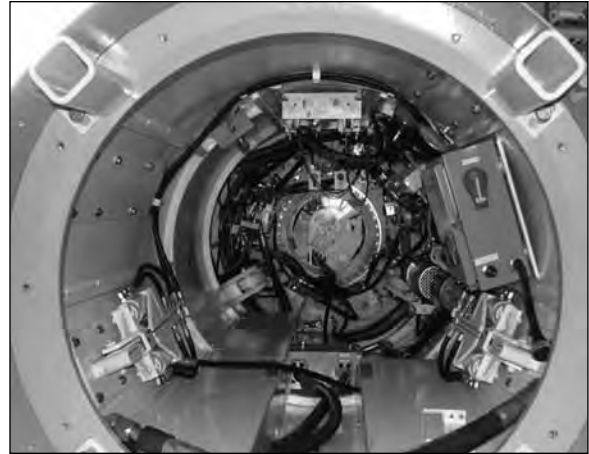

16. Using the steering controls (A,B,C), set the corresponding cylinders at the 50% cylinder extension position:

- 48SC, 420, 480, 540, 600: **2.0" (51 mm)**
- 660, 720, 780: **3.0" (76 mm)**

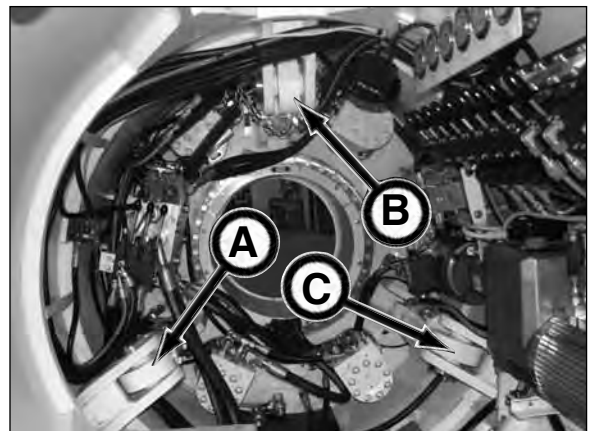
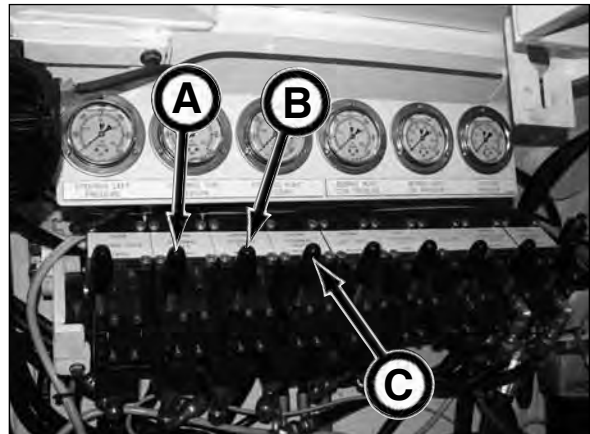

420 Series II

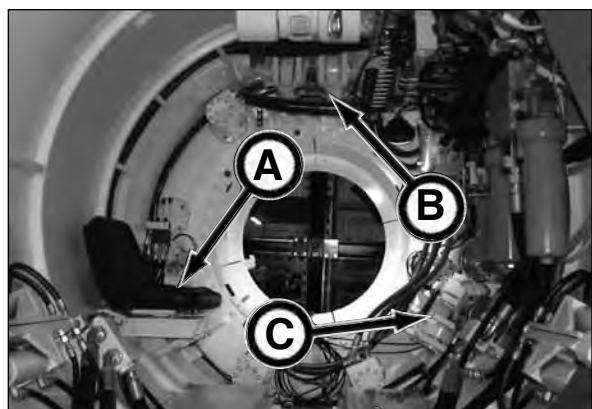

600 Series II

(continued on next page)

17. SLOWLY operate Conveyor Lift control (A) to determine the proper lift/lower movement speed.

⚠ WARNING Adjusting the lift speed too quickly for the operator to handle could cause severe injury or machine damage.



18. Operate the Boring Head Control (B) and adjust rotation speed as needed with lever.
19. Operate conveyor with Conveyor Control (C) and adjust speed as needed.

The further the lever is moved from neutral, the faster the conveyor belt or auger will move. This control also is equipped with a friction detent, so the lever will remain in the desired position until you move it back to neutral position.

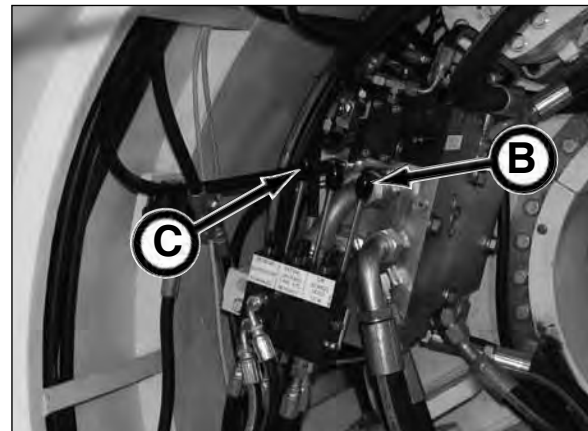

420 Series II

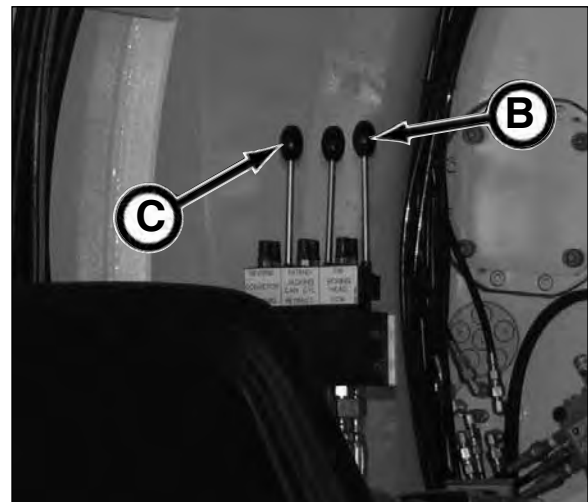

600 Series II

20. While operating TBM, periodically check to be sure the bearing oil lubrication pump (A), seal grease pump (B) and scavenging pump (C) are functioning properly.

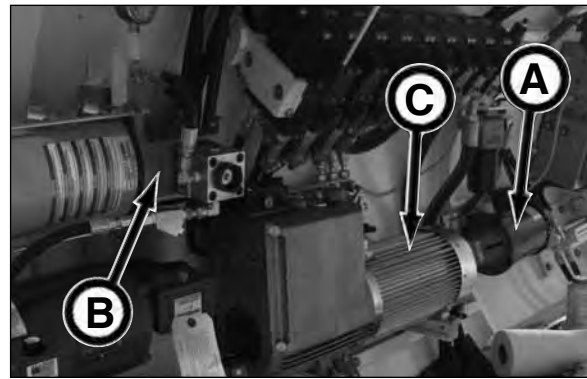

420 Series II

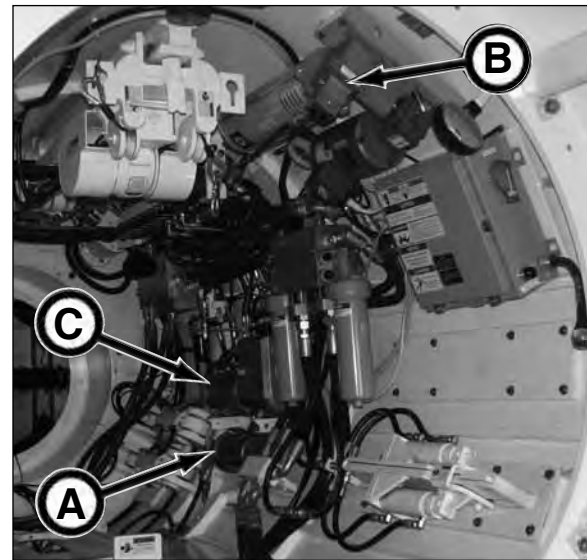

600 Series II

21. Check that the cutter bar or closed face mounting bolts are securely fastened.
22. Verify that the TBM operator is able to quickly evacuate the TBM in the event of an emergency.
23. Proceed to Launching The TBM in this section.



LAUNCHING THE TUNNEL BORING MACHINE

Refer to your 5000 Series II Jacking System Operator's Manual for proper operation during TBM launch.

NOTICE Perform TBM Start-Up Procedure BEFORE launching TBM.

WARNING Conveyor can jam in rotating cutterhead causing conveyor to swing into operator, resulting in severe personal injury. While cutterhead is rotating:

1. Operator MUST remain seated in normal operating position.
2. The conveyor safety valve (cutterhead drive dump valve) MUST be tethered to conveyor and the operation MUST be tested before starting the conveyor to insure proper operation.
3. ALL FOUR safety chains MUST be secured to conveyor.

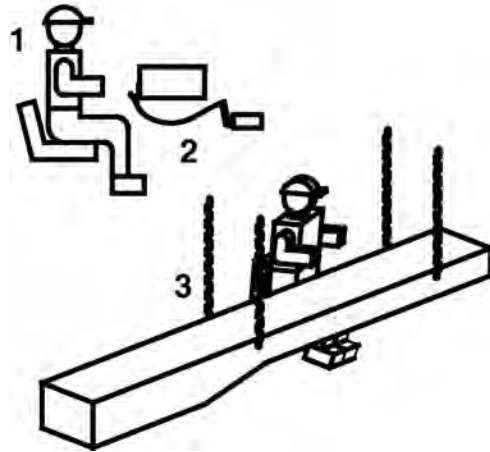

1. Move the conveyor to the operating position where spoils will fall into dirt bucket.



WARNING Avoid contact with conveyor. Failure to do so could cause severe injury or death.



(continued on next page)

NOTICE

NEVER operate equipment if it has been engulfed with water. Contact your Akkerman Aftermarket Support representative for proper procedures on how to restore equipment for operation.

2. Fully extend steering cylinders with the Steering Cylinder controls (A, B & C) and then retract approximately 2.0" (51 mm).

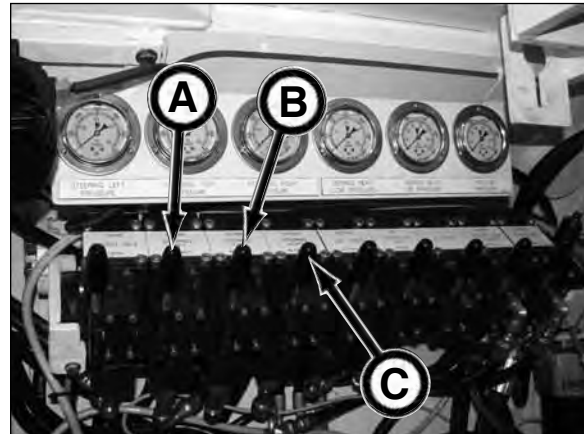

WARNING

Be sure that forward pull exists on the conveyor lifting cables and safety chains throughout the full advance travel. Failure to do so may cause severe injury from conveyor slipping out of the cutter bar center pin.

3. Return the conveyor to the maintenance position.



DANGER

Staring into laser light will cause severe injury. Do not stare into laser guidance system light beam. Avoid direct eye exposure.

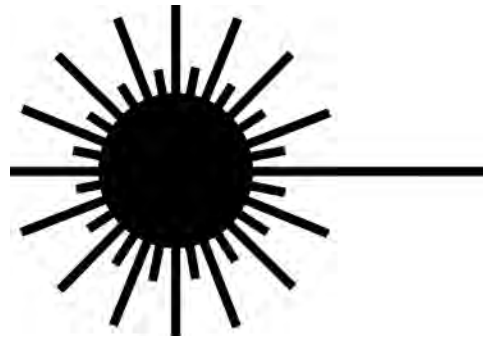

4. Set laser guidance system to grade and alignment, and be sure the laser beam has a clear path to the cutter bar target bolt.

NOTICE

For proper guidance system installation, refer to your laser manufacturer's installation requirements.

NOTICE

Typically after TBM is leveled and prior to launching the TBM, some operator's steer 1/2" to 3/4" (13 to 19 mm) up to compensate for the ground conditions at start up. The TBM has a tendency to dip once launched into the ground. This steering adjustment is dependent upon ground conditions.



(continued on next page)

5. Move the conveyor into the operating position.



6. Lower dirt bucket into position behind the conveyor. Do not install the haul unit at this time.



⚠ WARNING Conveyor can jam in rotating cutter head causing conveyor to swing into operator, resulting in severe personal injury. While cutter head is rotating:

1. Operator MUST remain seated in normal operating position.
2. The conveyor safety valve (cutterhead drive dump valve) MUST be tethered to conveyor and the operation MUST be tested before starting the conveyor to insure proper operation.
3. ALL FOUR safety chains MUST be secured to conveyor before operating inner drum.

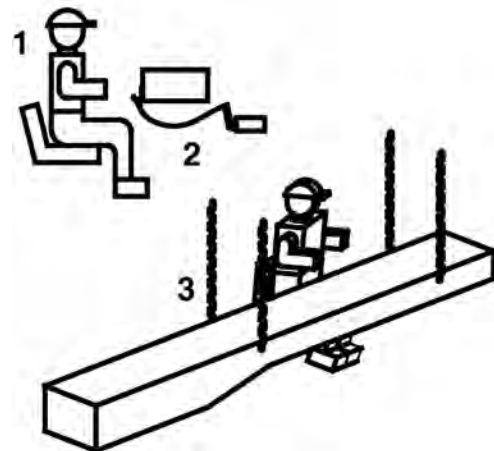

(continued on next page)

⚠ DANGER Contact with rotating auger conveyor or belt conveyor rollers will cause severe injury or death. Keep hands, body, and objects clear of operating auger and conveyor. Do not operate without covers and guards in place. Lockout power before servicing.



NOTICE Refer to Operating The Conveyor in this section for more information.

7. Operate the conveyor with control (A) to desired speed, rotate cutter head with boring head control (B) and apply forward thrust to the TBM from pump unit

NOTICE Before rotating the cutter head, be sure the cutter teeth will not interfere with jacking system frame.

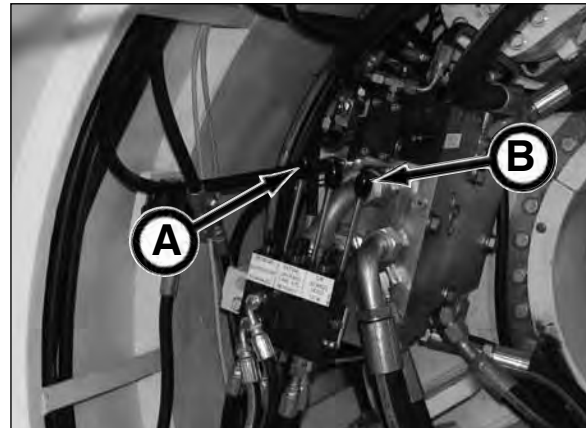

420 Series II Shown

NOTICE Remove lift eyes (hoist rings) after TBM is properly setup in launch shaft and retain for later use when removing TBM. Once lift eyes are removed, install a 3/4 UNC x 1 bolt to protect hole threads from dirt or debris during tunneling operation.



NOTICE Use push blocks (C) to push TBM forward so yoke does not damage outside ring of TBM. Remove push blocks before installing first pipe.

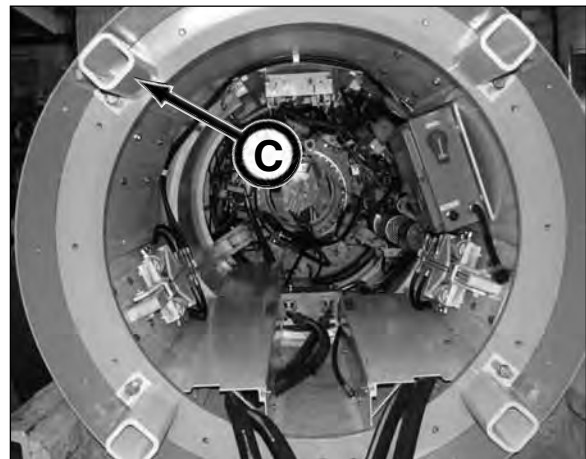

(continued on next page)

8. When the dirt bucket is full, flip the bucket lift eye up.



⚠ WARNING Suspended loads may fall and cause severe injury or death. Do not allow anyone to enter area under or around a suspended load.

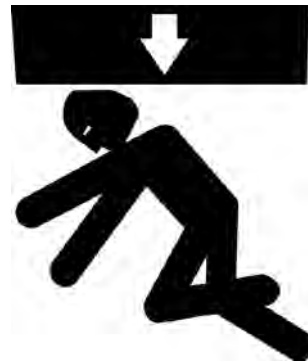

9. With a crane or excavator, check for clearances and carefully lift dirt bucket out of unloading area and move to dumping site.



10. Unload dirt bucket. The dirt bucket is self-dumping when using a two-line crane or when attaching a stationary line.



(continued on next page)

11. Check if TBM over cut is sufficient to allow steering corrections, but does not exceed job specifications.
12. Check and adjust grade and alignment often (after each dirt bucket at a minimum) to avoid misalignment and excessive jacking pressure. Refer to Making Steering Adjustments and Adjusting TBM Roll in this section.

NOTICE

While operating TBM, periodically check to be sure the bearing oil lubrication pump, seal grease pump and scavenging pump are functioning properly.

13. Continue operation until the TBM has been advanced forward enough to lower the trailing section of the TBM or the first pipe into place.
14. Shut down the TBM by moving the TBM Main Power switch and the Tunnel Power switch (on the pump unit) to the OFF position and stop the 5000 Series II boring head and auxiliary motors. Return all hydraulic controls to the OFF or neutral position.

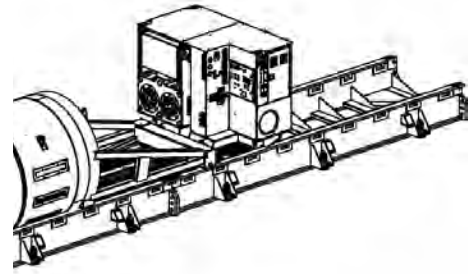

WARNING

Escaping oil or other fluids under pressure can penetrate your skin causing serious injury. Contact medical help immediately if any oil or fluid is injected into your skin. ALWAYS switch power supply switches to the STOP position, move all control valves to the OFF position AND use gloves before connecting or disconnecting hydraulic oil hoses/lines.



15. Disconnect and cap the TBM supply and return hoses.



(continued on next page)

⚠ DANGER

The Akkerman gas detection system only monitors methane gas levels. Monitoring of gas levels is the responsibility of the contractor. This includes accumulation of combustible and toxic gases, and depletion of oxygen. The contractor must keep the tunnel ventilated with fresh air AT ALL TIMES.

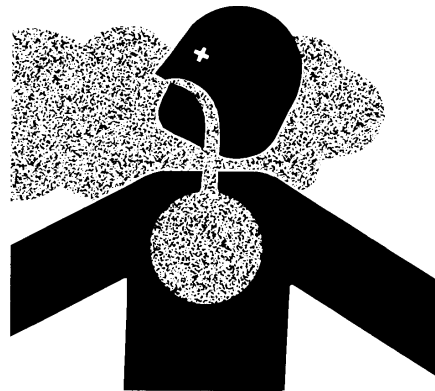

16. With the TBM Main Power switch AND the Tunnel Power switch in the OFF position, disconnect the ventilation, electrical and communication lines.
17. Retract the pump unit/yoke far enough to lower the first pipe on the jacking system base (skid).



⚠ WARNING

Suspended loads may fall and cause severe injury or death. Do not allow anyone to enter area under or around a suspended load.



18. Stop the 5000 Series II Pump Unit boring head and auxiliary motors and lower the first pipe onto the jacking system base.



(continued on next page)

19. Start the jacking system and apply forward thrust until the first pipe mates with the TBM.



20. When the first pipe has been set, install the first haul system track (A) and secure to TBM. Refer to Installing Track in the Operation section of your Haul Unit Operator's Manual for track installation.

NOTICE

Be sure there is always track connecting the pipeline to the rear of the jacking frame/yoke for the haul unit and the loading and unloading of the dirt bucket.

21. Reconnect the TBM supply hoses (B) and return hoses (C) (adding hoses as needed), ventilation supply line, power cables and communication lines. Alert everyone in tunnel and launch shaft areas that the power will be turned on. Once it is safe, depress the TBM boring head and auxiliary (if used) motors to the START position. Move the Tunnel Power switch (pump unit) and the Main Power switch (TBM) to the ON position.

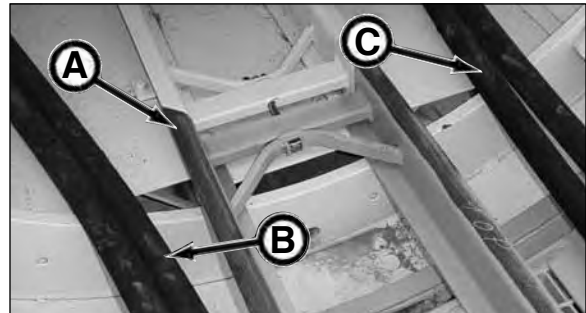

WARNING

Suspended loads may fall and cause severe injury or death. Do not allow anyone to enter area under or around a suspended load.

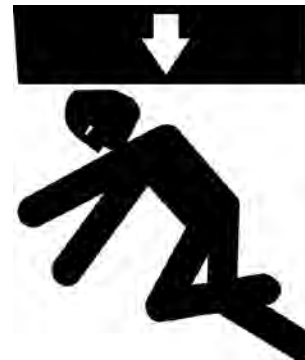

22. Lower haul unit onto the track with the operator end of the haul unit installed towards the front of the TBM.



(continued on next page)

23. Recheck laser guidance system accuracy often (both with and without forward thrust applied) to avoid making improper steering corrections. In most situations, the conveyor must be lowered to check line and grade target.

NOTICE The more often the target position is checked, the less adjustment that will be required.

NOTICE Relevel inner drum every time the target position is checked.



24. Lower dirt bucket into place on the haul unit.

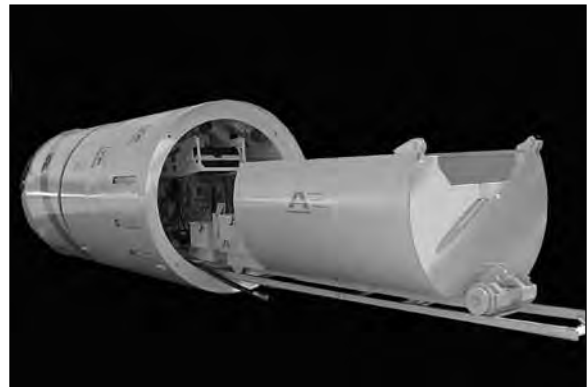

⚠ WARNING Avoid contact with conveyor. Failure to do so could cause severe injury or death.

While moving the haul unit into the tunnel, avoid hitting the conveyor and other obstructions.



(continued on next page)

NOTICE

For information on operating the haul unit, refer to Operating The Haul Unit in the Operation section of your Haul Unit Operator's Manual.

25. Move the haul unit to the front of the tunnel until dirt bucket is in position to catch spoils from conveyor.

NOTICE

Haul Unit track can get slippery. Therefore when operating the haul unit, **GO SLOW!** Also, remember that the haul unit forward momentum will carry the haul unit past the point where the brake is applied.



26. Continue pipe jacking process for each additional pipe section (adding hydraulic hose, power cables, ventilation supply, bentonite hoses, IJS hoses and track as necessary, refer to Adding Pipe in this section) until pipe line is complete. When pipe line is complete, refer to Removing Jacking System in this section.

NOTICE

If there is a possibility that the maximum jacking capability will exceed the maximum jacking force of your jacking system or pipe, intermediate jacking stations should be installed (refer to Using Intermediate Jacking Stations in this section).



OPERATING THE CONVEYOR

⚠ WARNING Conveyor can jam in rotating cutterhead causing conveyor to swing into operator, resulting in severe personal injury. While cutterhead is rotating:

1. Operator **MUST** remain seated in normal operating position.
2. The conveyor safety valve (cutterhead drive dump valve) **MUST** be tethered to conveyor and the operation **MUST** be tested before starting the conveyor to insure proper operation.
3. ALL FOUR safety chains **MUST** be secured to conveyor.

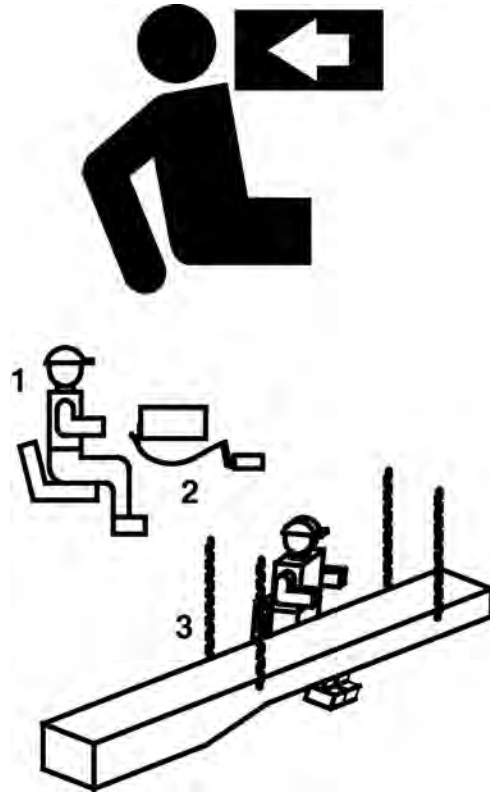

Conveyor Operation Guidelines:

1. Check conveyor for damage before operating. Repair or replace damage or wear before operating.
2. Operator **MUST** remain seated in normal operating position.
3. Cutter head drive dump valve cable (stop cord) **MUST** be tethered.
4. ALL FOUR safety chains **MUST** be secured to conveyor before operating inner drum.
5. Avoid contact with conveyor.
6. Keep hands, body, and objects clear of operating conveyor.
7. Do not operate without covers and guards in place.
8. Lockout power before performing maintenance or repairs on conveyor.
9. NEVER perform maintenance to conveyor while the conveyor is running.
10. While conveyor is running, DO NOT try to dislodge material from pulleys.
11. NEVER use a shovel, or other hand tool to clean material buildup while the conveyor is running.
12. Before operating conveyor, check to be sure the belt is properly tensioned.

1. With conveyor properly installed and all guards in place, inform all personnel in tunnel that the conveyor is going to start up and to stay clear of the conveyor.
2. Move conveyor into operating position with conveyor lift control (A), using control to adjust lift speed.

⚠ WARNING Adjusting the lift speed too quickly for the operator to handle could cause severe injury or machine damage.



(continued on next page)

3. Move dirt bucket into position to catch spoils from conveyor.



WARNING Running the conveyor too fast can cause severe injury from flying debris and cause possible machine damage. Slow the conveyor speed so there is continual controlled movement of the spoils into the dirt bucket.

4. Operate conveyor control (A) to control the direction and speed of the belt or auger conveyor.

The further the lever is moved from neutral, the faster the conveyor belt or auger will move. This control also is equipped with a friction detent, so the lever will remain in the desired position until you move it back to neutral position.

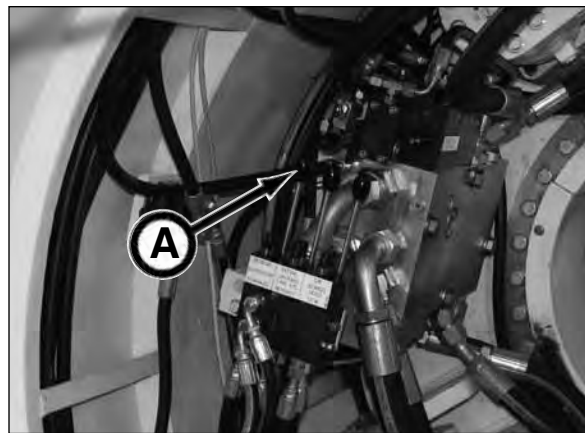

NOTICE Control the speed of the conveyor so when the spoils drop on the conveyor, they do not pile up on the belt or in the auger. A change in ground conditions will require periodic adjustments to the conveyor speed.



MAKING STEERING ADJUSTMENTS

NOTICE Steering adjustments are typically made when the dirt bucket is removed from the launch shaft, then the conveyor is lowered to expose the laser beam on the target bolt area.

NOTICE The more often the target position is checked, the less steering adjustments will be required.

When steering corrections are necessary, be sure to **make ONLY minor adjustments over several feet**. Making more extreme steering adjustments will increase the jacking forces due to the front and trailing sections are not in parallel.

At initial start up, the steering cylinders should all be set at the 50% cylinder position cylinder extension:

- 48SC, 420, 480, 540, 600: **2.0" (51 mm)**
- 660, 720, 780: **3.0" (76 mm)**

Move steering cylinders as follows:

Steer UP

Extend the left (A) and right (C) cylinders the same amount or retract the top (B) cylinders.

Steer DOWN

Extend the top (B) cylinders or retract the left (A) and right (C) cylinders the same amount.

Steer LEFT

Extend the right (C) and retract the left (A) cylinders the same amount or;
Extend the right (C) cylinders and then the top (B) cylinders half the amount of the right cylinders.

Steer RIGHT

Extend the left (A) and retract the right (C) cylinders the same amount or;
Extend the left (A) cylinders and then the top cylinders (B) half the amount of the left cylinders.

PRESSURE GAUGES

The Steering PSI gauges show the active pressure in the cylinders. Pressures may exceed 3,000 psi due to high jacking pressure because of hard ground conditions or over advancement by the pump unit operator.

IMPORTANT: During TBM advancement, DO NOT EXCEED the maximum rated steering cylinder pressure (see below). Doing so will cause hydraulic component, main bearing and structural damage.

48SC	4,500 PSI	420	5,000 PSI
480	4,400 PSI	540	4,200 PSI
600	5,000 PSI	660	4,100 PSI
720	4,800 PSI	780	4,100 PSI

Steering Cylinder Pressure - Left (D)
Steering Cylinder Pressure - Top (E)
Steering Cylinder Pressure - Right (F)
System Pressure (G)

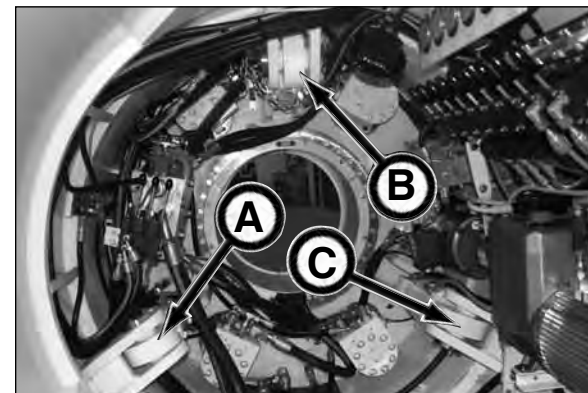
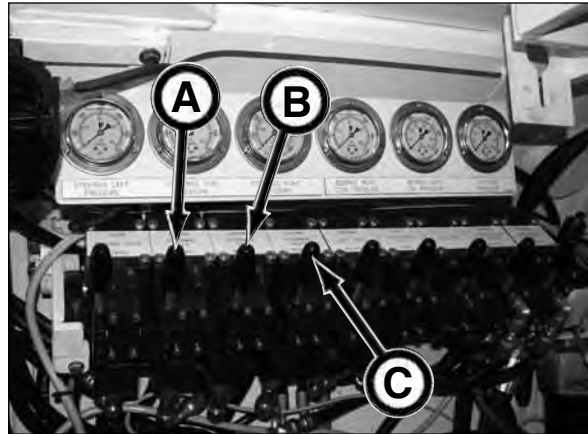

420 Series II

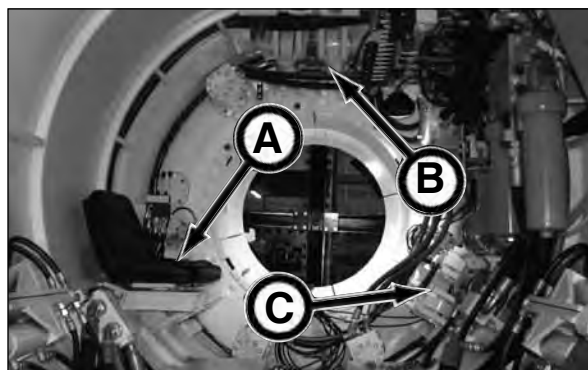

600 Series II

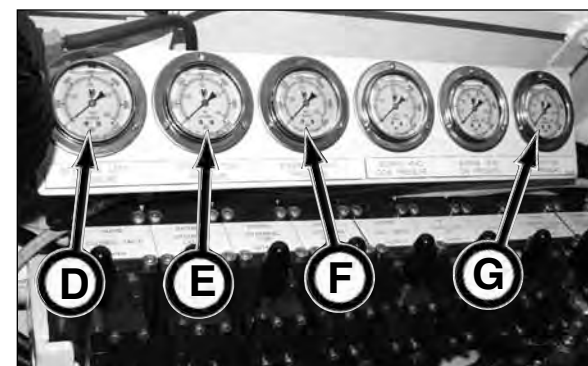

ACCESING FRONT OF TBM / ENCOUNTERING AN OBSTRUCTION

To access the front of the machine and the face of the bore, retract the steering cylinders with control levers (A, B, & C). Be sure to perform the lockout, tagout procedure before accessing the front of the TBM to prevent accidental startup.

This method allows for the removal of large obstructions, whether planned or unexpected and makes it easy to perform routine maintenance and repairs.

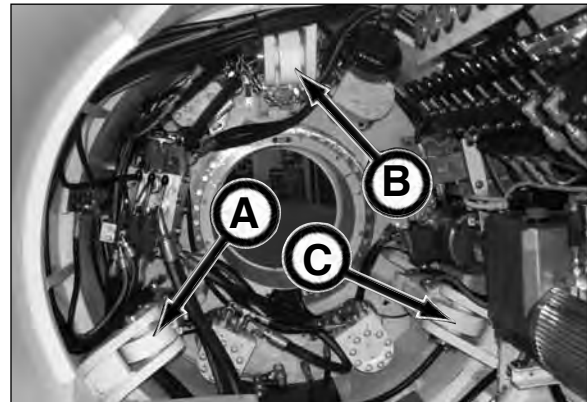
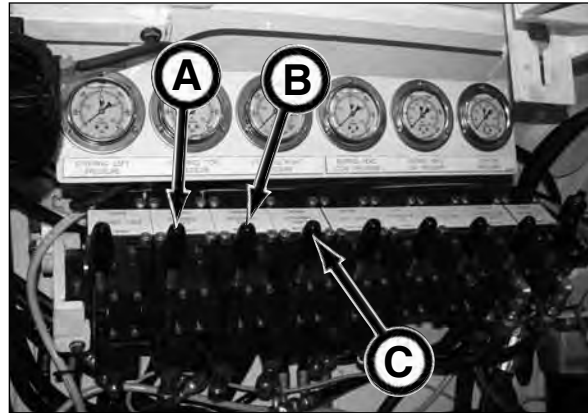

420 Series II

ADJUSTING TBM ROLL

If the TBM rolls 1/4" to 1/2" (6 to 13 mm) from level, the torque wings or dirt wings need to be extended. The torque wings and dirt wings (D) are fully extended when the system pressure gauge (E) reads 2,800 - 3,000 psi.

Control the TBM roll with torque wing lever or dirt wing lever (F) as follows:

TORQUE WINGS (Straight Non-directional Fins)
 Extend torque wings to help stabilize the roll by holding the position of the TBM. Change the cutter head rotation as needed to control the roll.

DIRT WINGS (Directional CW-CCW Fins)
 Extend the dirt wings to control the roll without the need to change the cutter head rotation.

Example when using CW dirt wings:

- Operator side is low: extend dirt wings
- Operator side is high: retract dirt wings

Keep the torque/dirt wings extended until the TBM roll is back to level position.

If needed, bolt-on and hydraulic clockwise and counterclockwise dirt wings, and extensions are available. Contact your Akkerman Aftermarket Support representative for more information.

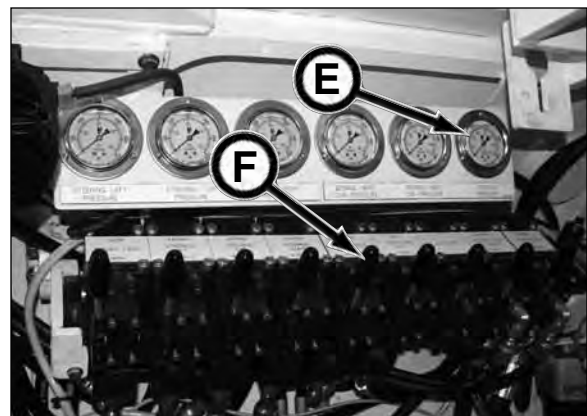
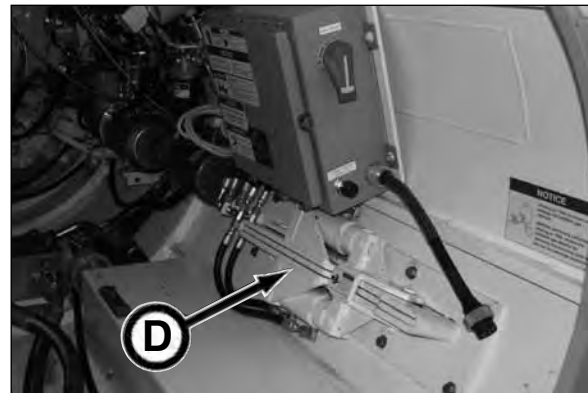

USING GAS DETECTOR

Refer to your Gas Detection System Operation & Parts Manual for properly operating the gas detector.

⚠ DANGER Be aware that the harmful effects of entering an oxygen-deficient atmosphere can be so immediate that it is impossible to retreat to safety.

The gas detection system installed in the TBM system, monitors only methane gas levels.

Monitoring of all gas levels is the responsibility of the contractor. This includes the accumulation of combustible and toxic gases, and depletion of oxygen. The contractor must keep the tunnel ventilated with fresh air.

The gas detection system installed in the TBM CANNOT be the only methane or other combustible monitoring system. The gas concentration must be checked by other portable detectors to inspect the tunnel at the beginning of each shift to determine that the tunnel is gas free before any tunnel equipment is energized or personnel are allowed to enter the tunnel. The contractor is responsible for providing air analyzers to detect hazardous gases or oxygen deficiency on the job and in the tunnel at all times.



USING HAUL UNIT

⚠ WARNING Contacting tunnel wall and boring head components can cause severe injury or death. Keep all body parts on Haul Unit while unit is moving.

Refer to your Haul Unit Operator's Manual for the proper safety, operation, and maintenance information.

Keep all tooling or other support equipment off of the haul unit.



524 Haul Unit With Dirt Bucket

ADJUSTING OVERCUT

The typical overcut is 1.50" (38 mm) larger than the product pipe diameter, which allows space for steering and the addition of bentonite. Keep in mind that too large of an overcut can lead to uncontrollable steering. Contact your Akkerman Aftermarket Support representative if your desired overcut is more than 1.50" (38 mm).

1. Loosen set screws (A).
2. Readjust bolt (B) to move cutter (C) to desired overcut. Be sure both cutters are adjusted to the same overcut length.
3. Retighten set screws (A).

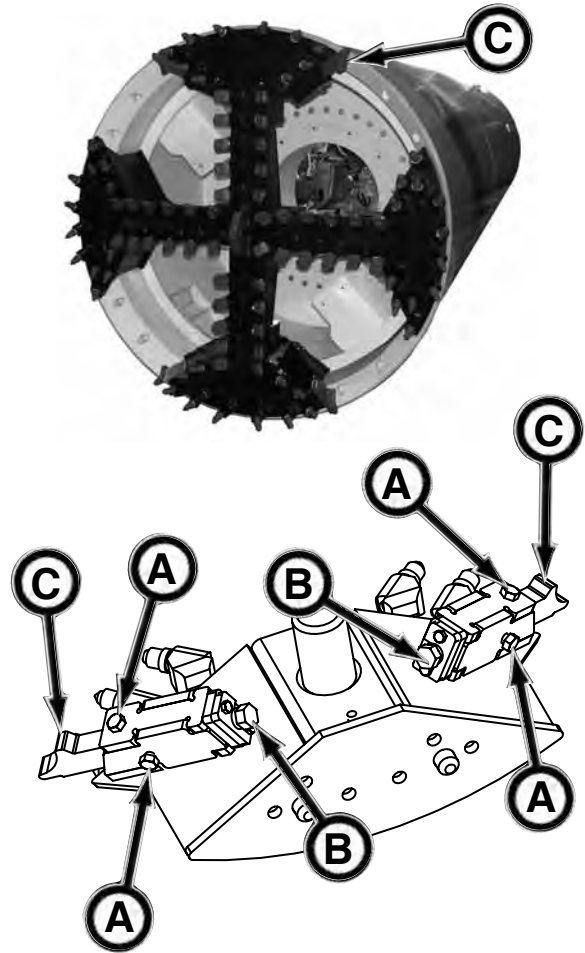

SAND SHELF OPERATION

The sand shelves are designed to be used in loose unstable, non-adhesive soils, but not flowing. The TBM and sand shelves become stabilizers for the earth and prevent the soil from collapsing in front of the TBM to prevent over excavation.

When using the sand shelves with the TBM, there is no mechanized means of excavating material in front of the TBM. All mechanical work is done by thrusting (jacking) the TBM cutting ring into the ground, material falls into the inner drum assembly and is loaded onto the conveyor for transport out of the tunnel via a haul unit.

Minimizing frontal contact area and decreasing required advancement tonnages are critical when using the sand shelves. The leading edges of the TBM cutting ring and the sand shelves are tapered like a knife edge to reduce steering and jacking tonnages. Therefore, never use a TBM equipped with sand shelves in soil conditions, such as clay or soft to medium hard rock, where a TBM equipped with a carbide cutter head should be used. Doing so will cause TBM component and structural damage.



USING CLOSED FACE OR AUXILIARY CONTROL

The Closed Face lever (A) controls the opening and closing of the doors on the optional closed face cutter head attachment. Used in unstable ground conditions, the hydraulically operated doors control subsidence of loose soil while excavating the ground.

Move the lever as follows:

- UP - close doors
- DOWN - open doors

A lubrication system (two water/lubrication ports on cutter head) is equipped on the closed face attachment to provide a method to lubricate the face if needed. If the water ports are not used, be sure the lines are purged with grease by removing plugs on front of closed face attachment, then fill lines with grease through grease fitting on manifold block. Replace plugs on front of closed face.

Operating Guidelines:

1. Open doors only as needed while advancing to prevent over excavating.
2. Connect water/lubrication hose to 1/2" fitting on closed face attachment to lubricate clay or abrasive materials.
3. At each shift change, or at the end of the day, close doors to prevent material flow into the TBM.
4. If it becomes necessary to enclose the inner drum to control subsidence of loose soil from entering the TBM, such as at the end of the day, add dirt scoop covers and outside scraper covers.
IMPORTANT: Do not operate with covers in place. Doing so will cause premature failure to the TBM seals and/or bearing.

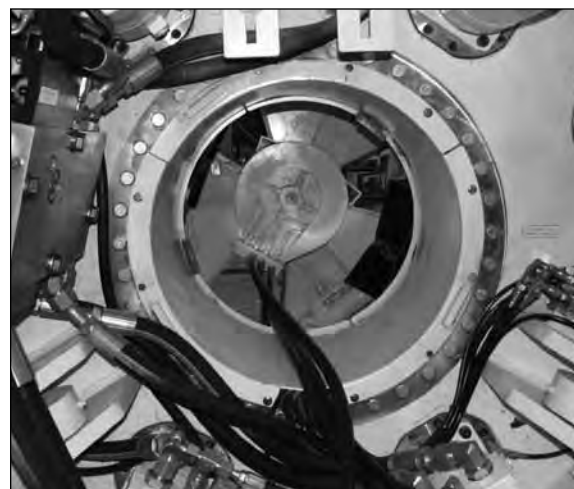
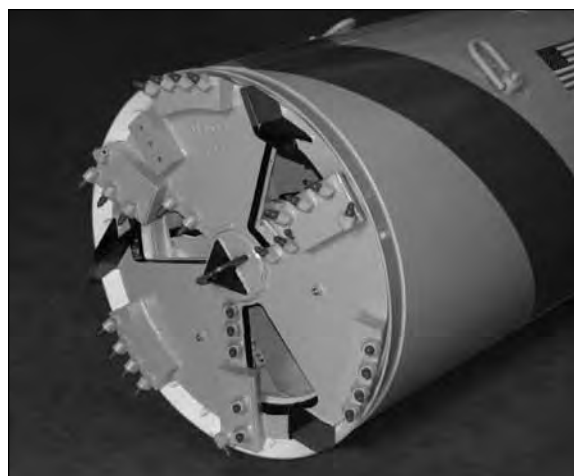
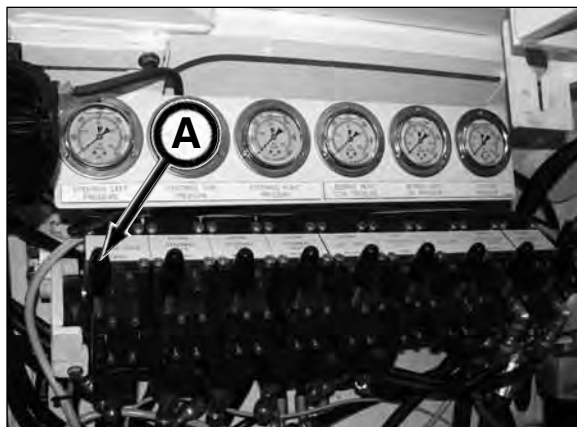

ADDING PIPE

⚠ WARNING Suspended loads may fall and cause severe injury or death. Do not allow anyone to enter area under or around a suspended load.

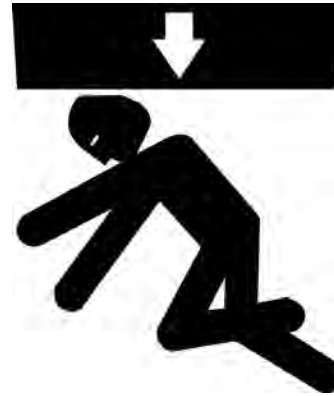

1. Continue jacking until the TBM has been jacked far enough into the ground to allow adequate space to add one section of pipe.

NOTICE While operating TBM, periodically check to be sure the bearing oil lubrication pump, seal grease pump and scavenging pump are functioning properly.

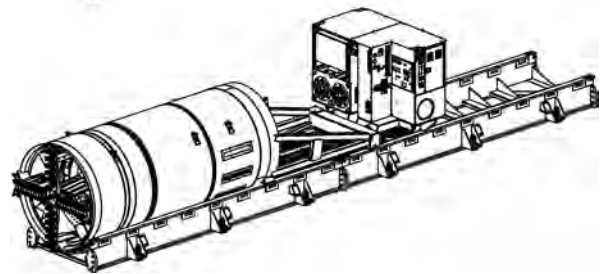

2. Return all hydraulic controls on the pump unit and TBM to the OFF or neutral position.

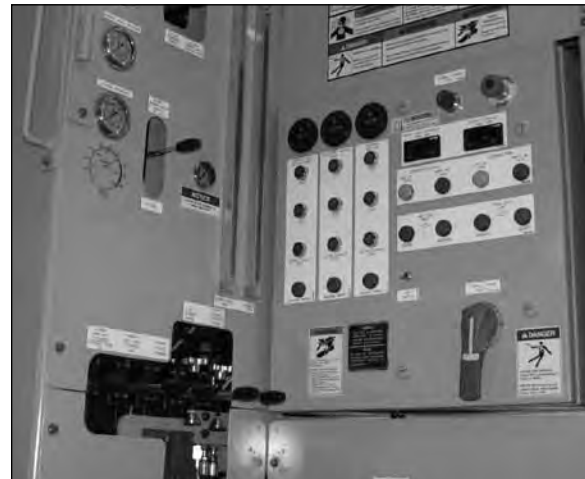

5000 Series II Pump Unit

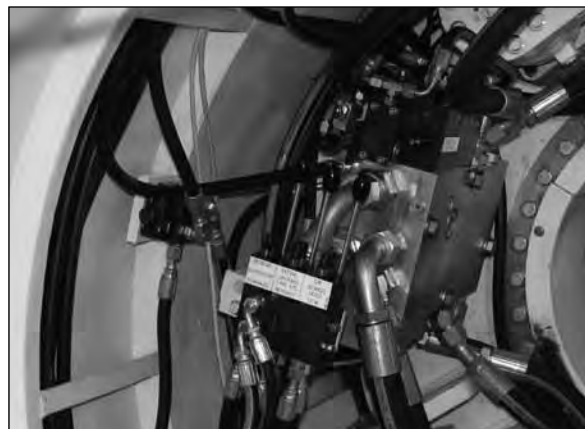

420 Series II

3. (5000 Series II Pump Unit) Stop the boring head and auxiliary motors by depressing the Boring Head STOP button (A) and the Auxiliary Motor STOP button (B).

IMPORTANT: Boring Head and Auxiliary Motors MUST be in STOP position BEFORE disconnecting hydraulic hoses/lines. Doing so will release hydraulic pressure in the hydraulic hoses.

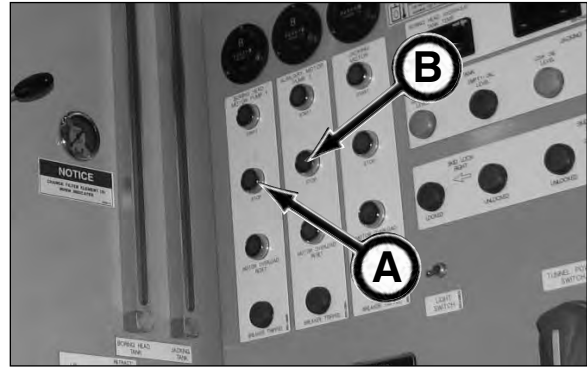

⚠ DANGER Contact with electrical power WILL cause severe injury or death from electrical shock. NEVER disconnect tunnel power cables when tunnel power light is ON.



4. Move Tunnel Power switch (C) (on pump unit) to the OFF position. Place switch in lockout/tagout to prevent any accidental powering of TBM.

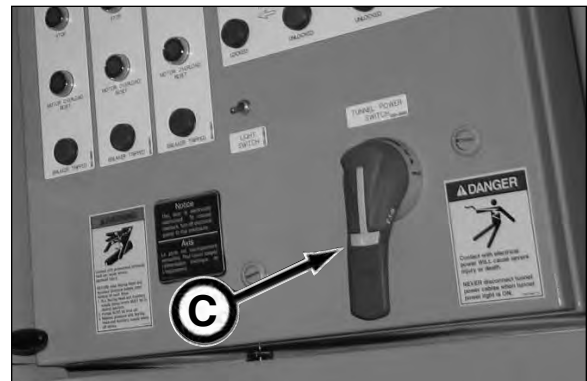

5. Move the TBM Main Power switch (D) to the OFF position and push TBM E-Stop (E) IN.



⚠ WARNING Escaping oil or other fluids under pressure can penetrate your skin causing serious injury or death.

Release all pressure before performing maintenance or repairs. Never weld near pressurized fluid lines.

DO NOT use your hands to check for leaks. When searching for leaks, use a piece of wood or cardboard.

Contact medical help immediately if any oil or fluid is injected into your skin. A serious infection or reaction can emerge without proper medical treatment.



IMPORTANT: BEFORE connecting or disconnecting hydraulic oil hoses/lines, **ALWAYS** move hydraulic controls (A) to the OFF or neutral position, STOP the boring head and auxiliary motors (B) AND use gloves.

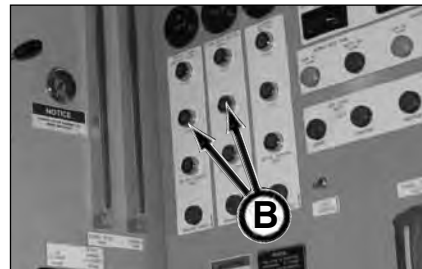
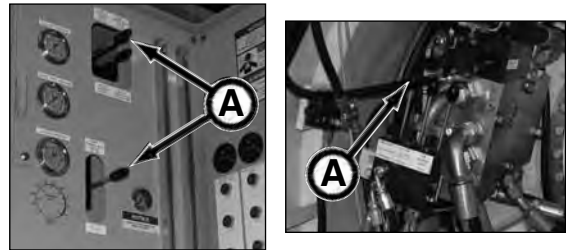

6. With gloves, disconnect pump unit supply and return hoses from TBM supply and return line hoses. Cap hoses.



⚠ DANGER Contact with electrical power WILL cause severe injury or death. NEVER disconnect tunnel power cables when tunnel power light is ON. The tunnel power switch MUST be in lockout/tagout before connecting or disconnecting power cables.



7. Disconnect the 480V electrical cable, communication line, ventilation supply, bentonite hoses (if used), and IJS hydraulic hoses and cable (if used). Be sure all electrical lines, hose connections and cables are positioned in a clean, dry location and are out of the way of the next pipe, and any pinch point areas.

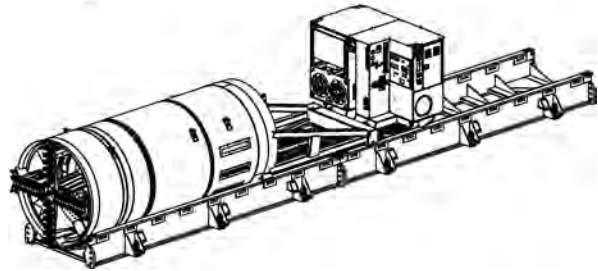

8. Disconnect track from pipeline.

9. Perform a visual machine inspection by checking the following items: all fluid levels, leaks, filter indicators and machine damage. Make repairs before operating.

10. Start the pump unit jacking motor (A) (if not already running) and retract pump unit and yoke back far enough to lower a section of pipe.

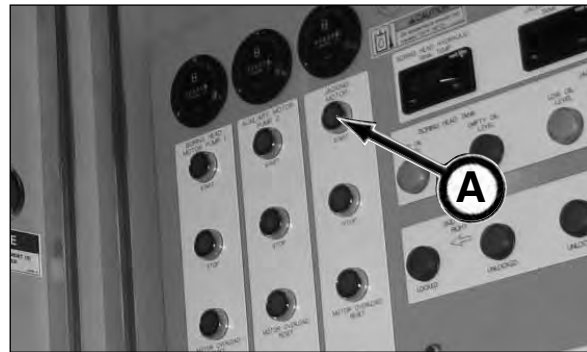

11. Lower the next pipe into shaft and wipe off and lubricate the sealing ring to ensure proper sealing before setting pipe.



12. Use pump unit controls to travel to back of pipe and mate the yoke with the pipe.



13. Use pump unit controls to mate pipe with TBM.



⚠ DANGER Contact with severed electrical cables WILL cause severe injury or death. Constantly monitor electrical cables during the jacking process to prevent cutting or stretching of any electrical cables.



14. Clean electrical and hose connections before reinstalling.
15. Reinstall TBM hydraulic supply and return hoses, vent supply, 480V electrical cable, communication line, bentonite hoses (if used), and IJS hydraulic hoses and cable (if used).

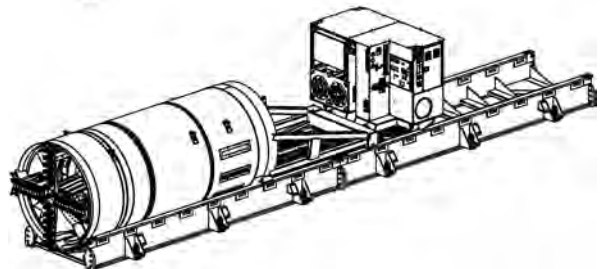

16. Install new pipe track to pipeline track. Sections of track will need to be added as new pipe is lowered. Be sure there is always track connecting the pipeline and the yoke for the haul unit and the loading and unloading of the dirt bucket.



17. Once it is communicated to all job site personnel that the TBM power and the machine operation will be resumed, remove lockout/tagout from Tunnel Power switch (A).

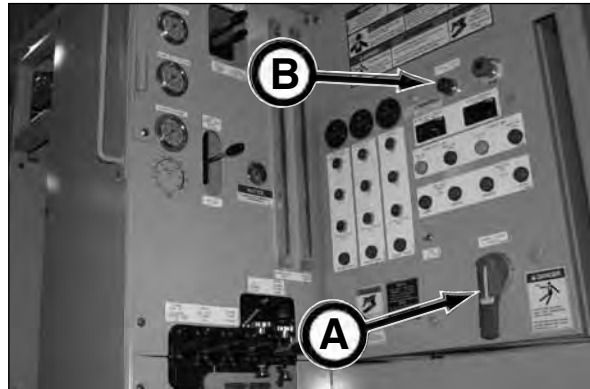

18. Move Tunnel Power switch (A) on pump unit to the ON position. This will illuminate the Tunnel Power ON light (B) which provides the operator a quick visual indicator that power is ON in the tunnel and to take all necessary precautions with high voltage electricity.

19. Check to be sure the Tunnel Power Phase OK light (C) in the TBM is illuminated before starting power in TBM.

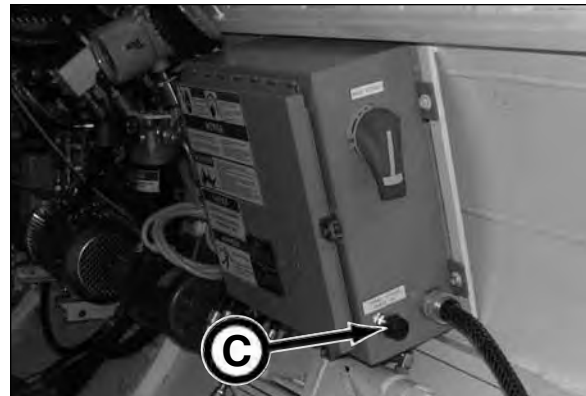

⚠ DANGER Staring into laser light will cause severe injury. Do not stare into laser guidance system light beam. Avoid direct eye exposure.

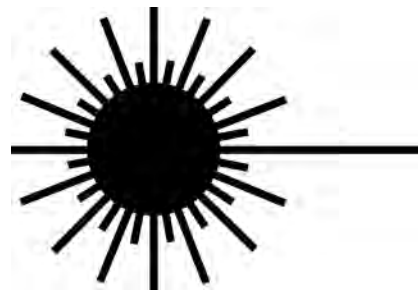

20. Recheck laser guidance system accuracy often, with and without forward thrust applied, to avoid making improper steering corrections.



21. Repeat pipe installation for subsequent pipe.

USING INTERMEDIATE JACKING STATIONS (IJS)

Intermediate Jacking Stations (IJS) are generally used when the thrust pressure reaches one third of the maximum pressure capacity of the pump unit or one half of the thrust capacity of the IJS, whichever occurs first. Contact the Akkerman Aftermarket Sales Department for more information on the proper setup and usage of IJS.

INSTALLING IJS

⚠ WARNING Suspended loads may fall and cause severe injury or death. Do not allow anyone to enter area under or around a suspended load.

1. Lower IJS with the inner ring towards the front of the tunnel, between the leading pipe and the trailing pipe.



NOTICE IJS configurations may vary depending upon project requirements.

2. With the IJS lowered onto the skid assembly, cut inner ring flange (A), located at seam of sleeve, with torch and unbolt plate (B) before mating pipe with IJS.

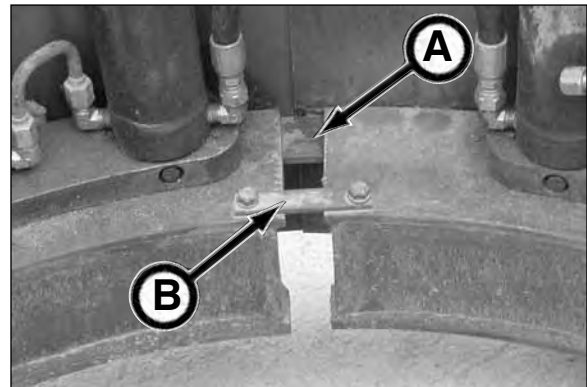

⚠ WARNING Pinch Points! Watch your fingers, hands, and legs while installing IJS sleeve.

3. SLOWLY jack until the trailing pipe slides into IJS sleeve and the IJS sleeve slides over leading pipe.
4. Use a winch or turn-buckle to squeeze the IJS sleeve until it mates with the leading and trailing pipe.
5. Tack weld seam.
6. Torch off lifting eyes.
7. Completely weld seam. Reweld flange (A) if possible.
8. Install track and sliding track. Be sure no track joints are in IJS opening.



(continued on next page)

9. (5000 Series II Pump Unit)
Connect hydraulic hoses to Pump Unit.

- a. Connect quick coupler (A) to intermediate jacking station valve pressure port. Use hose rated for at least 6,000 psi working pressure ONLY.
- b. Connect coupler (B) to the IJS tunnel return line.

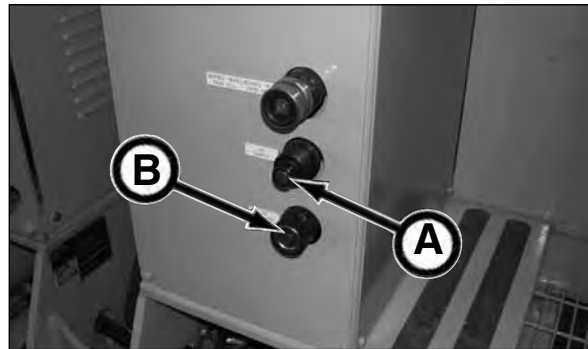

5000 Series II Pump Unit IJS Connections

10. Mount the IJS valve (C) between cylinder segments (D).

11. Connect hydraulic hoses to IJS valve:
- a. Pressure to port P
 - b. Return to port T
 - c. Connect cylinders to C ports

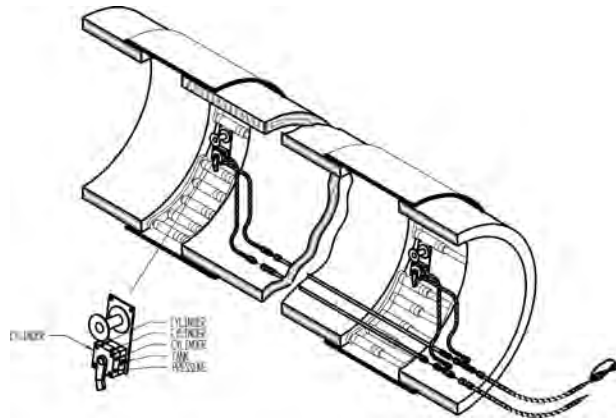
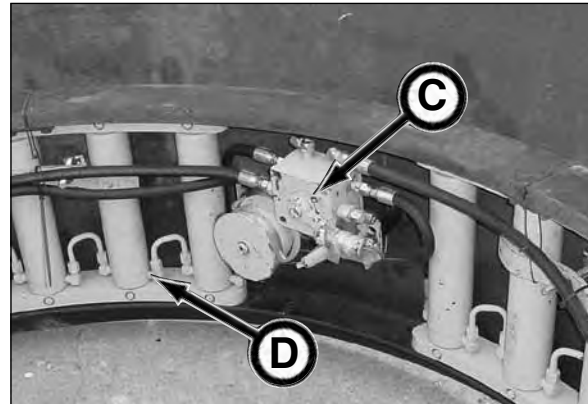

12. Secure cable weight to IJS line holder (E) on yoke or jacking frame.

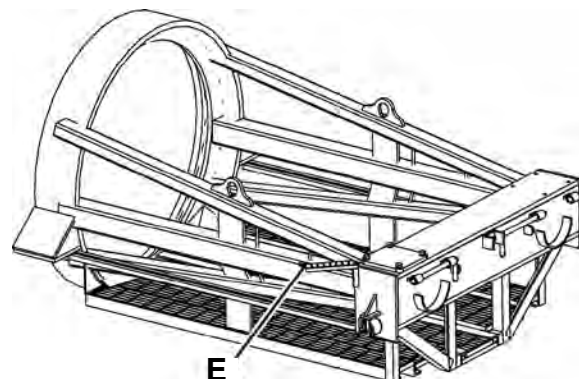

(continued on next page)

OPERATING IJS

13. (5000 Series II Pump Unit) Start jacking motor by depressing jacking START button (A).

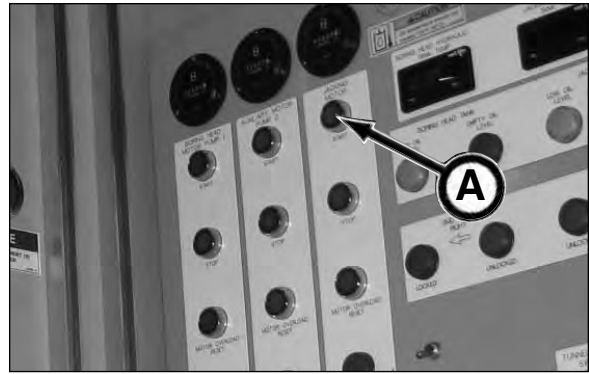

14. Pull cable for IJS #1 on IJS line holder (B) to open valve and extend IJS cylinders by moving the IJS cylinder control DOWN. Operate the boring head the same as if the TBM is being jacked with the main ram cylinders for IJS #1.
15. When the IJS cylinders (for IJS #1) are at full extension, the pressure on the jacking pressure gauge should start to climb rapidly.
16. Release cable and IJS cylinder control.
17. Pull cable for IJS #2 to open and operate IJS cylinder control to close IJS #1 by extending cylinders. When the IJS cylinders are at full extension, the pressure on the jacking pressure gauge should start to climb rapidly.

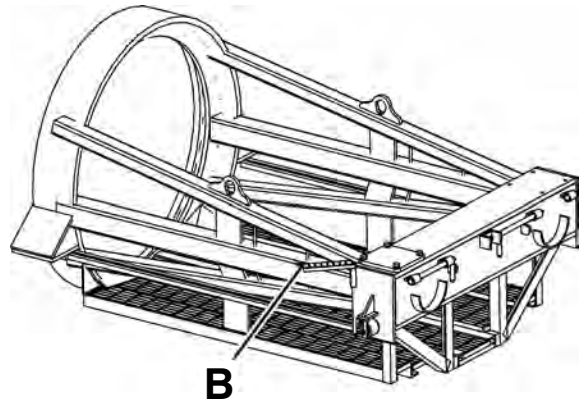

NOTICE DO NOT operate TBM cutterhead when extending cylinders for IJS #2, IJS #3, etc. or when closing final IJS.

18. Release cable and IJS cylinder control.
19. Pull cable for IJS #3 to open and operate IJS cylinder control (extend IJS cylinders) to close IJS #2. When the IJS cylinders are at full extension, the pressure should start to climb rapidly.
20. Release cable and IJS cylinder control.
21. Repeat this opening and closing process for any additional IJS.



Extending IJS Cylinders

(continued on next page)

22. Continue jacking by extending the main rams cylinders using the jacking cylinder control to close the last IJS.

NOTICE Keep in mind when using the Intermediate Jacking Stations, you are mining with IJS #1, closing IJS #1 with IJS #2, closing IJS #2 with IJS #3, and closing IJS #3 with main rams.



Extending Main Ram Jacking Cylinders

Refer to the IJS Schematic below.

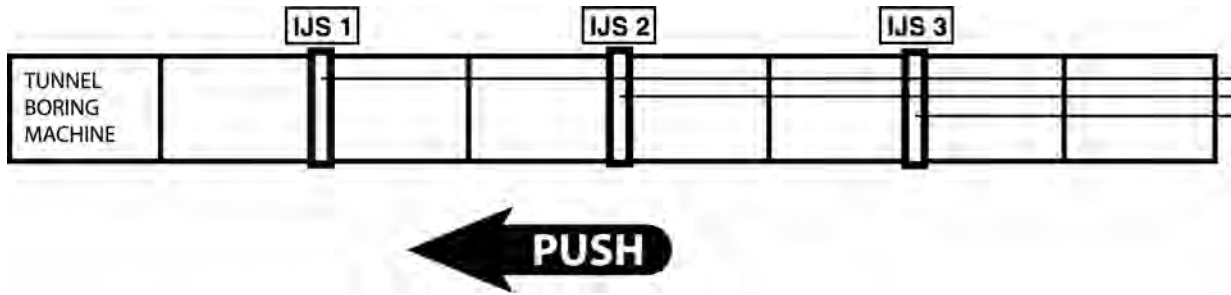

Intermediate Jacking Station Sequence

IJS SCHEMATIC

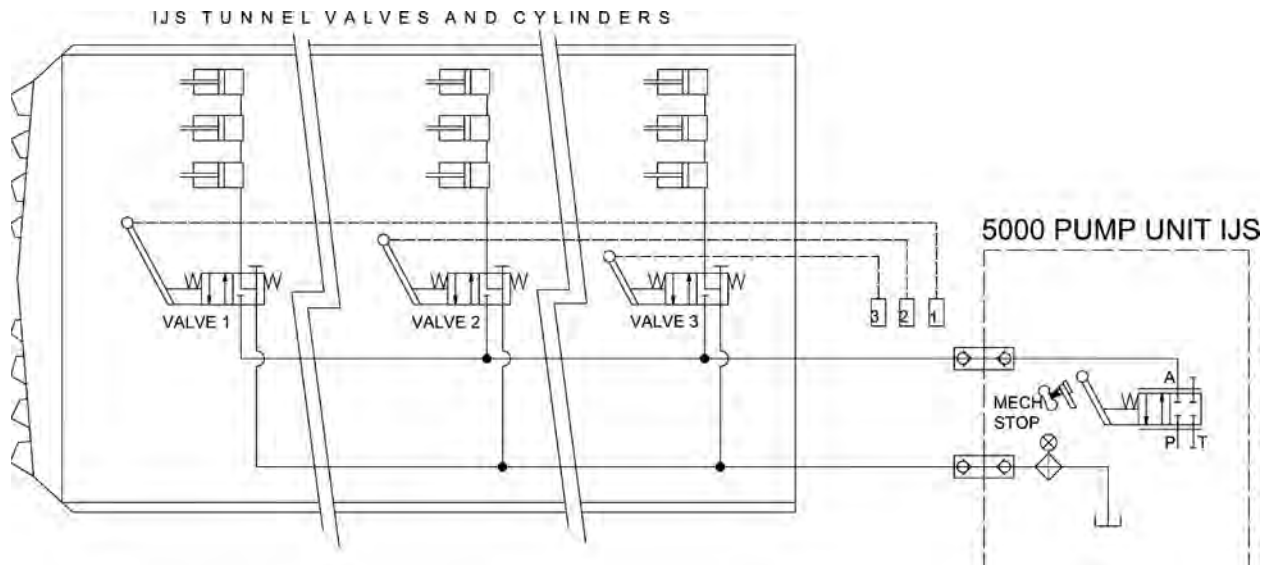

DAILY SHUT DOWN

1. Return all hydraulic controls (A) on the pump unit and TBM to the OFF or neutral position.

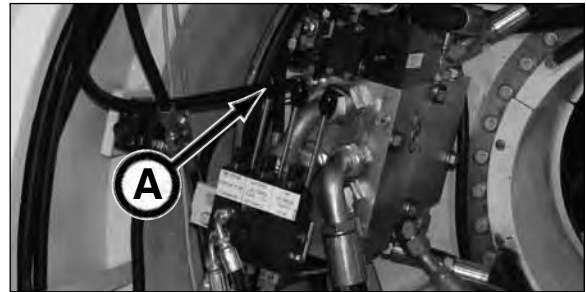
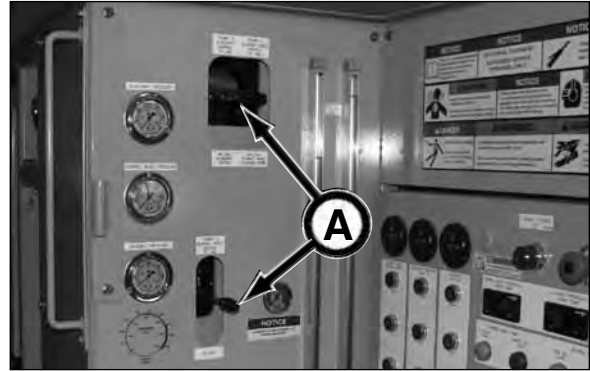

2. (5000 Series II Pump Unit) Stop the boring head, auxiliary and jacking motors (B).

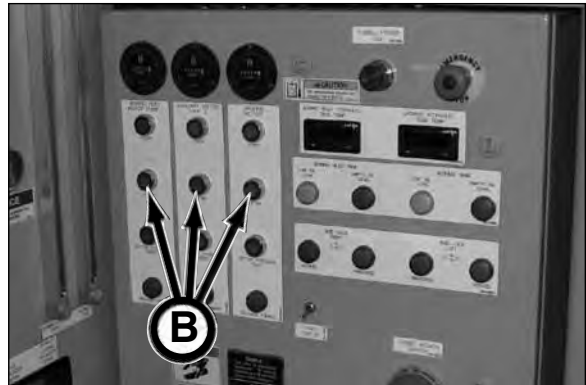

3. Move the TBM main power switch (C) to the OFF position.



4. Push TBM E-Stop button (D) IN.



(continued on next page)
TBMseriesIIom-050076

5. (5000 Series II Pump Unit) Move Tunnel Power switch (A) to the OFF position. Place switch in lockout/tagout.

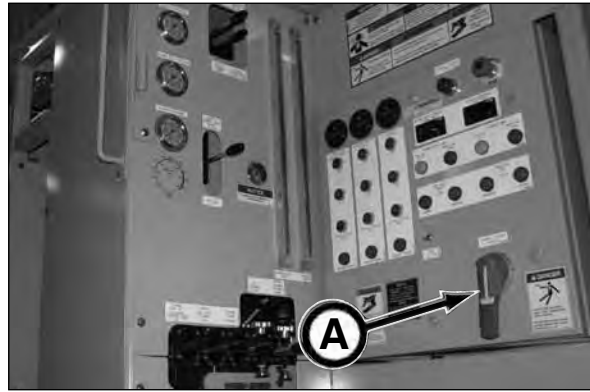

6. Press pump unit E-Stop button IN.



7. Move pump unit Main Power switch (B) to the OFF position and perform lockout/tagout.

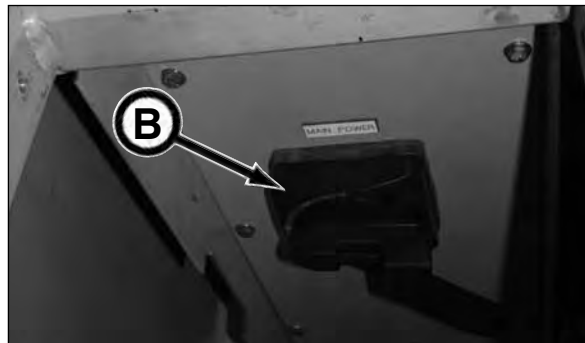

8. Shut off water supply to pump unit heat exchanger. Drain water if freezing temperatures are possible.
9. Shut off main power source and perform lockout/tagout.
10. Perform a visual system inspection by checking the following items: all fluid levels, leaks, and machine damage. Make repairs before operating. Also check to be sure all electrical and hydraulic connections are properly connected and secured.

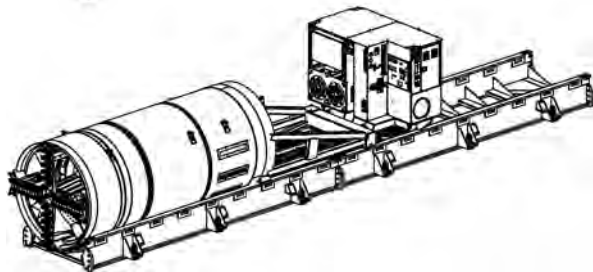

NOTICE

The pump unit and TBM should not be engulfed with water. Damage will result. If equipment becomes engulfed with water, contact your Akkerman Aftermarket Support representative for proper procedures on how to restore equipment for operation.

REMOVING TBM AND JACKING SYSTEM

⚠ WARNING Any electrical work completed on the jacking system **MUST** be performed by a certified electrician.

When pipe line is complete and TBM is in reception shaft, remove the TBM and jacking system as follows:

1. LOCKOUT/TAGOUT power source(s). Push in ALL E-Stop buttons (A).

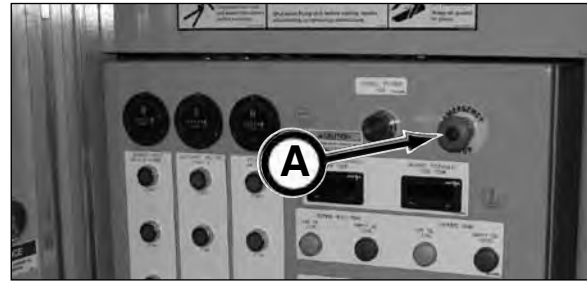

E-Stop on 5000 Series II Pump Unit



Remote E-Stop on 5000 Series II Pump Unit



E-Stop on Series II TBM

2. Move TBM Main Power switch (B) to the OFF position.



3. Depress pump unit STOP button (C) on all motors; boring head, auxiliary and jacking motors.

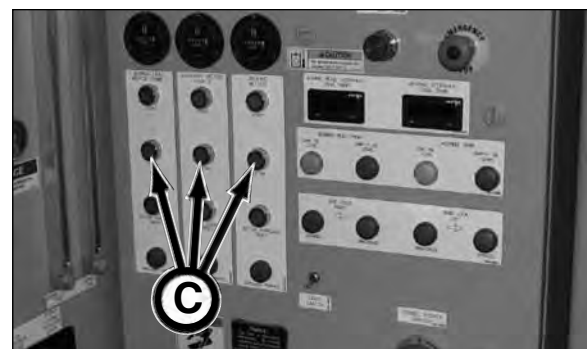

(continued on next page)

4. Move pump unit Tunnel Power switch (A) to the OFF position and perform lockout/tagout.

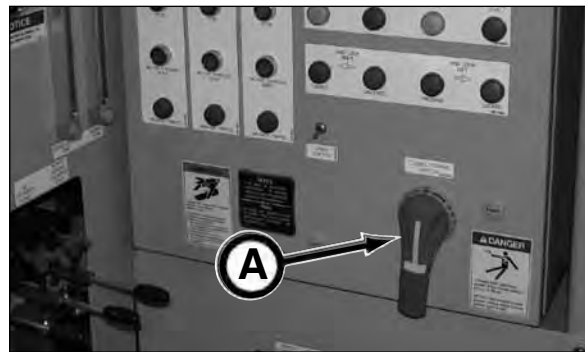

5. Move pump unit Main Power switch (B) to the OFF position and perform lockout/tagout.

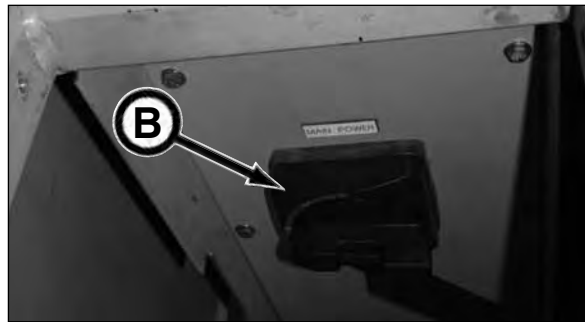

6. Disconnect pump unit tunnel power cable leads from camlock® connections (C).
7. Disconnect tunnel power cable and store cable in clean dry location.



⚠ WARNING Escaping oil or other fluids under pressure can penetrate your skin causing serious injury. Contact medical help immediately if any oil or fluid is injected into your skin.

ALWAYS use gloves when connecting or disconnecting hydraulic oil hoses/lines.

8. Using supply bleed off valves, relieve hydraulic pressure from all TBM and pump unit hydraulic hoses.
9. Disconnect hydraulic hoses and cap hoses. Reclaim oil from hydraulic hoses. Refer to Purging Fluid From Tunnel Lines in section 6, Operation, from your 5000 Series II Jacking System Operator's Manual for more information.
10. Disconnect electrical lines and communication lines.

(continued on next page)



NOTICE If using Intermediate Jacking Stations (IJS), the outer shell will remain in pipe line.

11. If IJS are used:
 - a. remove IJS #1 valve, cylinder segments, and cap hoses, lines, valve and cylinder ports. Cut off valve and cylinder segment bolts. Close IJS #1 gap by operating IJS #2.
 - b. remove IJS #2 valve, cylinder segments, and cap hoses, lines, valve and cylinder ports. Cut off valve and cylinder segment bolts. Close IJS #2 gap by operating IJS #3.
 - c. remove IJS #3 valve, cylinder segments, and cap hoses, lines, valve and cylinder ports. Cut off valve and cylinder segment bolts. Close IJS #3 gap by operating jacking cylinders (if IJS #3 is the last IJS).

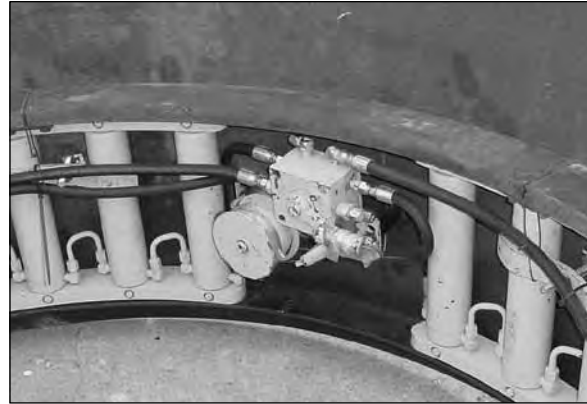

WARNING Suspended loads may fall and cause severe personal injury or death. Do not allow anyone to enter area under or around a suspended load.

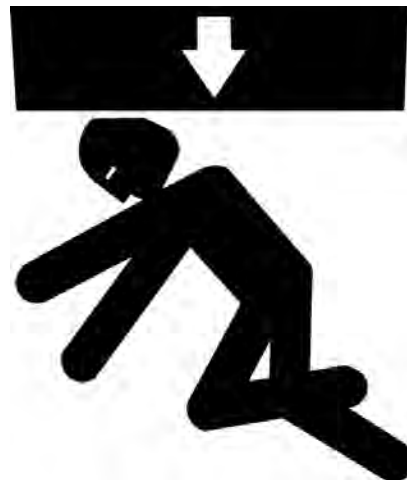

12. Remove 3/4 UNC x 1 bolts from lift eye hole threads and securely install lift eyes to TBM.
13. Remove TBM, haul unit and track.
14. Remove pump unit, yoke and skid(s).



Transporting

TRANSPORTING GUIDELINES

⚠ WARNING Suspended load may fall and cause severe personal injury or death.

Do not enter area under or around a load.



1. Know the local, state, and federal transportation regulations.
2. Obtain required permits for transporting.
3. Remove any obstacles from the trailer floor.
4. Clean debris from equipment.
5. Load and unload on level ground.
6. If lifting equipment with a hoist or other lifting device, the equipment lifting eyes and sling must be inspected for damage before lifting. If damaged, replace.
7. Securely fasten equipment to trailer floor.
8. Secure all loose items.



NOTES

Lubricants

NOTICE

Use of inferior lubricants can affect the efficient performance of your tunnel boring machine equipment. Always use high quality lubricants as specified in this section. Refer to the Periodic Maintenance section for proper lubrication quantity, maintenance intervals, and procedures.

Refer to your Haul Unit and Jacking System Operator's Manuals for proper lubricants.

BEARING CAVITY LUBRICANT

The bearing cavity is filled with Mobilgear® 600XP 460 gear oil. This oil is formulated to provide extra protection for gears, bearings and seals.

Use Mobilgear® 600XP 460 gear oil or equivalent when adding or changing lubricant. Oil must be visible in bearing cavity oil sight gauge (B).

NOTICE

If you change to a different oil, use a reputable oil supplier to meet or exceed the Mobilgear® 600XP 460 oil specification. Do not mix oil manufacturers or grades.

Bearing Cavity Fill Port (A)
Bearing Cavity Oil Sight Gauge (B)

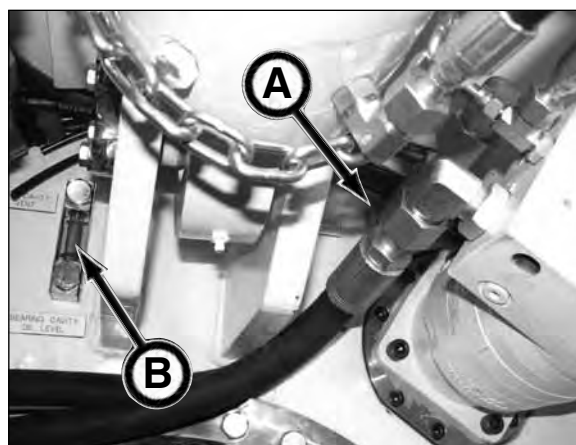

420 Series II

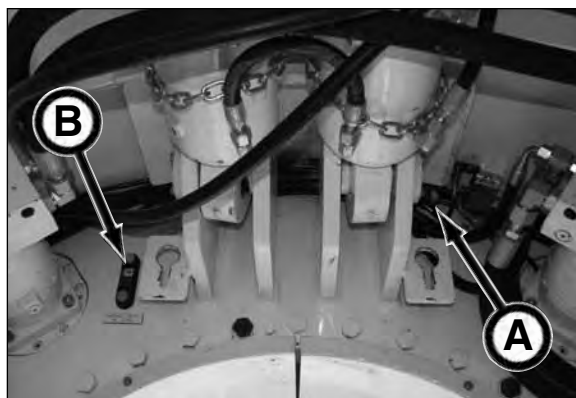

600 Series II

BEARING SEAL GREASE

The bearing seal is filled with Mobil® SHC 101 EAL Grease. This environmental awareness lubricant (EAL) is a multipurpose grease formulated for the lubrication of equipment in environmentally sensitive areas.

Use Mobil® SHC 101 EAL Grease or equivalent for greasing the bearing seal.

Be sure to check the seal grease reservoir level indicator (C) daily to be sure there is ample amount of grease in the reservoir for the shift/day. The typical grease usage is approximately 20 lb of grease for up to 10 hours of use.

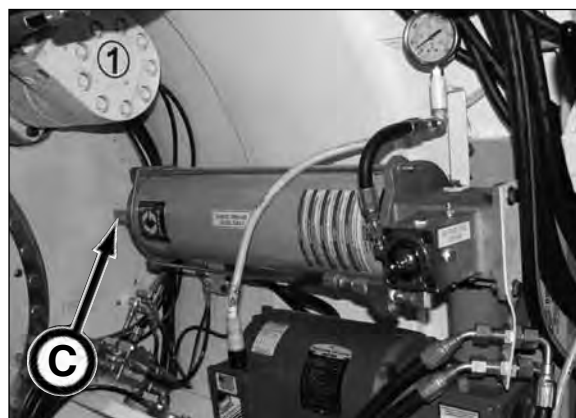

420 Series II

STEERING JOINT GREASE

The steering joint is lubricated with Mobilgrease® XHP222 Premium Lubricating Grease.

The XHP222 grease is a multi-purpose, high performance, high temperature, lithium grease.

Use Mobilgrease® XHP222 Premium Lubricating Grease or equivalent when lubricating the steering joint.

There are three steering joint grease fittings (A). One each at the following locations:
3 o'clock, 6 o'clock and 9 o'clock.

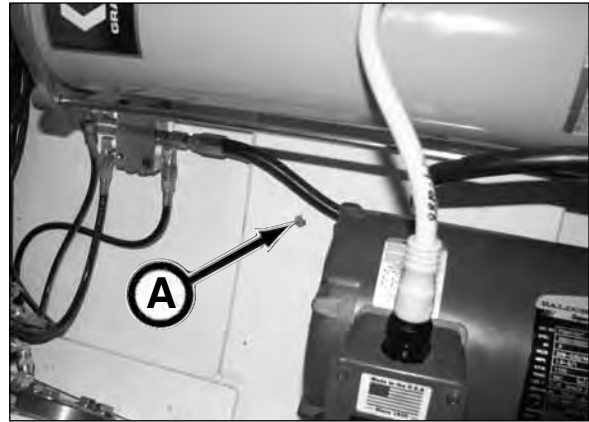

420 Series II

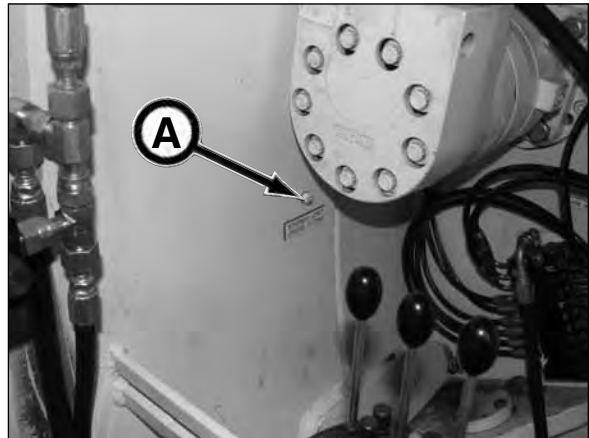

720 Series II

GREASE

The lubrication fittings are greased with Mobilgrease® XHP222 Premium Lubricating Grease unless otherwise specified.

The XHP222 grease is a multi-purpose, high performance, high temperature, lithium grease.

Use Mobilgrease® XHP222 Premium Lubricating Grease or equivalent when lubricating the lubrication points.

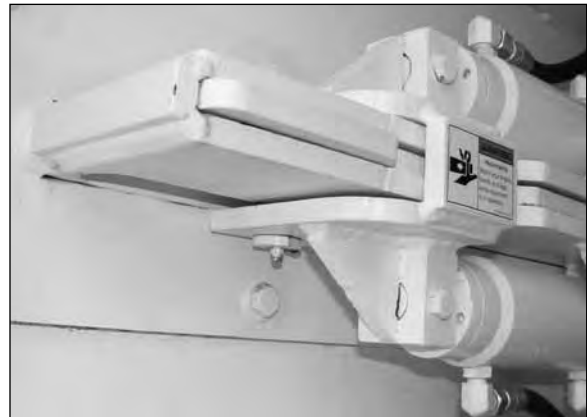

STORING LUBRICANTS

Your equipment can operate at maximum performance only if clean lubricants are used. Use clean containers to handle all lubricants.

Lubricants should be stored in an area protected from dust, moisture, and other contaminants.



Periodic Maintenance

⚠ WARNING Review the Safety section in this manual before performing maintenance. Failure to do so, could cause severe injury or death.

Maintenance and repairs must only be performed by a qualified service technician.

LUBRICATION & MAINTENANCE INTERVALS

The requirements for lubrication and maintenance are shown on the maintenance charts in this section.

Intervals of maintenance are based on normal operating conditions. If operating under more difficult conditions, use a shorter time interval between maintenance.

Use the hourmeters on the 5000 Series II Pump Unit to help determine proper maintenance intervals.

The hourmeters register in full hours and 1/10ths hours.



BEFORE PERFORMING MAINTENANCE

1. Push IN all E-Stop button(s).
2. Relieve hydraulic pressure.
3. Do not work on hydraulic system if oil temperature exceeds 125° F (51° C).
4. **Lockout all power. Perform lockout/tagout procedure.**



LOCKOUT POWER BEFORE SERVICING

⚠ WARNING Severe personal injury or death can result from unexpected pump unit startup or machine movement.

LOCKOUT power before attempting to make repairs or adjustments to this equipment, unless otherwise indicated. Proper lockout will prevent accidents and save lives. Performing the lockout will also prevent the equipment from moving or operating unexpectedly.



1. (5000 Series II) Turn Tunnel power switch (A) to the OFF position. Lockout/tagout switch.

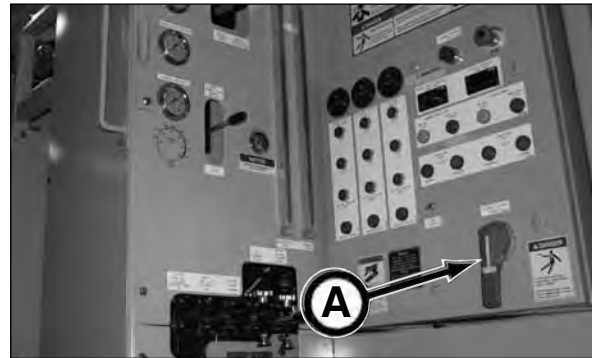

2. (Series II TBM) Turn Main power switch (B) to the OFF position. Lockout/tagout switch.



3. (5000 Series II) Push E-STOP button in.



4. (Series II TBM) Push E-STOP button (C) in.
5. Lockout power source.



HYDRAULIC OIL/FLUIDS UNDER PRESSURE

⚠ WARNING Escaping oil or other fluids under pressure can penetrate your skin causing serious injury or death.

Release all pressure before performing maintenance or repairs. Never weld near pressurized fluid lines.

DO NOT use your hands to check for leaks. When searching for leaks, use a piece of wood or cardboard.

Contact medical help immediately if any oil or fluid is injected into your skin. A serious infection or reaction can emerge without proper medical treatment.



AVOID PINCH POINTS

⚠ WARNING Moving parts or the mishandling of parts can cause severe personal injury.

Keep hands away from moving parts.

Watch your fingers, hands, and legs while equipment is in operation.

Handle parts carefully to avoid crushing and pinch point hazards.



WELDING

UNAUTHORIZED WELDING

⚠ WARNING Unauthorized welding can cause structural failure resulting in possible injury or death.

Do not weld on any structural member. Unauthorized welding or repair will void the warranty.

WELDING ON TBM STRUCTURE

NOTICE Welding on TBM structure will damage the GASMAX gas detector.

BEFORE performing authorized welding on TBM, remove the GASMAX gas detector by removing two mounting bolts and the four pin electrical connector.

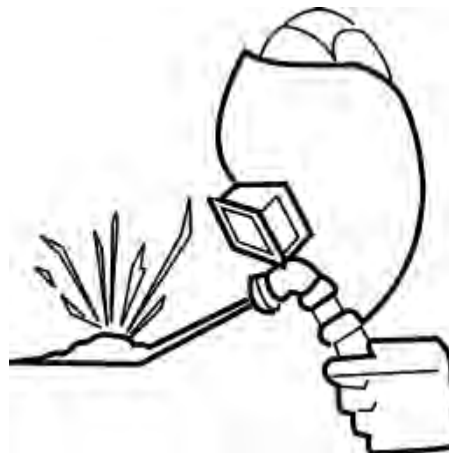

MAINTENANCE CHARTS - TBM

Use the item number in the chart to refer to the detailed maintenance procedures later in this section.

NOTICE

The belt conveyor and screw conveyor maintenance is located later in this section.

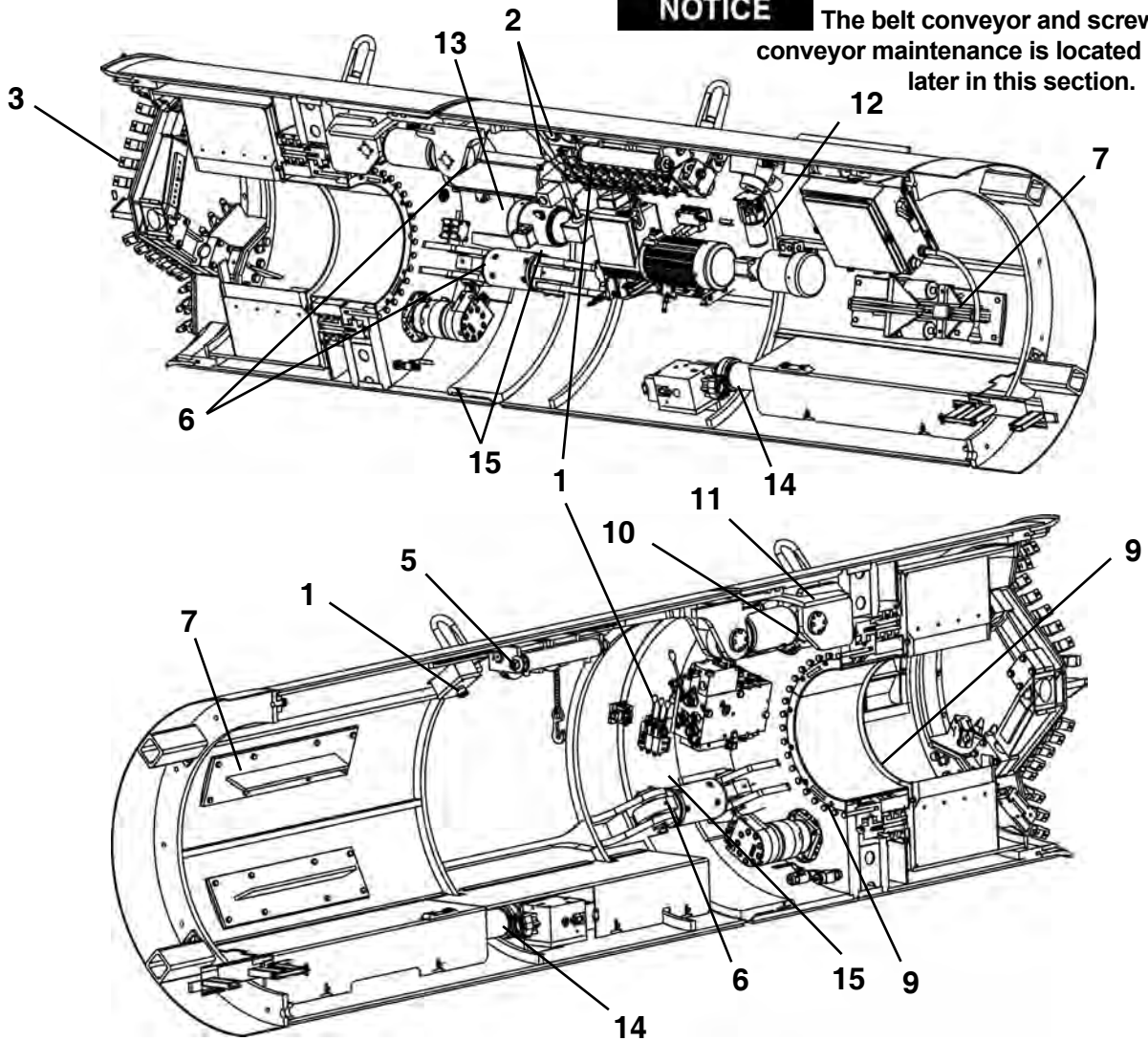

PRIOR TO EACH JOB LAUNCH

ITEM	COMPONENT	SERVICE	REQUIREMENT	MATERIAL
1.	Controls	Check Operation		
2.	Gauge	Check Operation		
3.	Cutter Teeth	Check	Replace if damaged.	
*4.	Steering	Check Line & Grade		
5.	Conveyor Lift	Lubricate (4 places)	Lubricate until grease is forced out.	Mobil XHP222
6.	Steering Cylinder	Lubricate (2 per cyl)	Lubricate until grease is forced out.	Mobil XHP222
7.	Dirt/Torque Wing Pins	Lubricate (2 per cyl)	Lubricate until grease is forced out.	Mobil XHP222
*8.	Closed Face Cyl/Door	Lubricate	Lubricate until grease is forced out.	Mobil XHP222
9.	Inner Drum/Brg Bolts	Check	Visually check for loose/damaged bolts.	
10.	Bearing Cavity Oil	Check Oil Level	Oil must be visible on sight gauge.	Mobil 600 XP 460
11.	Bearing Cavity Vent	Check	Clean if necessary.	
12.	Bearing Oil Filter	Check Filter	Replace filter per indicator.	
13.	Seal Grease Reservoir	Check Grease Reservoir Level	Reservoir must be full.	Mobil SHC Grse 101 EAL
14.	Pressure Filter	Check (2 Filters)	Replace filter(s) per indicator.	Filter Element
15.	Steering Joint	Lubricate (3 places)	Lubricate until grease is forced out.	Mobil XHP222
*16.	Hoses/Pwr Cables	Inspect	Replace if cracks/wear visible.	
*17.	Decals	Inspect	Must be legible. Replace as needed.	
*18.	Haul Unit, Pump Unit & Jack Frame	Perform Maintenance	Refer to your machine's maintenance manual.	

* Not Shown
TBMseriesIIom-050076

Periodic Maintenance - TBM - Daily Or Every 10 Hours Of Operation Or Shift Change

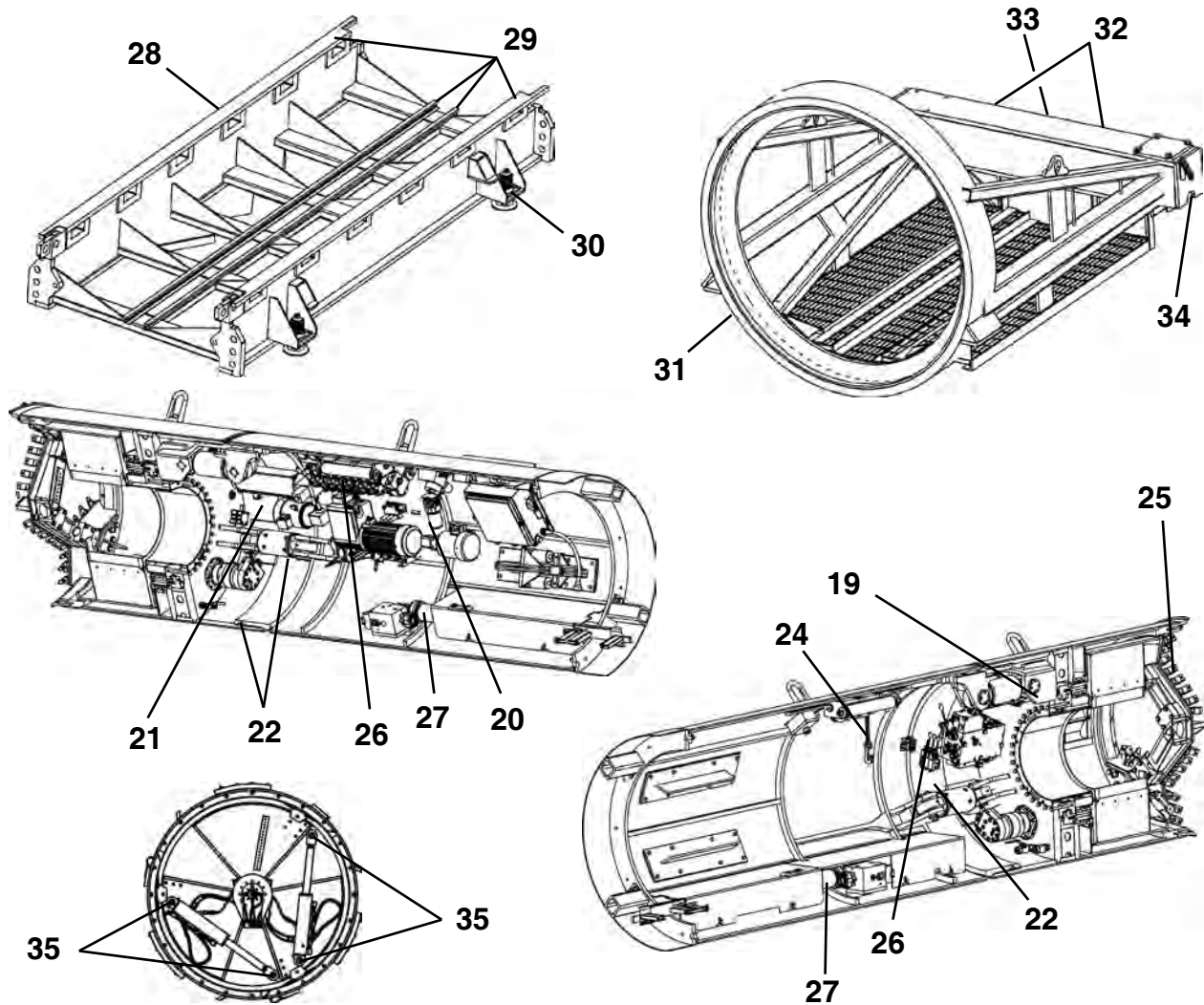

DAILY OR EVERY 10 HOURS OF OPERATION OR SHIFT CHANGE

ITEM	COMPONENT	SERVICE	REQUIREMENT	MATERIAL
19.	Bearing Cavity Oil	Check Oil Level	Oil must be visible at sight gauge.	Mobil 600 XP 460
20.	Bearing Oil Filter	Check Filter	Replace filter per indicator.	
21.	Seal Grease Reservoir	Check Grease Reservoir Level	Fill as needed.	Mobil SHC Grse 101 EAL
22.	Steering Joint	Lubricate (3 places)	Lubricate until grease is forced out.	Mobil XHP222
*23.	Hoses/Pwr Cables	Inspect	Replace if damaged before operating.	
24.	Conveyor Lift Cable	Inspect	Replace at first sign of wear or damage.	
25.	Cutter Bar & Teeth	Inspect & Adjust	Adjust over cut and replace worn or damaged teeth.	
26.	Controls	Check For Proper Operation		
27.	Pressure Filter	Check (2 Filters)	Replace filter(s) per indicator.	Filter Element
28.	Skid Base	Inspect	If damaged, repair or replace.	
29.	Rails	Inspect	If damaged, repair or replace.	
30.	Leveling Screws	Lubricate	Lubricate generously.	Mobil XHP222
31.	Yoke Frame	Inspect	If damaged, repair or replace.	
32.	Ram Retaining Pins	Inspect	If damaged, repair or replace.	
33.	Retaining Pin Stop	Inspect	If damaged, repair or replace.	
34.	Yoke Wheels	Lubricate	Lubricate until grease is forced out.	Mobil XHP222
35.	Closed Face Cyl.	Lubricate	Lubricate until grease is forced out.	Mobil XHP222

* Not Shown

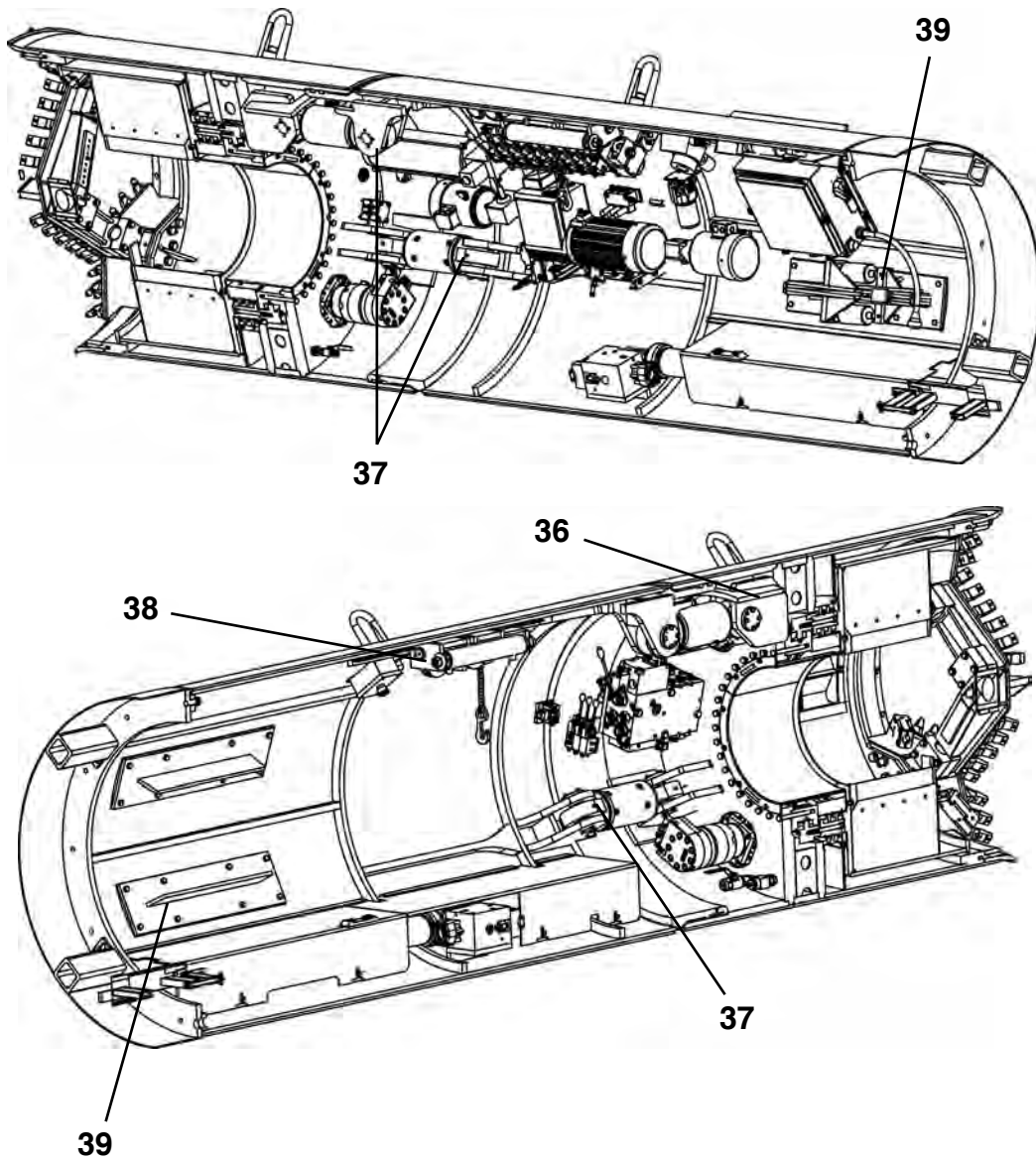

WEEKLY OR EVERY 50 HOURS OF OPERATION

ITEM	COMPONENT	SERVICE	REQUIREMENT	MATERIAL
36.	Bearing Cavity Vent	Check	Clean if necessary.	
37.	Steering Cylinder	Lubricate (2 per cyl)	Lubricate until grease is forced out.	Mobil XHP222
38.	Conveyor Lift	Lubricate (4 places)	Lubricate until grease is forced out.	Mobil XHP222
39.	Dirt/Torque Wing Pins	Lubricate	Lubricate until grease is forced out.	Mobil XHP222

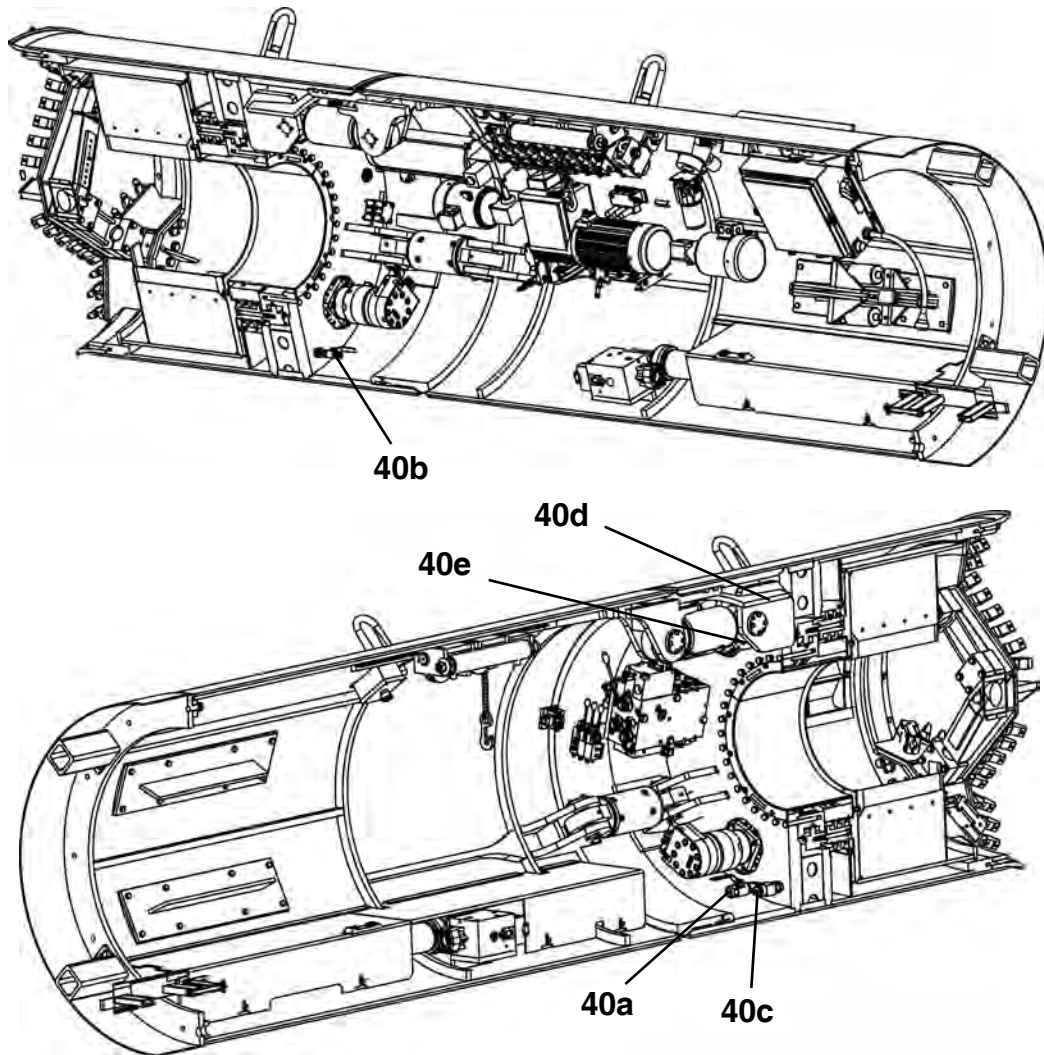

AFTER FIRST DRIVE OR FIRST 100 HOURS OF OPERATION*, THEN MONTHLY OR EVERY 250 HOURS OF OPERATION THEREAFTER

ITEM	COMPONENT	SERVICE	REQUIREMENT	MATERIAL
40.	Bearing Cavity	a. Drain Cavity b. Check Suction Screen c. Inspect Magnet d. Bearing Cavity Vent e. Fill Cavity**	Clean If excessive fragments on magnet contact Akkerman representative. Clean Oil must be visible in sight gauge. ***Approx. 15 - 45 gal (57 -170L)	Mobilgear 600 XP 460

* Whichever occurs first

** Oil change intervals may be increased with periodic examination of oil samples. Any sign of contamination requires the immediate replacement of the bearing cavity oil with new, clean oil.

*** Model dependant

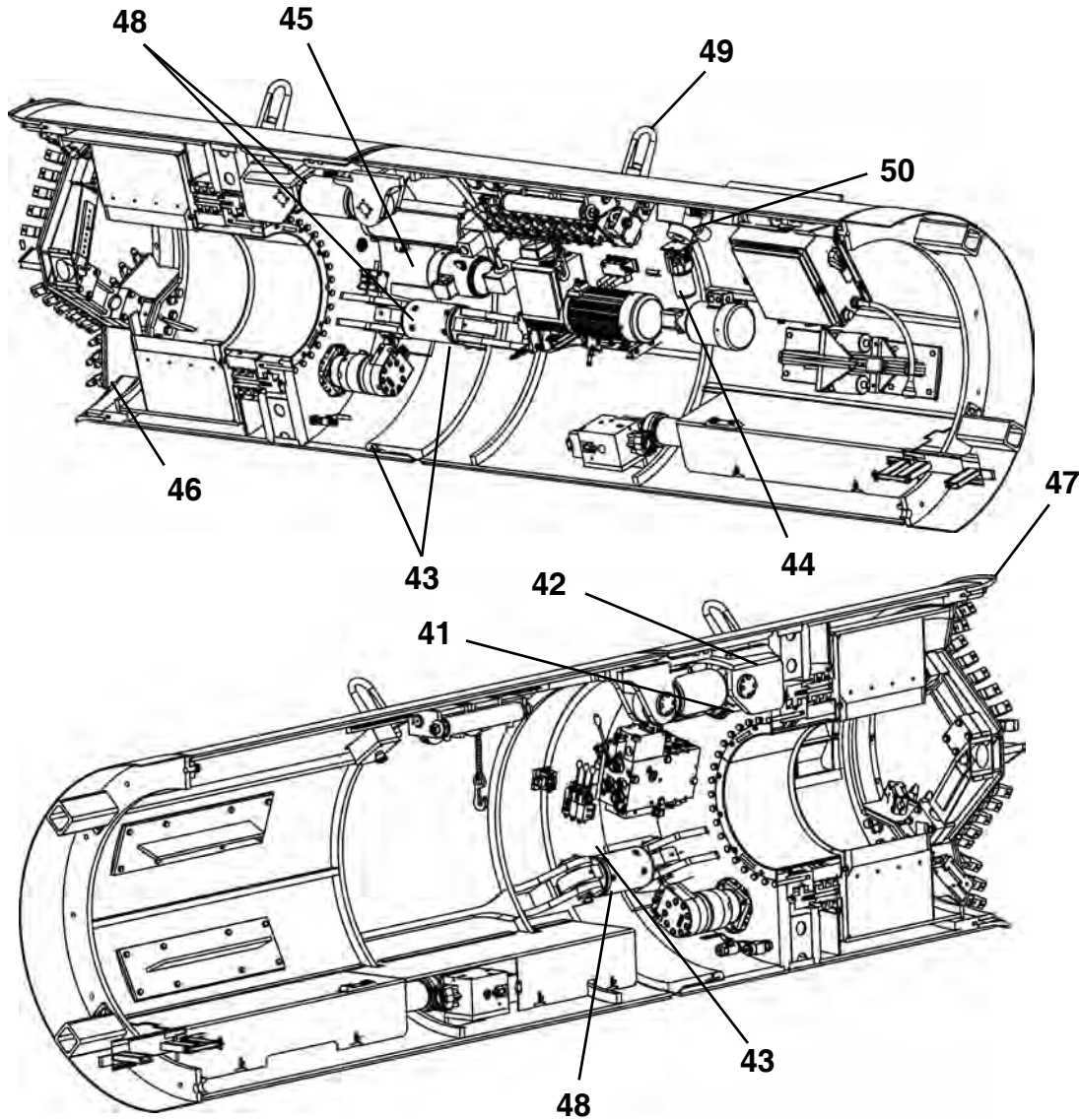

AFTER EACH DRIVE

ITEM	COMPONENT	SERVICE	REQUIREMENT	MATERIAL
41.	Bearing Cavity Oil	Check Oil Level	Oil must be visible on sight gauge.	Mobil Gear 600 XP 460
42.	Bearing Cavity Vent	Check	Clean if necessary.	
43.	Steering Joint	Lubricate (3 places)	Lubricate until grease is forced out.	Mobil XHP222
44.	Bearing Oil Filter	Check Filter	Replace filter per indicator.	
45.	Bearing Seal	Purge Grease	Purge until grease is forced out.	Mobil 101 EAL
46.	Dirt Paddles	Inspect	Replace if damaged.	
47.	Cutter Ring	Inspect For Damage		
48.	Steering Cylinders	Inspect	If damaged, repair or replace.	
49.	Lifting Eye	Inspect	Repair if damaged before lifting.	
50.	Gas Detector	Remove from TBM	Clean and place in storage box.	

PRIOR TO EACH JOB LAUNCH

1. CHECK CONTROL OPERATION

Before launching TBM, be sure to check all TBM, Pump Unit, haul unit controls and other supporting equipment for proper operation. If controls do not function properly, repair or replace BEFORE operation.

CHECK THE FOLLOWING CONTROLS FOR PROPER OPERATION:

- ALL E-Stops, and gas detectors*:
check for proper operation
* refer to your GasMax Instruction Manual for operation and maintenance procedures.
- Conveyor Controls:
conveyor lift - up and down
conveyor drive - forward and reverse
conveyor safety valve switch - MUST stop
cutterhead rotation
- Boring Head Controls:
cutterhead rotation - CW and CCW rotation
- Steering Controls:
steering cylinder - extend and retract
- Dirt Wing Controls
cylinder control - extend and retract
- Auxiliary or Closed Face Controls
check control operation
- Pump Unit Controls
- Haul Unit Controls
- Jacking Frame/IJS Controls
- Lights

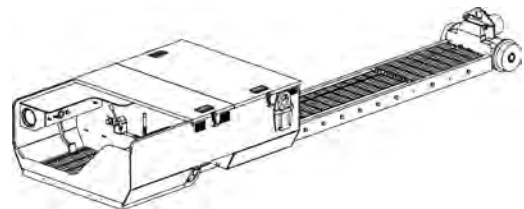
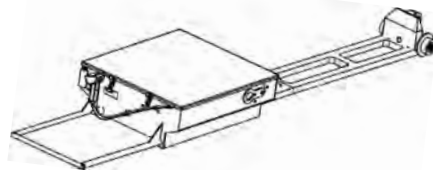
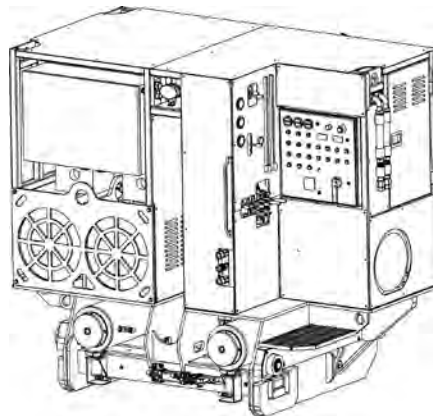
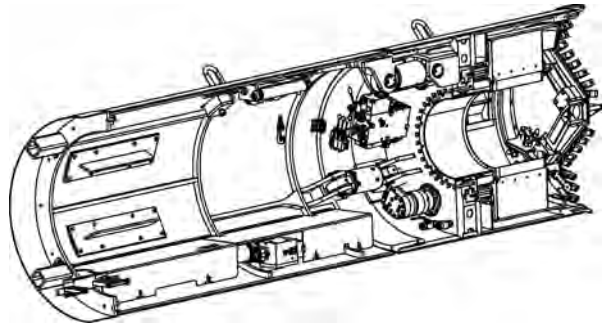

2. CHECK GAUGE OPERATION

Check system pressures for proper operation. If systems are not functioning properly, repair or replace system components BEFORE operation.

TBM

System pressure* (A) 3,000/5,000 psi
 Boring head (CCW) pressure* (A/B)..3,000/5,000 psi
 Boring head (CW) pressure* (A/C).....3,000/5,000 psi
 Conveyor pressure (A)2,800 - 3,000 psi
 Steering pressure** (D/E/F) 3,000/5,000 psi
 Boring Grease pressure (G)
 minimal (approx 500 psi)

* Based on hydraulic supply flow source 3,000/5,000 psi

** The Steering PSI gauges show the active pressure in the cylinders. Pressures may exceed 3,000 psi due to high jacking pressure because of hard ground conditions or over advancement by the pump unit operator.

IMPORTANT: During TBM advancement, DO NOT EXCEED the maximum rated steering cylinder pressure (see below). Doing so will cause hydraulic component, main bearing and structural damage.

48SC 4,500 PSI	420 5,000 PSI
480 4,400 PSI	5404,200 PSI
600 5,000 PSI	6604,100 PSI
720 4,800 PSI	7804,100 PSI

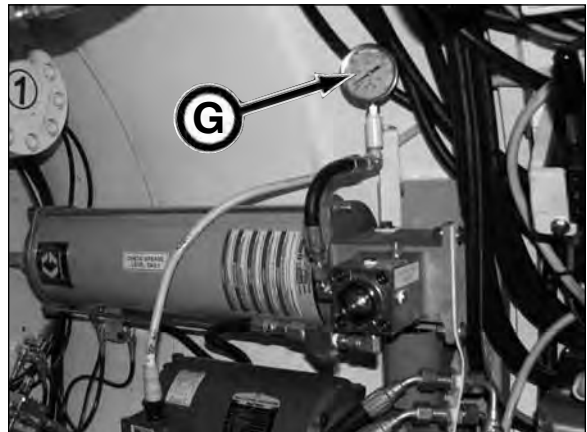
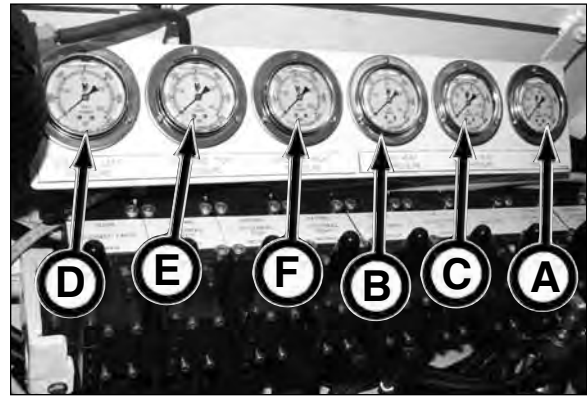

420 Series II

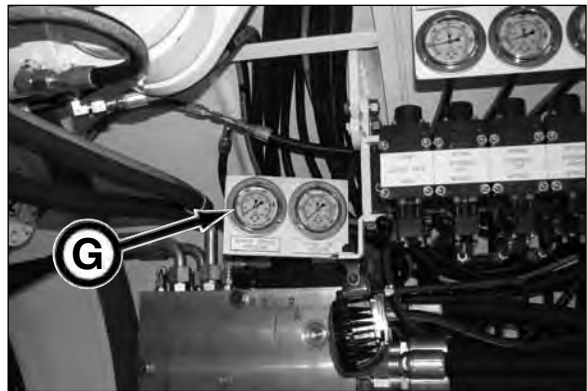

600 Series II

5000 Pump Unit

Boring head pressure* (H) 3,000/5,000 psi
 Auxiliary pressure* (I) 3,000/5,000 psi
 Jacking/IJS high pressure (J) 8,000 psi

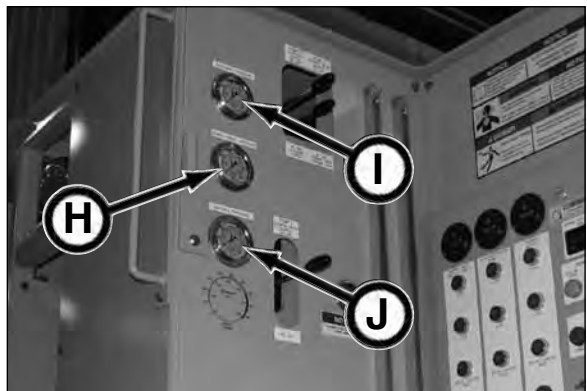

5000 Series II Pump Unit

3. CHECK CUTTER TEETH/SAND SHELVES

Check all cutter teeth or sand shelves. Repair or replace as necessary.

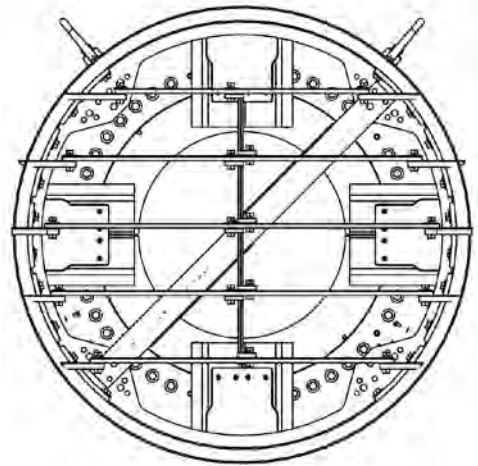
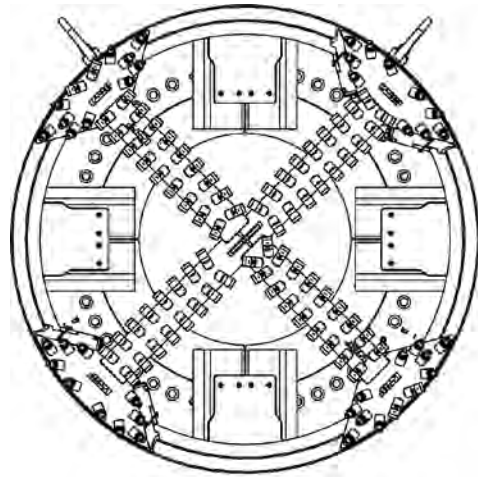

4. CHECK LINE & GRADE

Check line and grade before launching. Adjust as needed using the steering cylinder controls.

Be sure to check line and grade alignment often, with and without forward thrust applied. Keep in mind if you are off one degree, the bore will be off nearly two feet per one hundred feet.



5. LUBRICATE CONVEYOR LIFT

Lubricate conveyor lift with Mobilgrease® XHP222 or equivalent until grease is forced out.

TBM 420 - 540: 4 places
Cable pulley bearing (A) - 4 places

TBM 600 - 780: 7 places
Trolley bracket pins (B) - 4 places
Cable pulley bearing (C) - 2 places
Adjustment pin (D) - 1 place

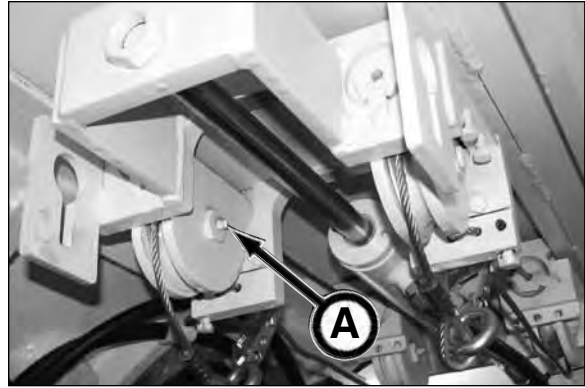

TBM 48SC - 540

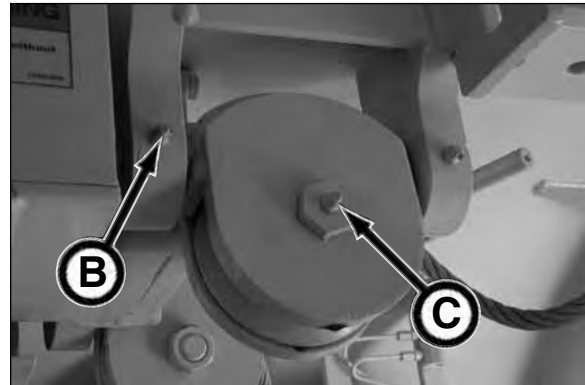

TBM 600 - 780

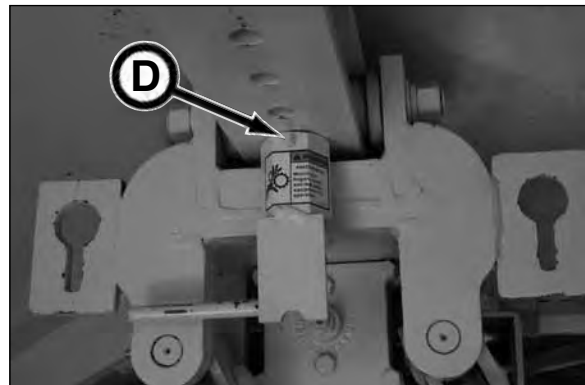

TBM 600 - 780

6. LUBRICATE STEERING CYLINDERS

Lubricate all steering cylinders (A) (2 places per cylinder) with Mobilgrease® XHP222 Premium Lubricating Grease or equivalent until grease is forced out.

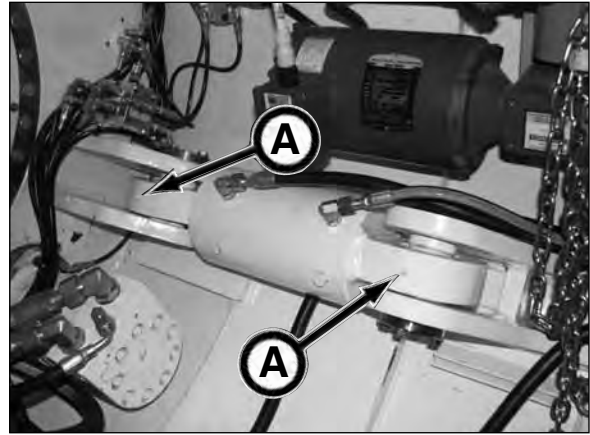

420 Series II

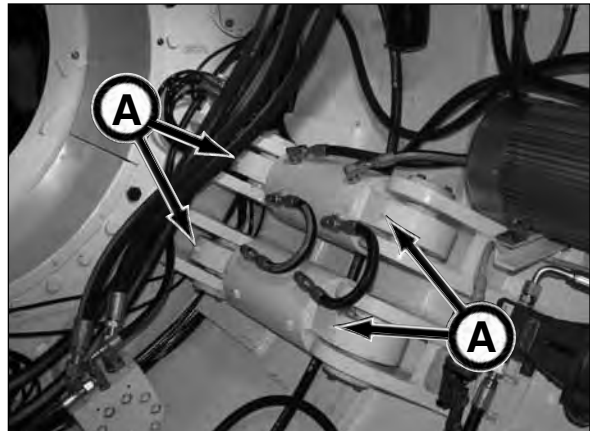

600 Series II

7. LUBRICATE DIRT WING/TORQUE WING PINS

Lubricate all dirt wing/torque wing pins (B) with Mobilgrease® XHP222 Premium Lubricating Grease or equivalent until grease is forced out.

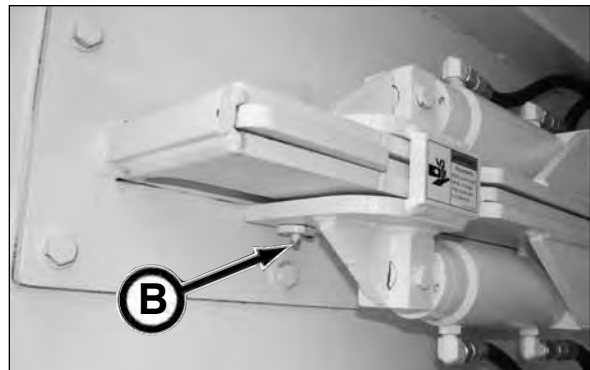

8. LUBRICATE CLOSED FACE CYLINDERS & DOORS (IF EQUIPPED)

Lubricate closed face doors (C) with Mobilgrease® XHP222 or equivalent until grease is forced out.

Lubricate closed face cylinders (D) with Mobilgrease® XHP222 or equivalent until grease is forced out.

The number of cylinders vary depending upon the size of the TBM.

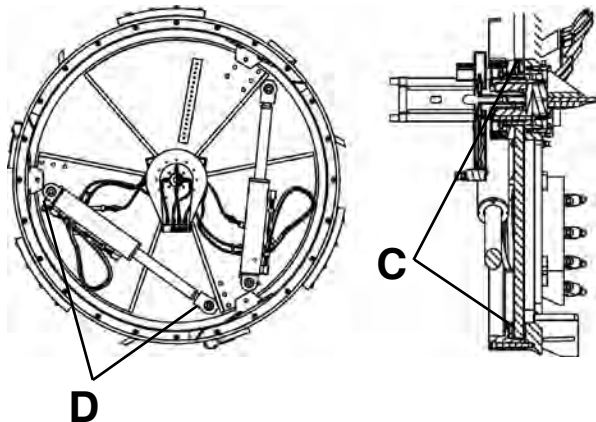

9. CHECK INNER DRUM & BEARING BOLTS

Visually check inner drum (A) and bearing (B) for loose or damaged bolts. If bolt(s) are loose or damaged, contact your Akkerman Aftermarket Support representative **BEFORE** replacing any bolts to the inner drum or bearing.

NOTICE Visually check for loose or damaged bolts only. Checking each bolt torque with a torque wrench may damage the clamp load established from the original torquing of the bolt.

Once approved for replacement, tighten the new bolt M20 x 2.5 Class 10.9 to 350 ft-lb (475 N·m) (lubricated) torque with a properly calibrated torque wrench.

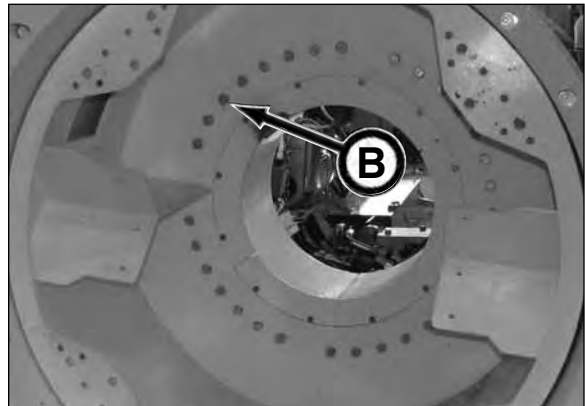
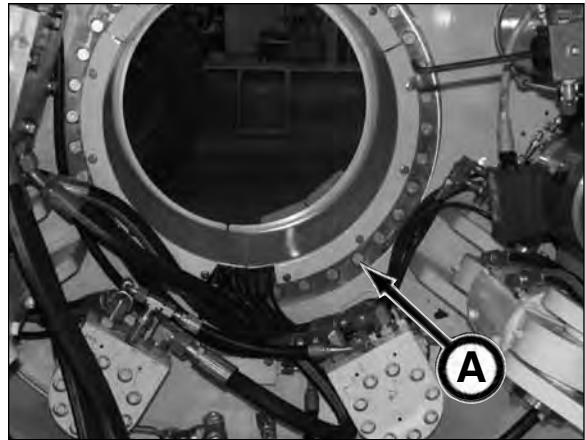

10. CHECK BEARING CAVITY OIL LEVEL

1. Check bearing cavity sight gauge oil level (C). If oil level is not at sight gauge level, add oil in bearing cavity fill port (D) until oil level is at proper level on sight gauge.

2. Replace fill plug.

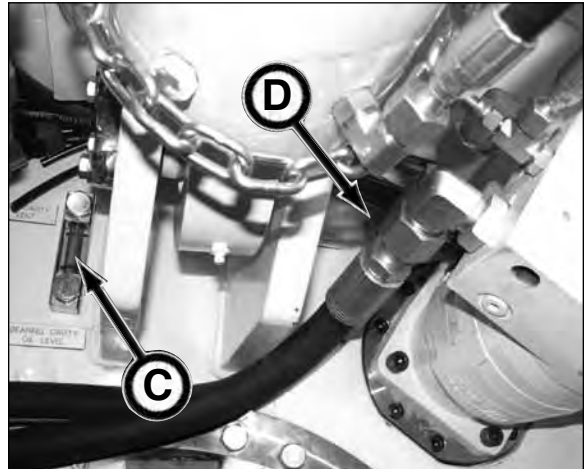

11. CHECK BEARING CAVITY VENT

Check bearing cavity vent (E) for dirt or debris build-up. Clean vent or replace if it shows signs of wear or damage.



12. CHECK BEARING CAVITY OIL FILTER

To prevent under or over servicing of the bearing cavity oil lube filter, a filter indicator (A) is installed on the filter head assembly (B).

A red band will appear on the filter indicator when the filter requires replacement.

NOTICE The red band may display at initial start-up until the oil reaches normal operating temperature. If the red band continues to display after reaching normal operating temperature, replace filter to prevent contamination.

If filter requires replacement, use the following procedure:

1. With power LOCKED OUT, clean and dry area around filter assembly.
2. Close bearing oil cavity shutoff valve (C). This will prevent cavity from draining an excessive amount of lubricant.
3. Remove filter housing (D) from filter head using an oil filter wrench.
4. Remove filter from housing and dispose of filter properly.
5. Remove filter o-ring if stuck in filter housing.
6. Install new o-ring with a light coat of clean oil. Check to be sure the o-ring is not twisted and that it is correctly in place.
7. Install new filter until gasket makes contact with filter head.
8. Replace and secure filter housing to filter head assembly using an oil filter wrench.
9. **Open bearing oil cavity shutoff valve (C).**

IMPORTANT: Failure to open bearing oil cavity shutoff valve before operating TBM WILL cause bearing and bearing lube circuit component damage since the bearing oil will not be recirculating.

10. Check for leaks.

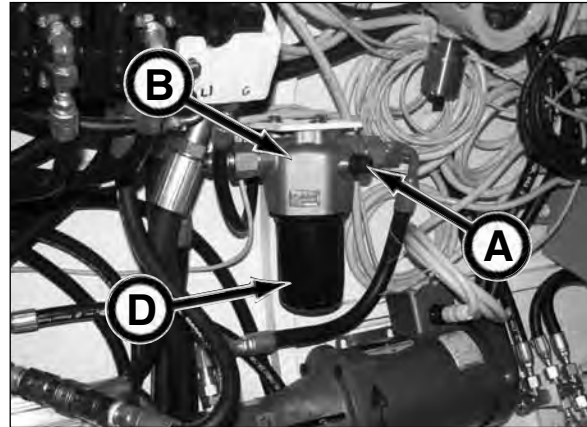

420 Series II

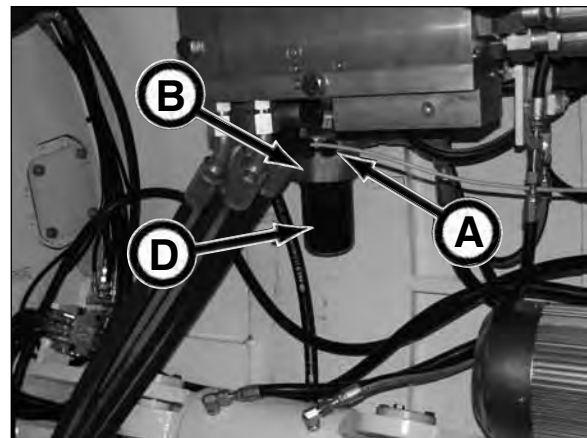

600 Series II



13. CHECK SEAL GREASE RESERVOIR

Check seal grease reservoir (A) to be sure it is full of grease before launching machine:

Check grease level indicator (B). If needed, add Mobil® SHC 101 EAL Grease through grease fill fitting (C) until the grease level indicator reaches the full mark. Be sure to clean debris from grease fill fitting before installing grease gun to fitting to prevent damage to bearing seals.

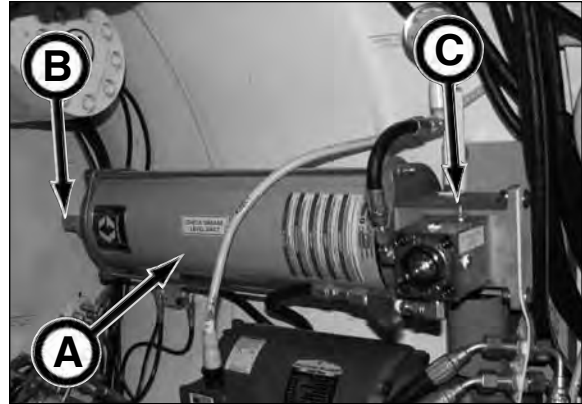

420 Series II

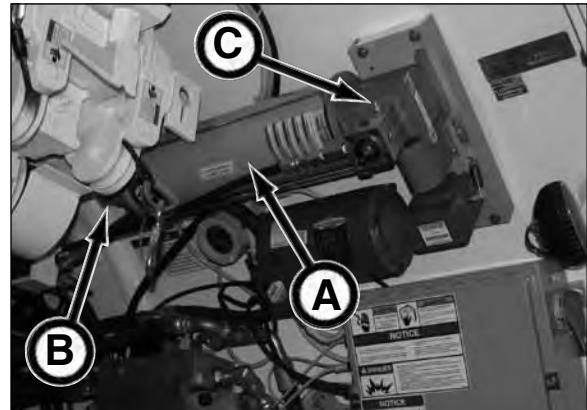

600 Series II

14. CHECK PRESSURE FILTER INDICATORS

To prevent under or over servicing of the pressure filter elements, a filter indicator (D) is installed on each filter assembly (E). There are **two** pressure filter assemblies installed on your TBM and depending on model, are located either under the floor assemblies or are on the right side of the TBM.

When the filter indicator displays a green band, the filters are functioning properly.

When the filter indicator displays a red band, the filter requires replacement.

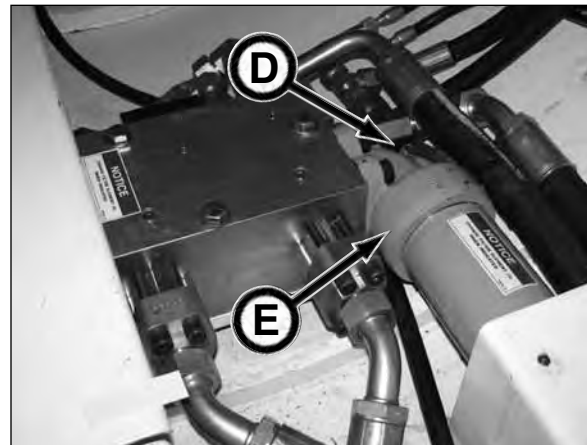

420 Series II

NOTICE The filter indicator may display a red band at initial start-up until the oil reaches normal operating temperature. If the indicator continues to display the red band after reaching normal operating temperature, replace filter to prevent contamination. Both filters require replacement if any of the following situations occur:

- A major component fails.
- Any sign of water contamination from an oil analysis or if oil is milky or foaming.
- A hydraulic oil sample indicates large particle contamination.

(continued on next page)

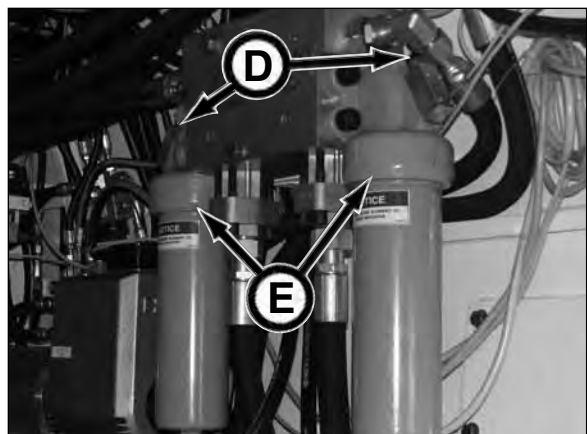

600 Series II

1. With power in LOCKOUT/TAGOUT, clean and dry area around filter(s).
2. (48SC - 420 - 480 - 540) Remove floor panels to access complete filter assembly and housing.



420 Series II

3. Place a properly sized catch pan under filter to minimize the oil spillage in TBM.



600 Series II

4. Unscrew housing (A) from filter head assembly (B).
5. Remove filter element (C) and recycle or dispose of filter and waste oil properly.
6. Carefully install new filter into head assembly until filter is firmly seated into head assembly.
7. Check back-ring (D) and o-ring (E) on housing to be sure it is correctly in place. If back-ring or o-ring are twisted, worn or damaged, they must be replaced.
8. Lightly coat back-ring and o-ring with clean hydraulic oil.
9. Clean threads (F) on housing.
10. Carefully reinstall housing over filter and head assembly until no threads are visible.
11. Check for leaks.
12. Wipe up excess oil in TBM. Recycle or dispose of waste oil properly.
13. If necessary, replace filter on other filter assembly.
14. (48SC - 420 - 480 - 540) Replace floor panels.

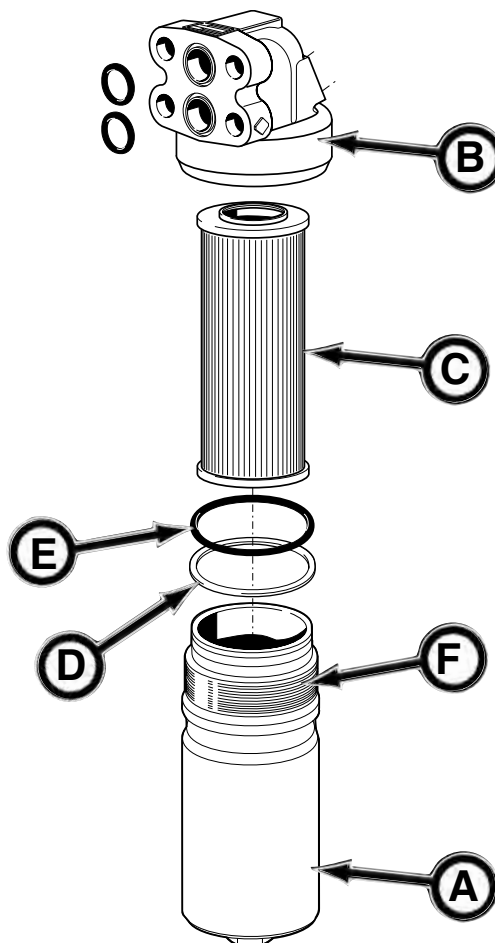

15. LUBRICATE STEERING JOINT

Lubricate steering joint lubrication fittings (A) (3 places) with Mobilgrease® XHP222 Premium Lubricating Grease or equivalent until grease is forced out.

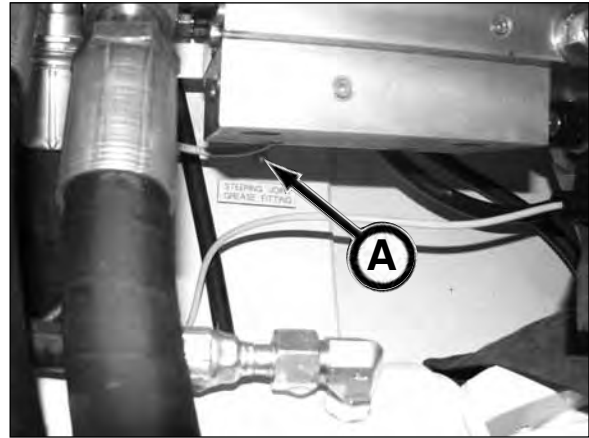

420 Series II

The steering joint lubrication fittings are located at the following positions:
3 o'clock (B), 6 o'clock (C) and 9 o'clock (D).

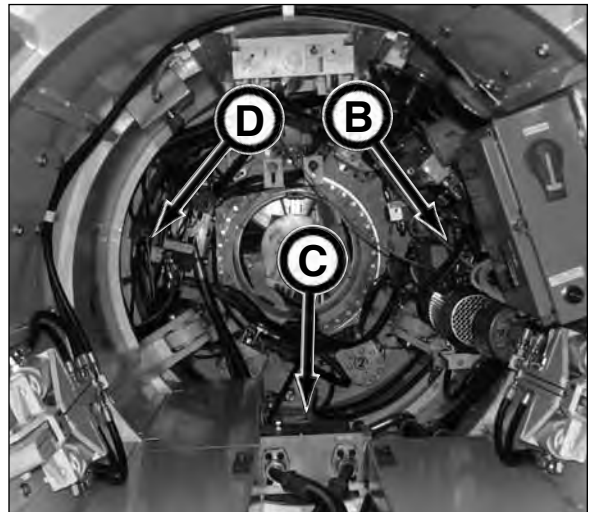

420 Series II

16. INSPECT HYDRAULIC HOSES & POWER CABLES

Inspect ALL hydraulic hoses and power cables for wear or damage. Repair or replace BEFORE operation.



17. INSPECT DECALS

Inspect ALL decals, operational and safety decals to be sure they are clean and readable.

Use soft cloth, water, and a mild soap to clean the decals if they are too dirty to read. DO NOT clean safety decals with solvent. Solvent will damage decals. Replace decals immediately if they are damaged, missing, or hard to read.

Before applying a new decal, be sure the surface is clean and dry.



18. PERFORM MAINTENANCE ON ALL SUPPORTING EQUIPMENT

Be sure all TBM supporting equipment such as the haul unit, pump unit, jacking frame, and generator are properly maintained and are operating properly. Be sure to repair or replace equipment before operating TBM. Refer to the operation and maintenance manuals of the equipment.

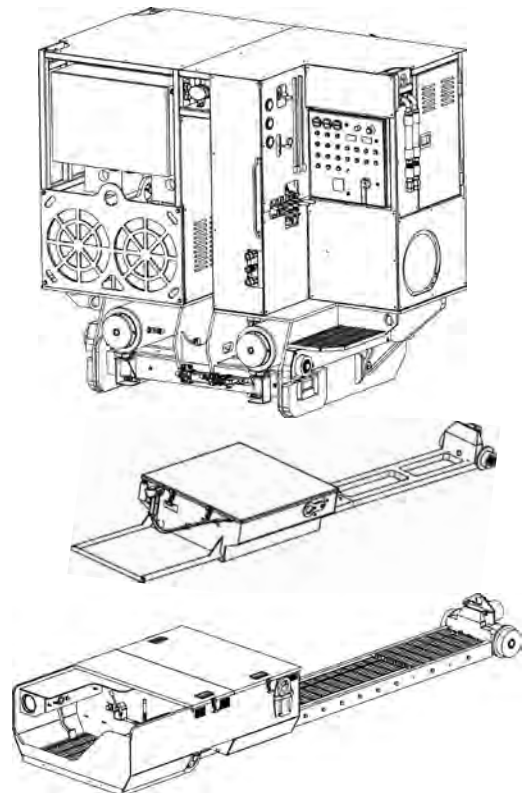

DAILY OR EVERY 10 HOURS OF OPERATION OR SHIFT CHANGE

19. CHECK BEARING CAVITY OIL LEVEL

1. Check bearing cavity sight gauge oil level (A).
If oil level is not at sight gauge level, add oil in bearing cavity fill port (B) until oil level is at proper level on sight gauge.
2. Replace fill plug.

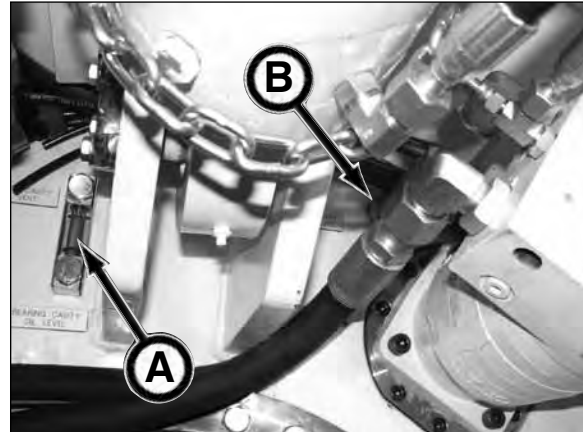

20. CHECK BEARING CAVITY OIL FILTER

To prevent under or over servicing of the bearing cavity oil lube filter, a filter indicator (C) is installed on the filter head assembly (D).

A red band will appear when the filter requires replacement.

NOTICE

The red band may display at initial start-up until the oil reaches normal operating temperature. If the red band continues to display after reaching normal operating temperature, replace filter to prevent contamination.

If filter requires replacement, use the following procedure:

1. With power LOCKED OUT, clean and dry area around filter assembly.
2. Close bearing oil cavity shutoff valve (E). This will prevent cavity from draining an excessive amount of lubricant.
3. Remove filter housing (F) from filter head using an oil filter wrench.
4. Remove filter from housing and dispose of filter properly.
5. Remove filter o-ring if stuck in filter housing.
6. Install new o-ring with a light coat of clean oil. Check to be sure the o-ring is not twisted and that it is correctly in place.
7. Install new filter until gasket makes contact with filter head.
8. Replace and secure filter housing to filter head assembly using an oil filter wrench.
9. **Open bearing oil cavity shutoff valve (E).**

IMPORTANT: Failure to open bearing oil cavity shutoff valve before operating TBM WILL cause bearing and bearing lube circuit component damage since the bearing oil will not be recirculating.

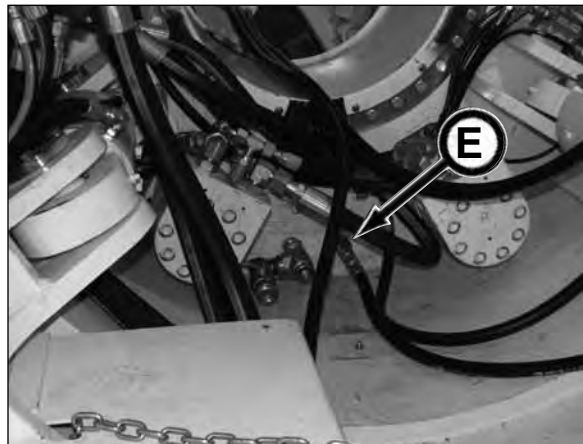
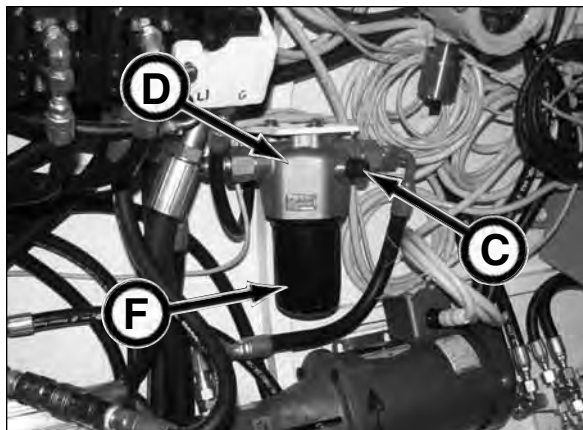

21. CHECK SEAL GREASE RESERVOIR

Check seal grease reservoir (A) to be sure it is full of grease before launching machine:

Check grease level indicator (B). If needed, add Mobil® SHC 101 EAL Grease through grease fill fitting (C) until the grease level indicator reaches the full mark. Be sure to clean debris from grease fill fitting before installing grease gun to fitting to prevent damage to bearing seals.

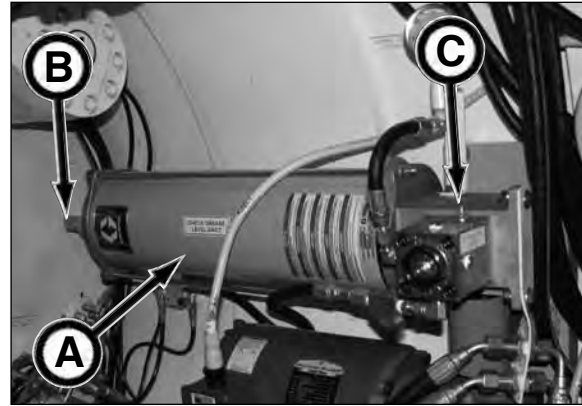

420 Series II

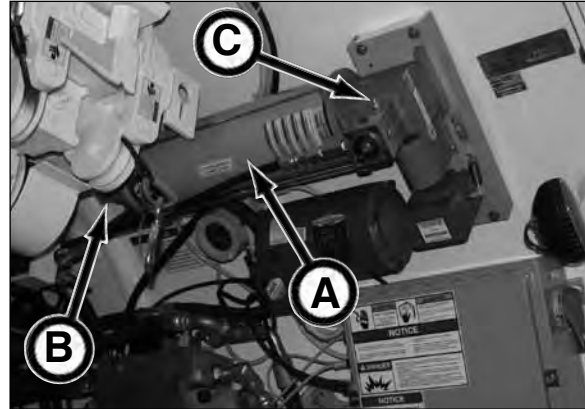

600 Series II

22. LUBRICATE STEERING JOINT

Lubricate steering joint lubrication fittings (D) (3 places) with Mobilgrease® XHP222 Premium Lubricating Grease or equivalent until grease is forced out.

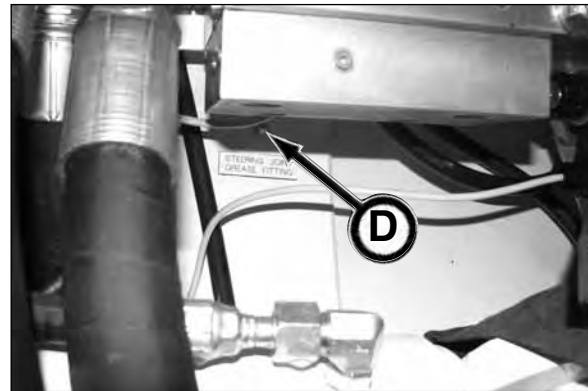

420 Series II

The steering joint lubrication fittings are located at the following positions:
3 o'clock (E), 6 o'clock (F) and 9 o'clock (G).

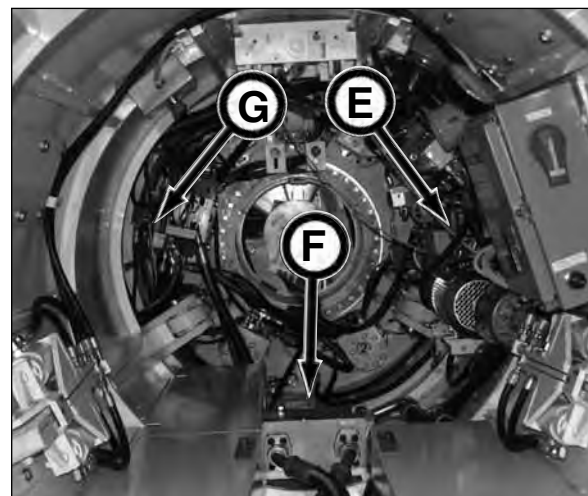

420 Series II

23. INSPECT HYDRAULIC HOSES & POWER CABLES

Inspect ALL hydraulic hoses and power cables for wear or damage. Repair or replace BEFORE operation.



24. INSPECT CONVEYOR LIFT CABLES

Inspect conveyor lift cables, hooks, protective sleeves and cable clamps (A) for wear or damage.

Replace cables, hooks, protective sleeves and cable connectors as a set at the first sign of wear or damage.

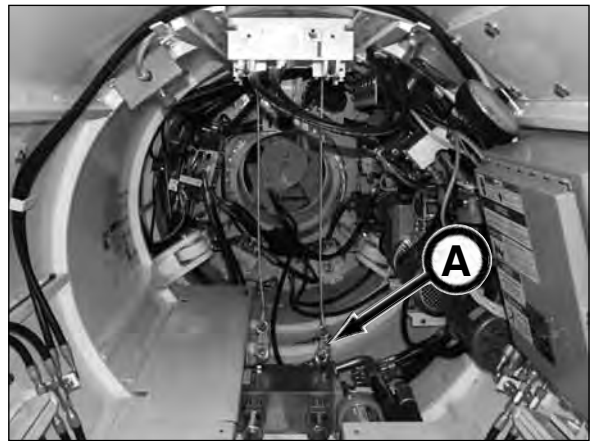

25. INSPECT CUTTER BAR/TEETH OR SAND SHELVES

Inspect cutter bar, teeth, and/or sand shelves for wear or damage. Repair or replace as needed.

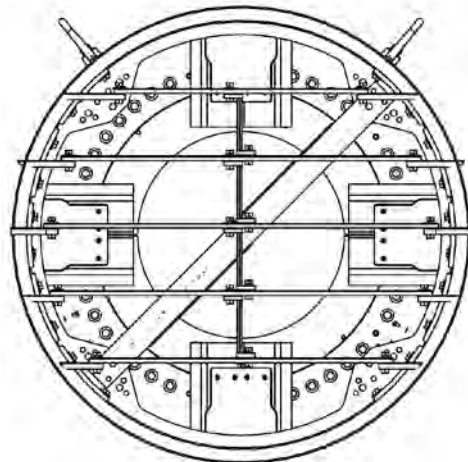
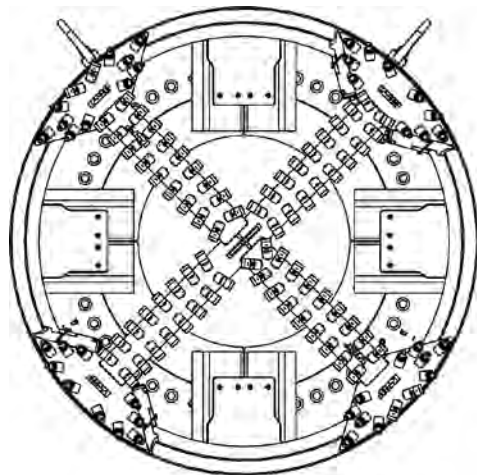

27. CHECK PRESSURE FILTER INDICATORS

To prevent under or over servicing of the pressure filter elements, a filter indicator (A) is installed on each filter assembly (B). There are **two** pressure filter assemblies installed on your TBM and are located under the floor assemblies.

When the filter indicator displays a green band, the filters are functioning properly.

When the filter indicator displays a red band, the filter requires replacement.

NOTICE The filter indicator may display a red band at initial start-up until the oil reaches normal operating temperature. If the indicator continues to display the red band after reaching normal operating temperature, replace filter to prevent contamination. Both filters require replacement if any of the following situations occur:

- A major component fails.
- Any sign of water contamination from an oil analysis or if oil is milky or foaming.
- A hydraulic oil sample indicates large particle contamination.

1. With power in LOCKOUT/TAGOUT, clean and dry area around filter(s).
2. (48SC - 420 - 480 - 540) Remove floor panels to access complete filter assembly and housing.
3. Place a properly sized catch pan under filter to minimize the oil spillage in TBM.

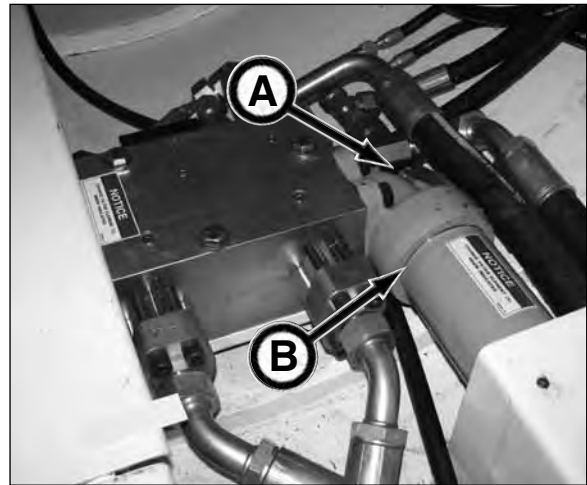

420 Series II

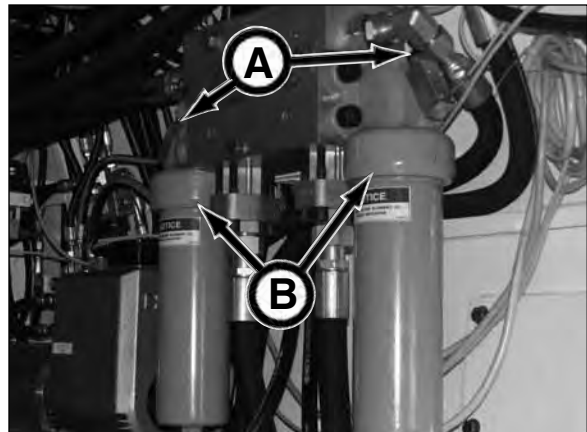

600 Series II



420 Series II



600 Series II

4. Unscrew housing (A) from filter head assembly (B).
5. Remove filter element (C) and recycle or dispose of filter and waste oil properly.
6. Carefully install new filter into head assembly until filter is firmly seated into head assembly.
7. Check back-ring (D) and o-ring (E) on housing to be sure it is correctly in place. If back-ring or o-ring are twisted, worn or damaged, they must be replaced.
8. Lightly coat back-ring and o-ring with clean hydraulic oil.
9. Clean threads (F) on housing.
10. Carefully reinstall housing over filter and head assembly until no threads are visible.
11. Check for leaks.
12. Wipe up excess oil in TBM. Recycle or dispose of waste oil properly.
13. If necessary, replace filter on other filter assembly.
14. (420 - 540) Replace floor panels.

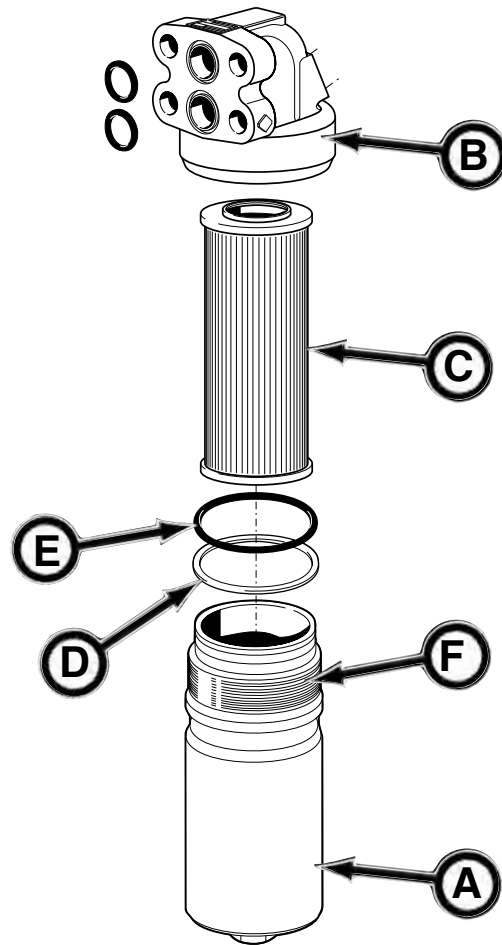

28. INSPECT SKID BASE

Visually inspect skid base for cracks or other damage. Also check for damaged, loose, or missing hardware. Replace with new.

If cracks or damage are present, contact your Akkerman Aftermarket Support representative for authorized repair or replacement procedures.

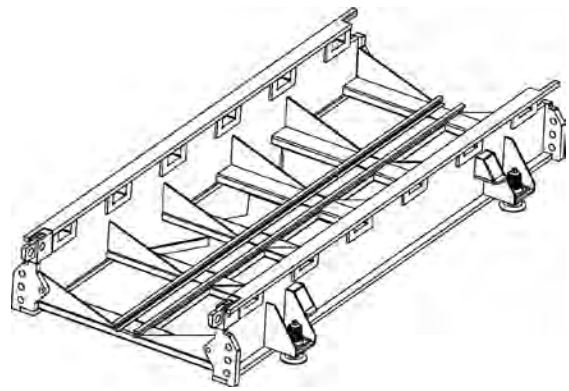

29. INSPECT RAILS

Clean and inspect rails (A) for cracks or other damage.

If cracks or damage are present, contact your Akkerman Aftermarket Support representative for authorized repair or replacement procedures.

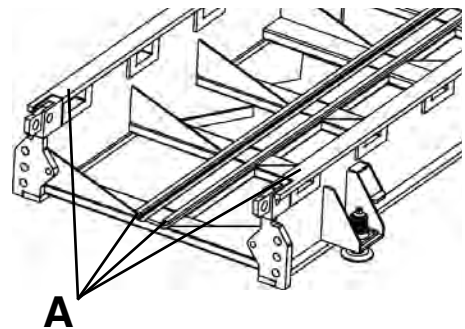

30. LUBRICATE LEVELING SCREWS

Lubricate leveling screws (B) with Mobilgrease® XHP222 Premium Lubricating Grease or equivalent.

Lubricate threads thoroughly.

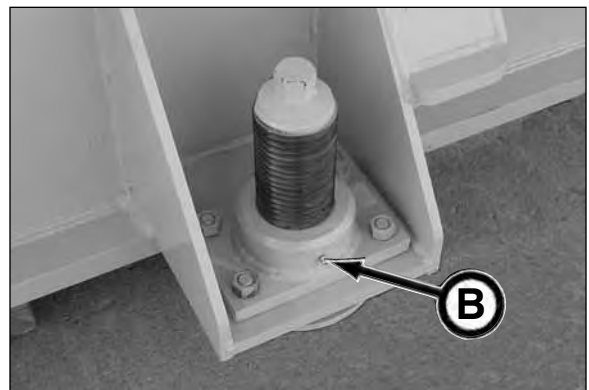

31. INSPECT YOKE FRAME

Visually inspect yoke for cracks or other damage. Also check for damaged, loose, or missing hardware. Replace with new.

If cracks or damage are present, contact your Akkerman Aftermarket Support representative for authorized repair or replacement procedures.

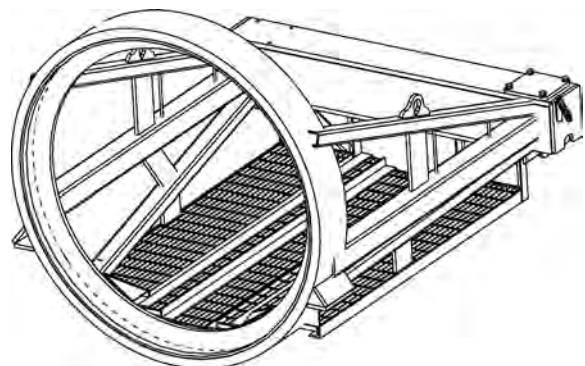

32. INSPECT RAM RETAINING PINS

Visually inspect retaining pins (A) (2 places) for damage.

If damage is present, replace with new.

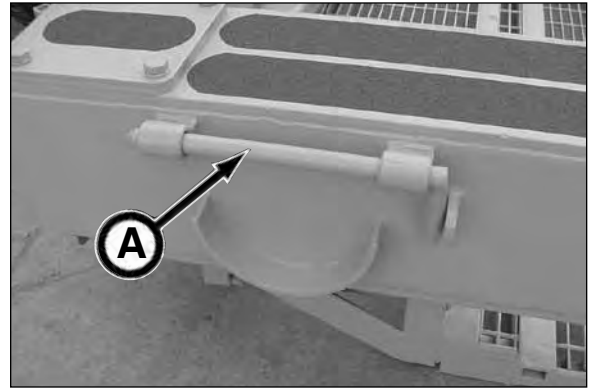

33. INSPECT RAM RETAINING PIN STOP

Visually inspect stop (B) or hardware for damage.

If damaged or missing, replace with new.

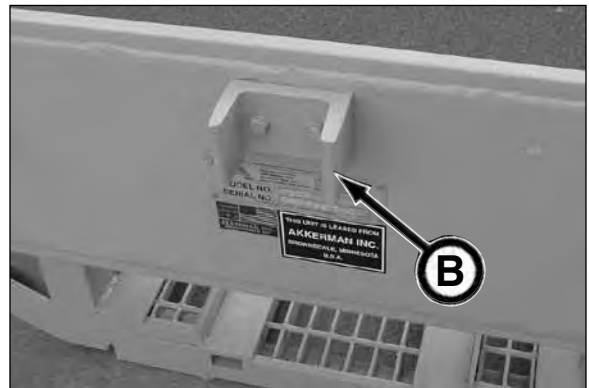

34. LUBRICATE YOKE WHEELS

Lubricate yoke wheels (C) with Mobilgrease® XHP222 Premium Lubricating Grease or equivalent.

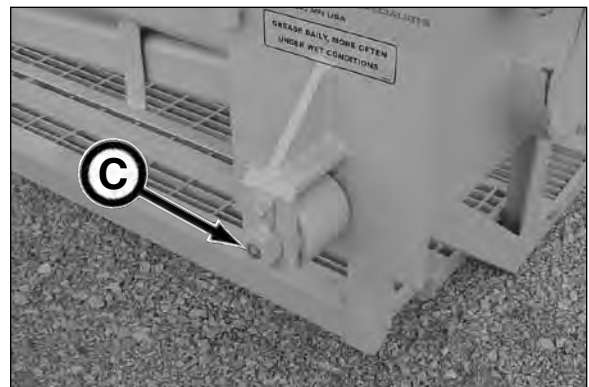

35. LUBRICATE CLOSED FACE CYLINDERS (IF EQUIPPED)

Lubricate closed face cylinders (D) with Mobilgrease® XHP222 or equivalent until grease is forced out.

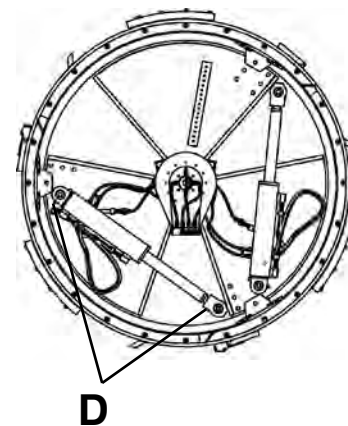

WEEKLY OR EVERY 50 HOURS OF OPERATION

36. CHECK BEARING CAVITY VENT

Check bearing cavity vent (A) for dirt or debris build-up. Clean vent or replace if it shows signs of wear or damage.



420 Series II

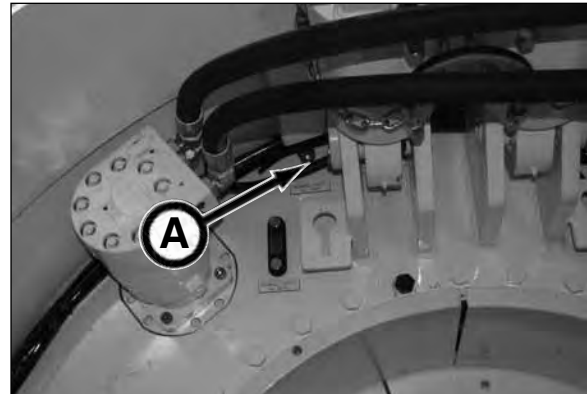

600 Series II

37. LUBRICATE STEERING CYLINDERS

Lubricate all steering cylinder lubrication fittings (B) (2 places per cylinder) with Mobilgrease® XHP222 Premium Lubricating Grease or equivalent until grease is forced out.

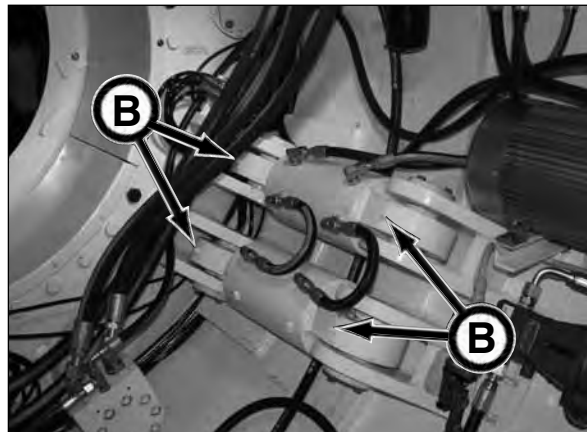

600 Series II

Steering Cylinders:
Left (C)
Center (D)
Right (E)

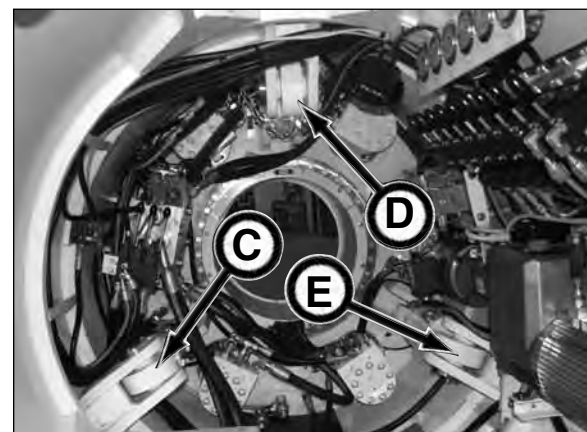

420 Series II

38. LUBRICATE CONVEYOR LIFT

Lubricate conveyor lift with Mobilgrease® XHP222 or equivalent until grease is forced out.

TBM 48SC - 420 - 480 - 540: 4 places
Cable pulley bearing (A) - 4 places

TBM 600 - 660 - 720 - 780: 7 places
Trolley bracket pins (B) - 4 places
Cable pulley bearing (C) - 2 places
Adjustment pin (D) - 1 place

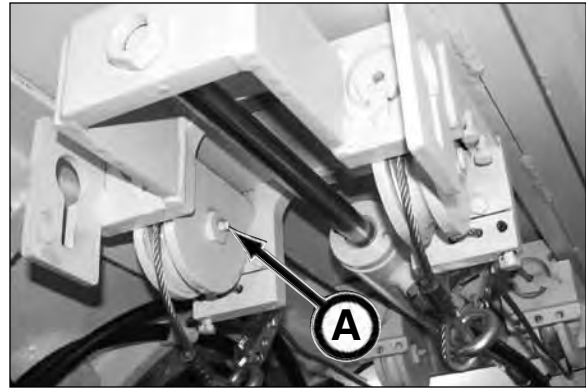

TBM 48SC - 420 - 480 - 540

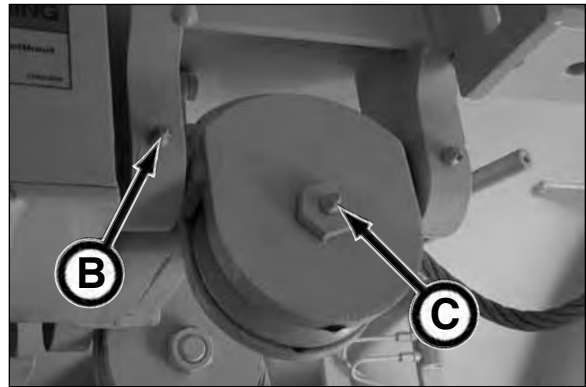

TBM 600 - 660 - 720 - 780

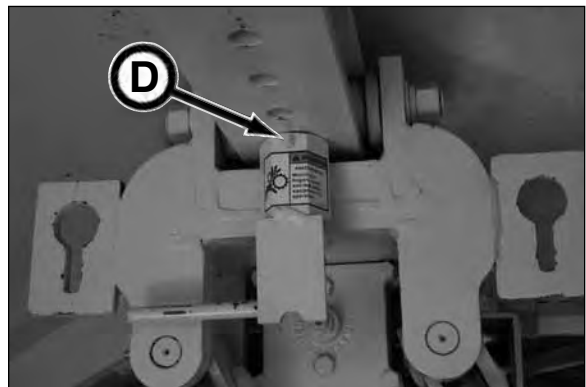

TBM 600 - 660 - 720 - 780

39. LUBRICATE DIRT WING/TORQUE WING PINS

Lubricate all dirt wing/torque wing pins (E) with Mobilgrease® XHP222 Premium Lubricating Grease or equivalent until grease is forced out.

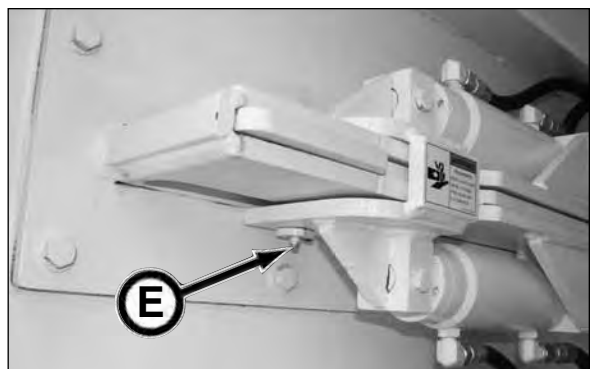

AFTER FIRST DRIVE OR FIRST 100 HOURS OF OPERATION*, THEN MONTHLY OR EVERY 250 HOURS OF OPERATION THEREAFTER

40. PERFORM BEARING CAVITY MAINTENANCE

NOTICE Oil change interval may be increased with periodic examination of oil samples. Any sign of contamination requires the immediate replacement of the bearing cavity oil with new, clean oil.

The bearing cavity maintenance consists of:

- draining bearing cavity
- check and clean suction screen
- inspect bearing cavity magnetic rod for fragments
- clean bearing cavity vent
- fill bearing cavity with new, fresh oil.

* Whichever occurs first.

Perform bearing cavity maintenance as follows:

1. Clean area around bearing cavity oil fill port (A) and bearing cavity oil vent (B) to prevent dirt/debris from accidentally entering bearing cavity.
2. Remove fill plug and retain for later reinstallation.

3. Clean area around bearing oil drain shutoff valve (C) and magnetic rod valve (D).

(continued on next page)

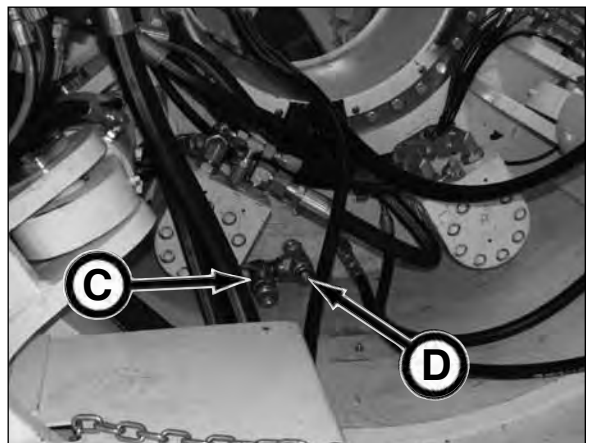
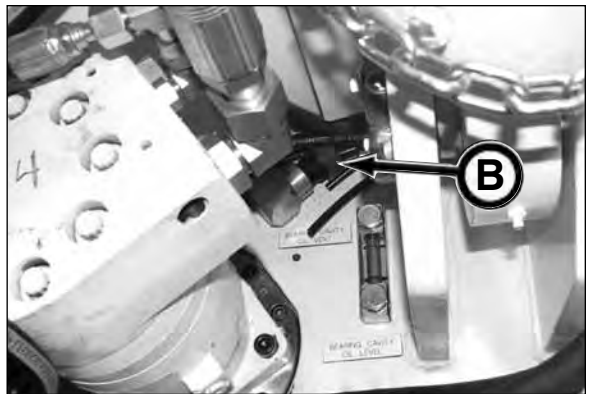
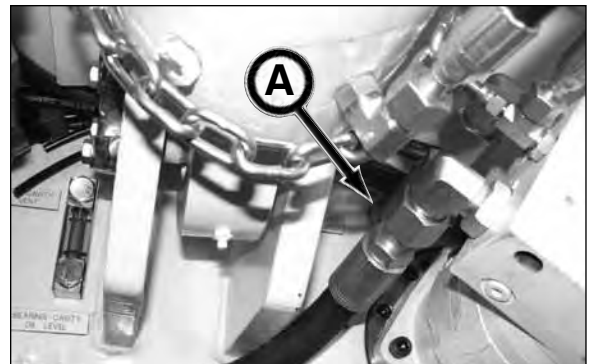
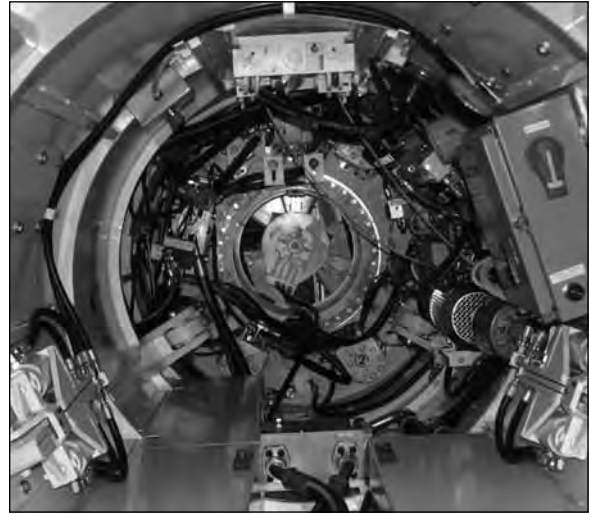

4. Remove drain plug (A) and install a hose to shutoff valve. Route hose to a properly sized container for draining the oil from the bearing cavity.
5. Open bearing oil drain shutoff valve and drain oil into container until bearing cavity is drained.

NOTICE If possible, carefully rotate TBM to drain additional oil from bearing cavity.

6. Remove magnetic rod/plug (B). Inspect rod for metal fragments. If fragments appear to be excessive, contact your Akkerman Aftermarket Support representative for information on how to resolve this issue.

7. Clean rod and replace magnetic rod valve plug.

8. Clean area around bearing cavity oil shutoff valve (C) and suction strainer (D). Close valve.

9. Remove suction strainer/shutoff valve and clean strainer.

10. Replace suction strainer.

11. Open bearing cavity oil shutoff valve.

12. Check bearing cavity vent (E) for dirt or debris build-up. Clean vent or replace if it shows signs of wear or damage.

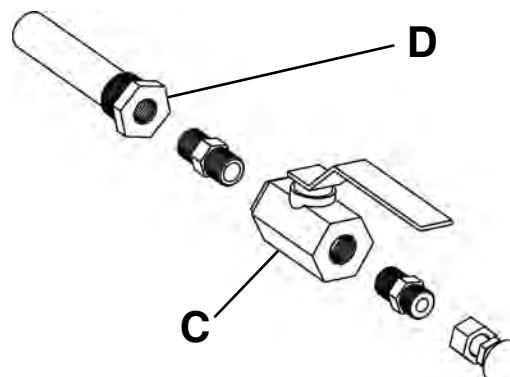
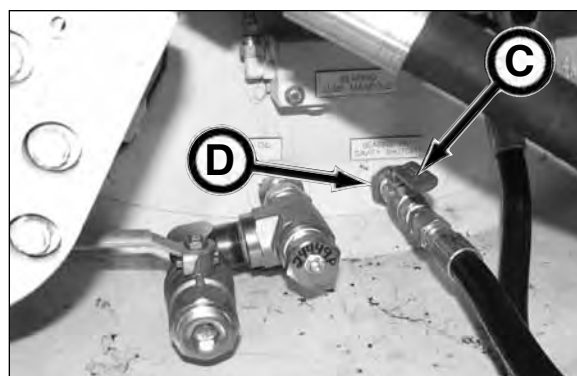
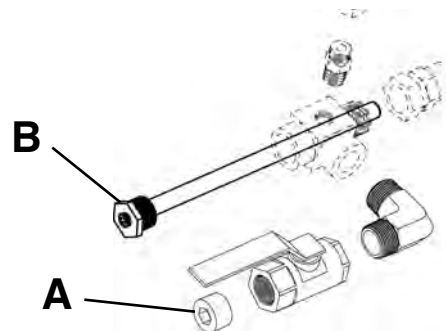
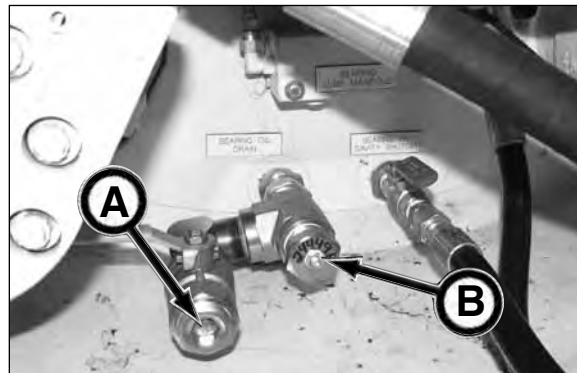

13. Fill the bearing cavity with Mobilgear® 600XP 460 gear oil or equivalent through fill port (A) until the oil level is visible on the sight gauge (B).

Bearing Cavity Oil Capacity (Approximately)
..... 15 - 45 gal (57 - 170 L) depending on
model

14. Replace fill port fitting.

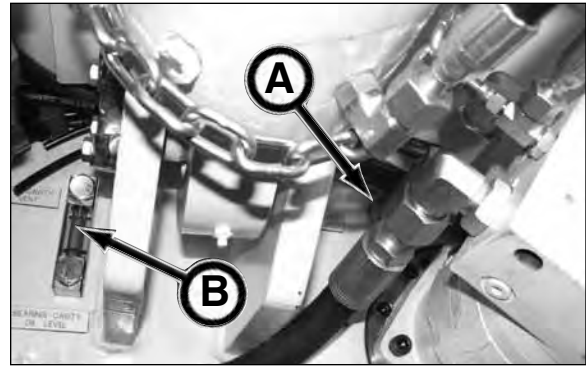

AFTER EACH DRIVE

41. CHECK BEARING CAVITY OIL LEVEL

1. Check bearing cavity sight gauge oil level (A).
If oil level is not at sight gauge level, add oil in bearing cavity fill port (B) until oil level is at proper level on sight gauge.
2. Replace fill port fitting.

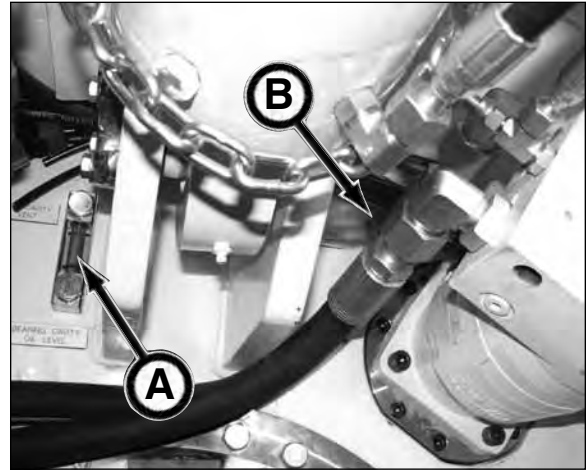

42. CHECK BEARING CAVITY VENT

Check bearing cavity vent (C) for dirt or debris build-up. Clean vent or replace if it shows signs of wear or damage.



43. LUBRICATE STEERING JOINT

Lubricate steering joint lubrication fittings (D) (3 places) with Mobilgrease® XHP222 Premium Lubricating Grease or equivalent until grease is forced out.

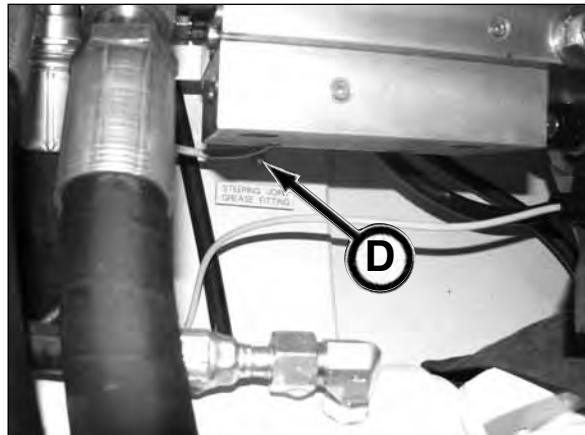

The steering joint lubrication fittings are located at the following positions:
3 o'clock (E), 6 o'clock (F) and 9 o'clock (G).

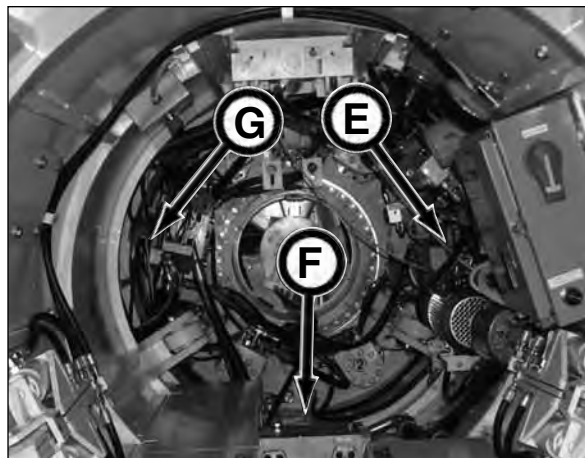

44. CHECK BEARING CAVITY OIL FILTER

To prevent under or over servicing of the bearing cavity oil lube filter, a filter indicator (A) is installed on the filter head assembly (B).

A red band will appear when the filter requires replacement.

NOTICE

The red band may display at initial start-up until the oil reaches normal operating temperature. If the red band continues to display after reaching normal operating temperature, replace filter to prevent contamination.

If filter requires replacement, use the following procedure:

1. With power LOCKED OUT, clean and dry area around filter assembly.
2. Close bearing oil cavity shutoff valve (C). This will prevent cavity from draining an excessive amount of lubricant.
3. Remove filter housing (D) from filter head using an oil filter wrench.
4. Remove filter from housing and dispose of filter properly.
5. Remove filter o-ring if stuck in filter housing.
6. Install new o-ring with a light coat of clean oil. Check to be sure the o-ring is not twisted and that it is correctly in place.
7. Install new filter until gasket makes contact with filter head.
8. Replace and secure filter housing to filter head assembly using an oil filter wrench.
9. **Open bearing oil cavity shutoff valve (C).**

IMPORTANT: Failure to open bearing oil cavity shutoff valve before operating TBM WILL cause bearing and bearing lube circuit component damage since the bearing oil will not be recirculating.

10. Check for leaks.

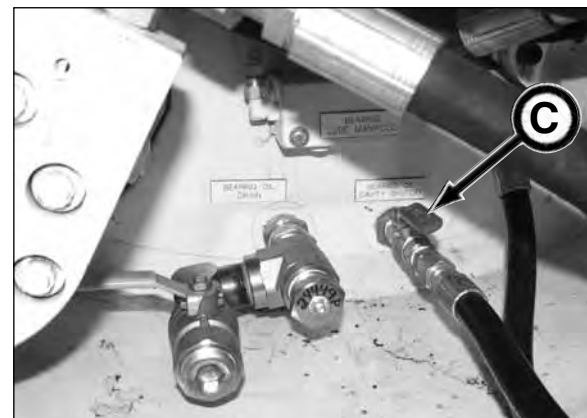
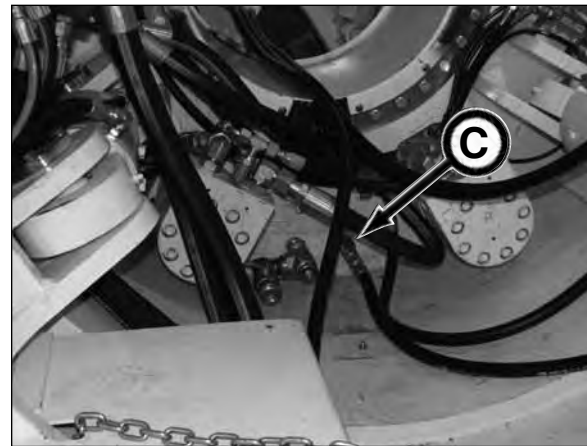
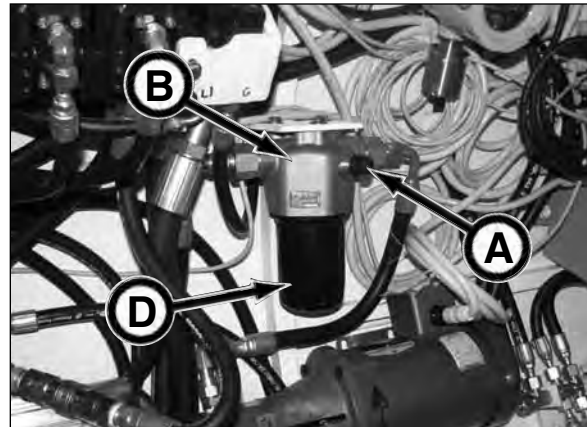

45. PURGE BEARING SEAL GREASE

It is necessary to purge the bearing seals of grease to remove dirt that may have entered the seal area during the drive.

1. Check the seal grease reservoir level indicator (A) to be sure there is an ample amount of grease in the reservoir to purge the bearing seals.



420 Series II

2. Purge the bearing seal grease by rotating the cutter head until fresh, clean grease is visible in the area (B) between the bulkhead adapter plate (C) and bearing guard (D).

NOTICE Be sure to rotate cutter head while purging bearing seal grease. Failure to do so will not properly purge grease from bearing seals.



600 Series II

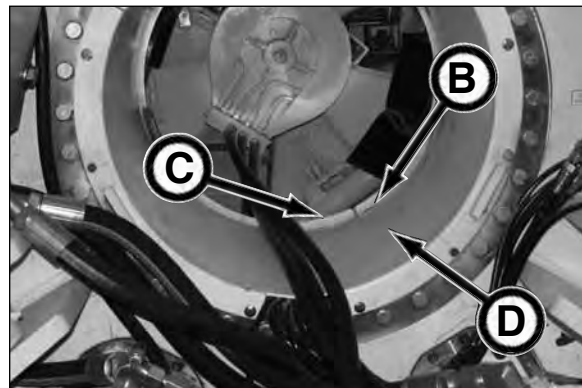

46. INSPECT DIRT PADDLES

Inspect dirt paddles (E) for wear or damage. Replace dirt paddles as needed.

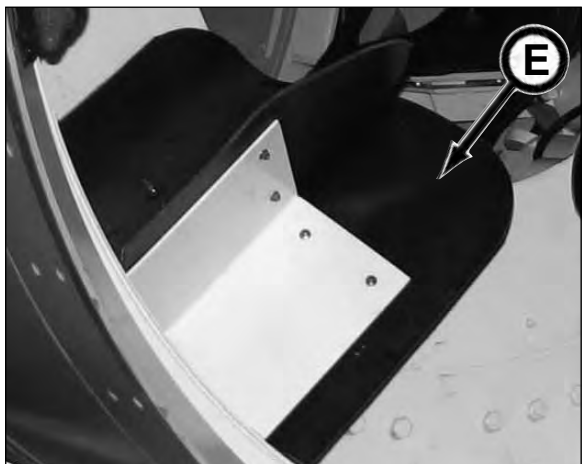

47. INSPECT CUTTER RING

Inspect cutter ring edge (A) for wear or damage. Cutter ring should not be dented, bent or flat. Repair as needed.

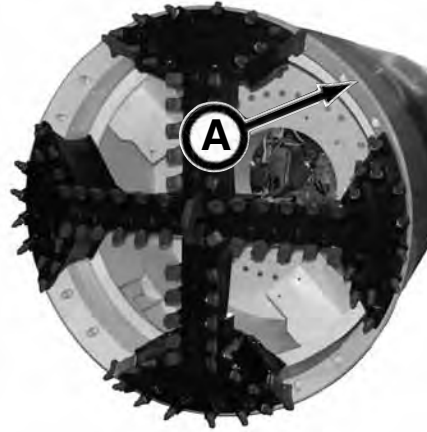

48. INSPECT STEERING CYLINDERS

Inspect steering cylinders for wear or damage. Repair or replace before operating.

Steering Cylinders:
Left (B)
Center (C)
Right (D)

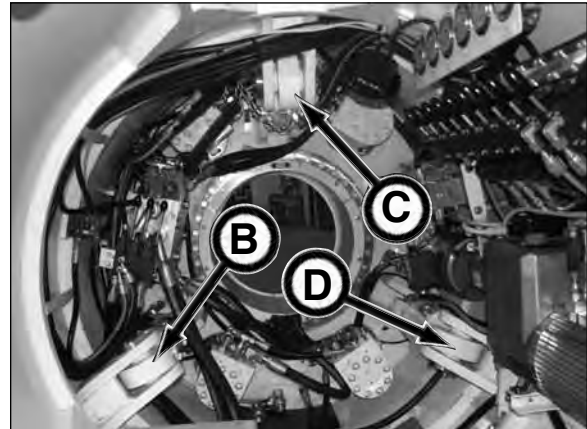

49. INSPECT LIFTING EYES

Inspect lifting eyes (E) for wear or damage. Worn or damaged lifting eyes **MUST** be replaced before lifting.



50. CLEAN & STORE GAS DETECTOR

NOTICE

For more information, refer to your GasMax Instruction Manual.

Once the contractor determines the TBM gas detector is no longer needed in the TBM after the end of the drive:

1. Remove gas detector (F) from TBM.

IMPORTANT: Be careful to not subject sensor to any water or cleaning solution, otherwise sensor will be damaged. Refer to gas detector manual for more maintenance information.

2. Clean display with a mild, abrasive-free cleaning solution and scratch free cloth.
3. Clean housing with a mild cleaning solution and place in a storage box.
4. Place box in a ventilated, preferably climate controlled area.



MAINTENANCE CHARTS - BELT CONVEYOR

Use the item number in the chart to refer to the detailed maintenance procedures later in this section.

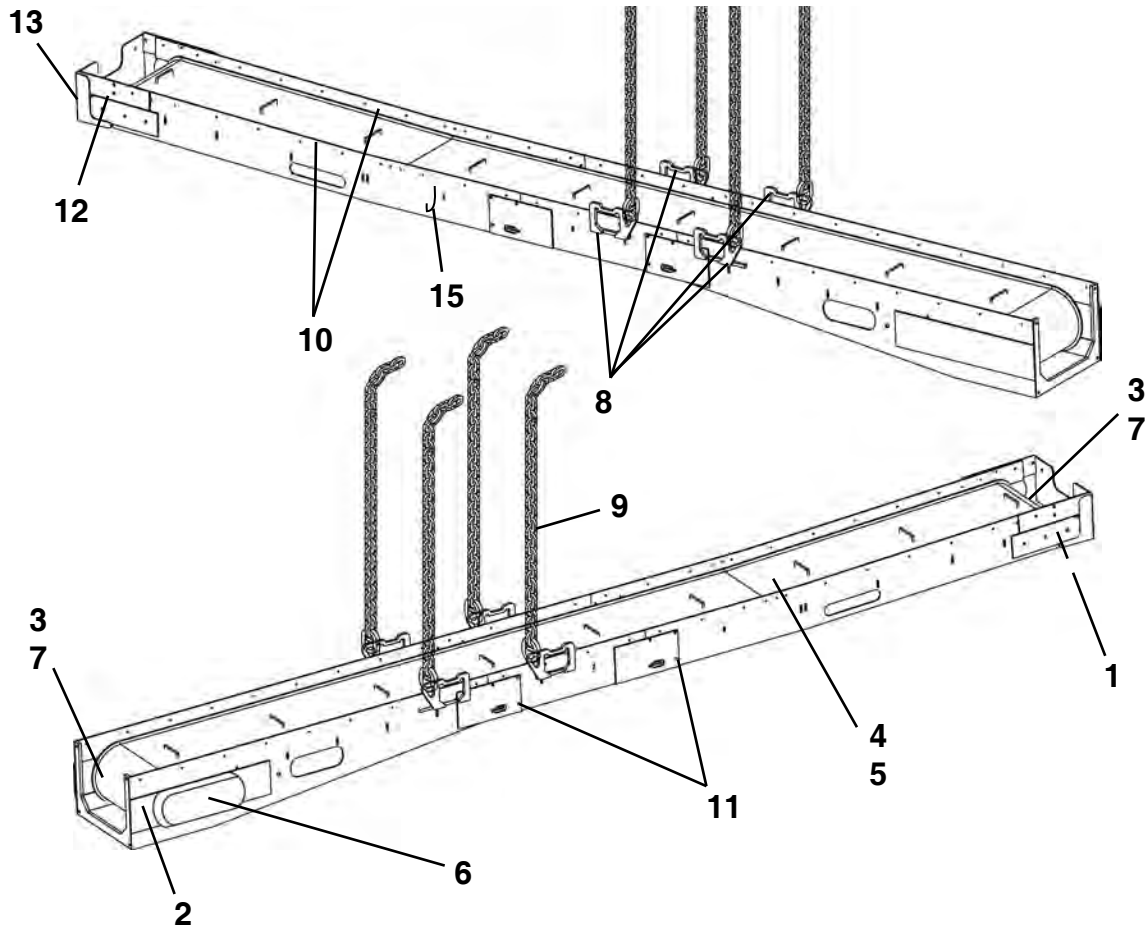

PRIOR TO EACH JOB LAUNCH

ITEM	COMPONENT	SERVICE	REQUIREMENT	MATERIAL
1.	Front Roller	Inspect & Lubricate	If damaged, replace with new.	Mobil XHP222
2.	Drive Roller & Brg.	Inspect & Lubricate	If damaged, replace with new.	Mobil XHP222
3.	Roller Scrapers	Inspect	If damaged, replace with new.	
4.	Belt	Inspect	Replace if worn, cracked or damaged.	
5.	Belt Tension	Check	At center, max. 6" deflection.	
6.	Drive Chain	Inspect & Lubrication	Check for wear and tightness.	Mobil XHP222
7.	Belt Scrapers	Inspect	If damaged, replace with new.	
8.	Lift Eyes	Inspect	If damaged, replace with new.	
9.	Lifting Chain	Inspect	If damaged, replace with new.	
10.	Spoils Guide	Inspect	If damaged, replace with new.	
11.	Idler Rollers	Inspect & Lubricate	If damaged, replace with new.	Mobil XHP222
12.	Nose Bracket & Brg.	Inspect & Lubricate	If damaged, replace with new.	Mobil XHP222
13.	Dirt Guard	Inspect	If damaged, replace with new.	
*14.	Hydraulic Hoses	Inspect	If worn or damaged, replace with new.	
15.	Safety Hook	Inspect	If damaged, replace with new.	
*16.	Decals	Inspect		

* Not Shown

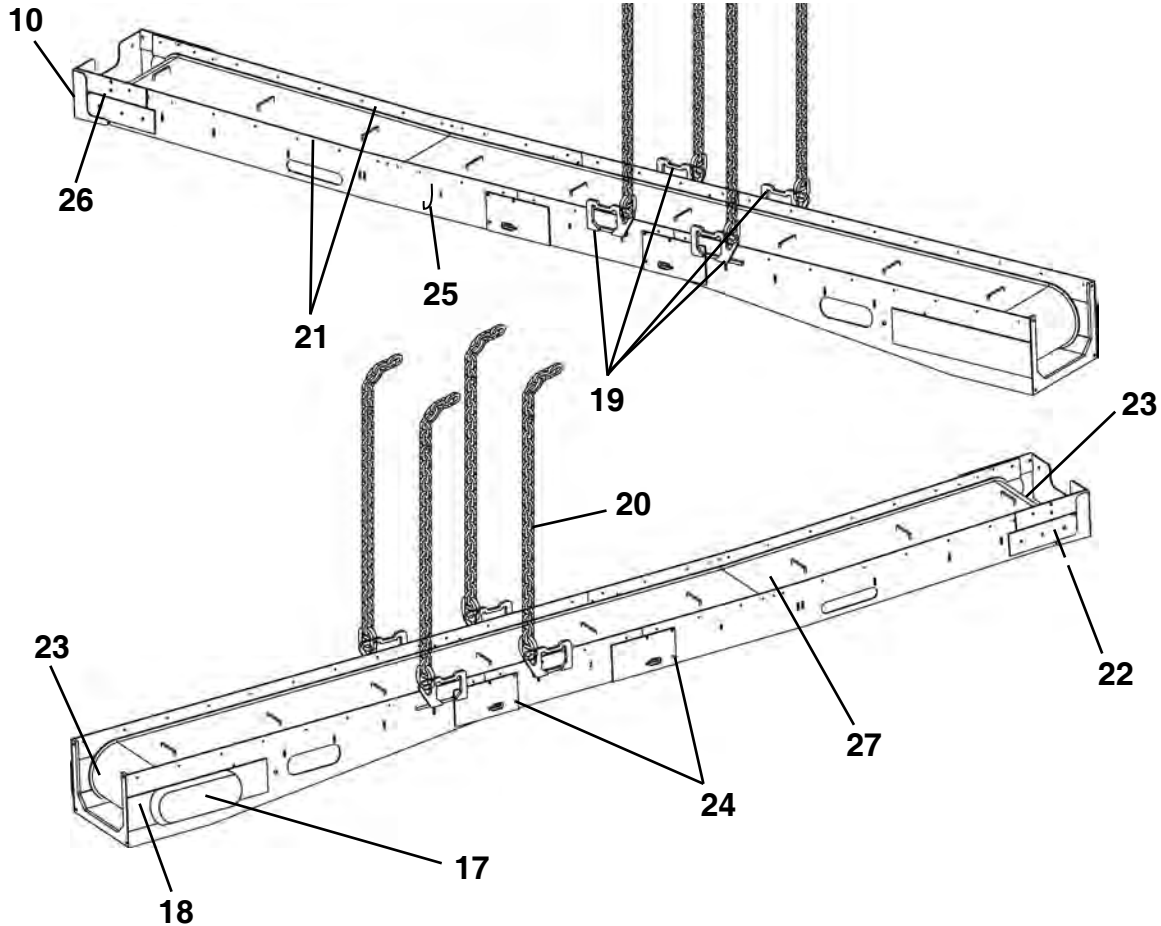

DAILY OR EVERY 10 HOURS OF OPERATION OR EACH SHIFT CHANGE

ITEM	COMPONENT	SERVICE	REQUIREMENT	MATERIAL
17.	Drive Cover	Inspect	If damaged, replace with new.	Mobil XHP222
18.	Drive Roller & Brgs.	Inspect & Lubricate	Replace if cracks/wear visible	
19.	Lift Eyes	Inspect	If damaged, replace with new.	
20.	Lifting Chain	Inspect	If damaged, replace with new.	
21.	Spoils Guide	Inspect	If damaged, replace with new.	
22.	Front Roller	Inspect	If damaged, replace with new.	
23.	Belt Scrapers	Inspect	If damaged, replace with new.	
24.	Idler Rollers	Inspect & Lubricate	If damaged, replace with new.	
25.	Safety Hook			
26.	Nose Bracket & Brg	Inspect & Lubricate	If damaged, replace with new.	
27.	Belt	Inspect	Replace if worn, cracked or damaged.	Mobil XHP222
*28.	Decals	Inspect		
*29.	Hydraulic Hoses	Inspect	If worn or damaged, replace with new.	

* Not Shown

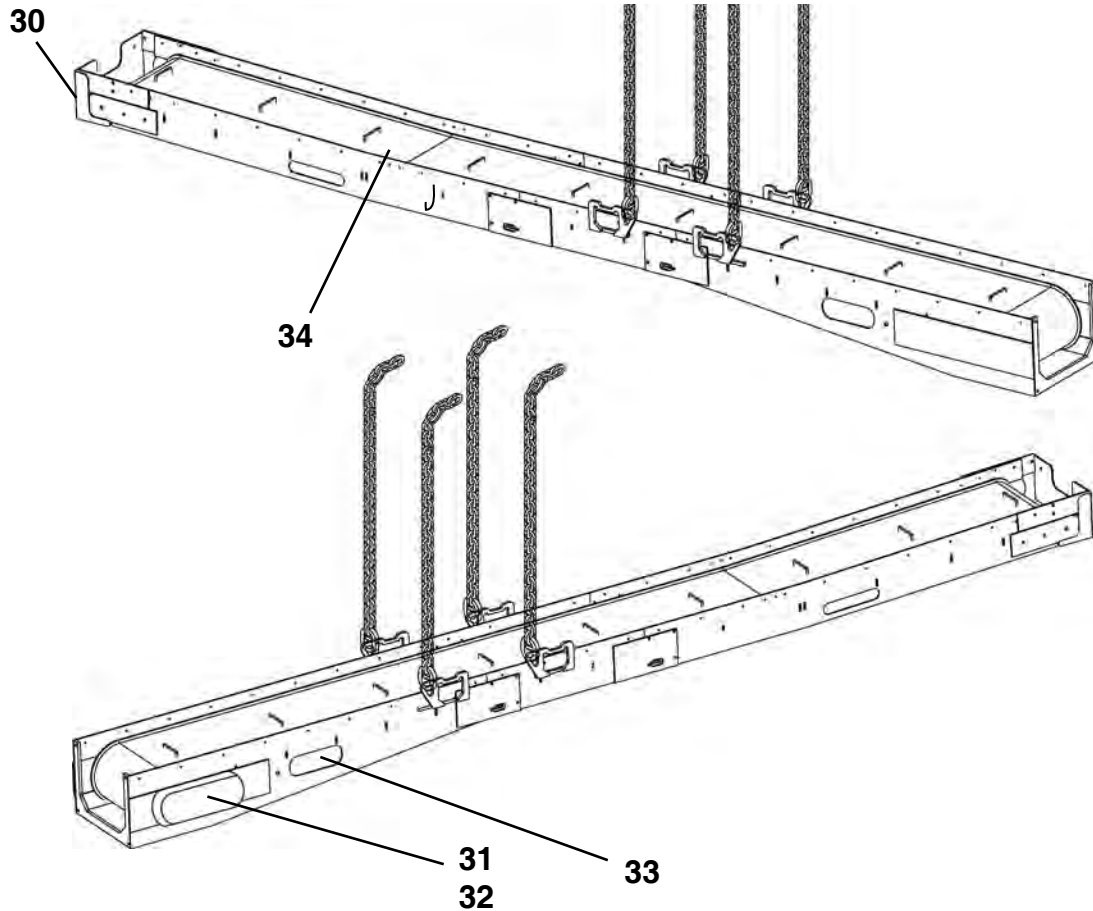

WEEKLY OR EVERY 50 HOURS OF OPERATION

ITEM	COMPONENT	SERVICE	REQUIREMENT	MATERIAL
30.	Dirt Guard	Inspect	If damaged, replace with new.	Mobil XHP222
31.	Drive Motor Bolts	Inspect for tightness	If damaged, replace with new.	
32.	Drive Chain	Inspect & Lubrication	Check for wear and tightness.	
33.	Belt Adjust Screw	Inspect & Lubricate		
34.	Belt Tension	Check	At center, max. 6" deflection.	

* Not Shown

PRIOR TO EACH JOB LAUNCH

1. INSPECT & LUBRICATE FRONT ROLLER

Inspect front roller (A) for wear or damage. If worn or damaged, replace with new.

Lubricate front roller bearings (B) (2 places) with Mobilgrease® XHP222 Premium Lubricating Grease or equivalent until grease is forced out.

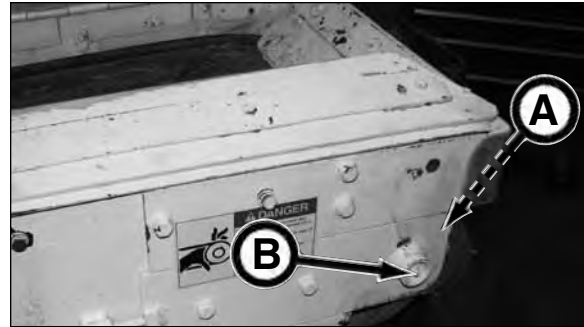

2. INSPECT & LUBRICATE DRIVE ROLLER & BEARING

1. Remove guard.
2. Inspect drive roller (C) for wear or damage. If worn or damaged, replace with new.
3. Lubricate drive roller pillow block bearings (D) (2 places) with Mobilgrease® XHP222 Premium Lubricating Grease or equivalent until grease is forced out.
4. Replace guard before operating conveyor.

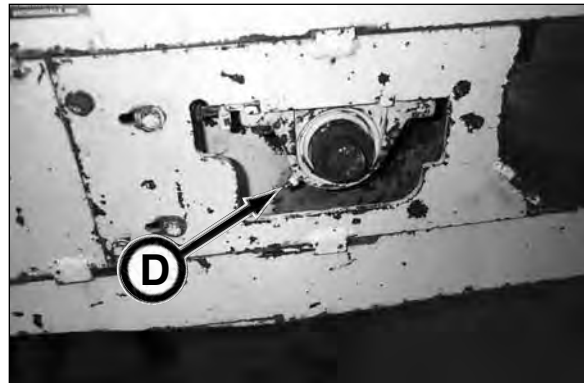
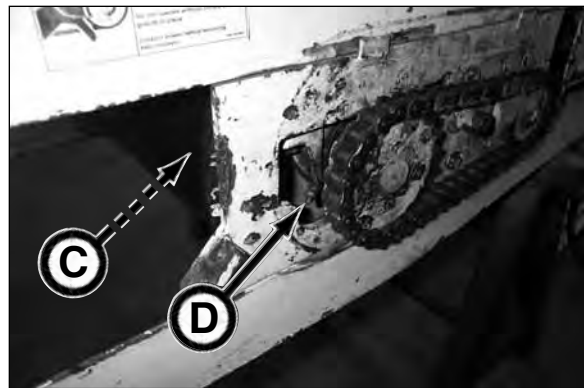

3. INSPECT ROLLER SCRAPERS

Inspect front roller (A) and the internal drive roller (B) scrapers for wear or damage. If worn or damaged, replace with new.

Check to be sure scrapers are adjusted so they are approximately 1/16 in. (1.5 mm) from the rollers.

Before operating conveyor, replace any cover/guards that were removed for this inspection.

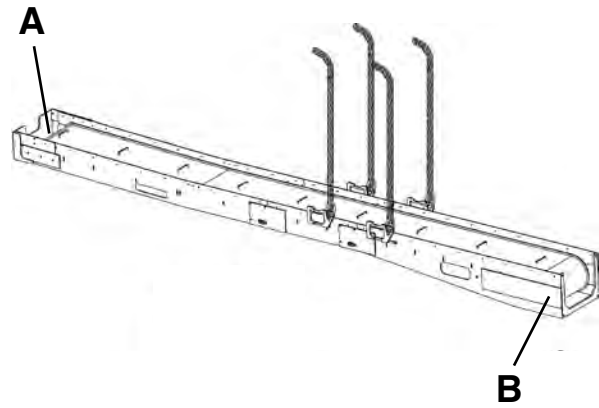

Internal Drive Roller Scraper Adjustment

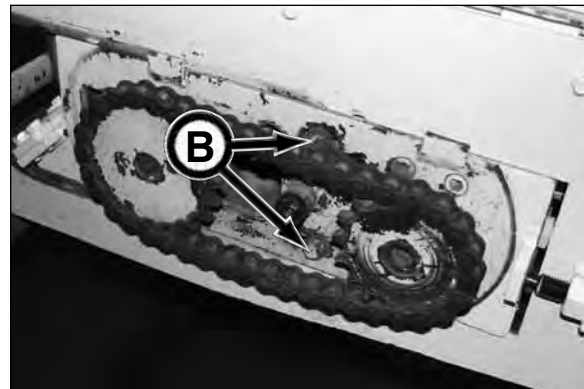

Internal Drive Roller Scraper Adjustment

4. INSPECT BELT

Inspect belt for cracks, wear, or damage. At the first sign of cracks, wear, or damage, replace conveyor belt.

Conveyor belt should be replaced if:

- The side ribs are worn to the point of no longer able to hold material.
- Cracks in the belt.
- Holes in the belt.
- Multiple belt lugs are missing.
- Belt can no longer be adjusted due to stretch in the belt.



5. CHECK BELT TRACKING & TENSION

Check the belt tracking as follows:

⚠ WARNING Contact with rotating conveyor belt or rollers will cause severe injury or death. Keep hands, body, and objects clear of rotating conveyor.

1. Remove or rotate spoil guides up out of the way of belt.
2. With personnel away from conveyor, start the conveyor belt rotation.
3. Observe the belt tracking the entire length of the conveyor. The gap between the belt and the conveyor must be the same on both sides.

⚠ WARNING NEVER adjust tracking while belt is rotating. Doing so can result in serious injury.

4. If the tracking requires adjustment, stop belt rotation and make small adjustments by using BOTH tracking adjustment bolts (A).
5. Start belt rotation and observe belt tracking. If further adjustment is needed, repeat steps 4 and 5 until the belt tracks straight on conveyor.
6. Once belt is tracking properly, stop belt rotation and lock out power to conveyor.

Check conveyor belt tension by:

1. Remove or rotate spoil guides up out of the way of belt.
2. In the center of the conveyor, lift the belt (B) and measure the deflection. The deflection should be a maximum of 6 in. (152 mm).

NOTICE Be sure the center rib on the under side of the belt stays in the groove of pulley.

Adjusting conveyor belt tension:

1. Use BOTH adjustment screws to tighten belt to a 6 in. (152 mm) deflection in the center of the conveyor. Use a tape measure to measure the distance from the conveyor frame (C) to the drive motor frame (D). This distance must be the same on both sides of the conveyor.

NOTICE Be sure to tighten BOTH adjustment screws the same rate or distance. Failure to do so will cause premature wear in the belt due to the tension being different on each side of the belt.

2. Once proper belt tension is achieved, the inner belt scrapers need to be readjusted for a 1/16 in. (1.5 mm) clearance.

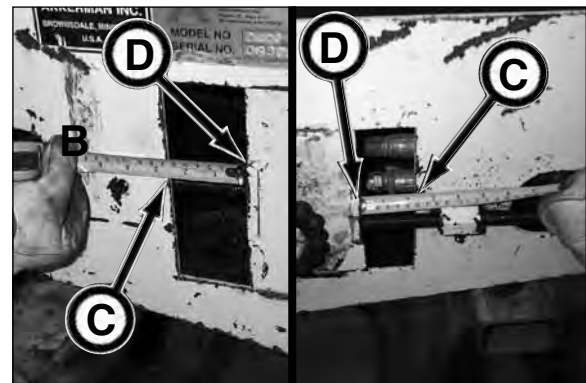

6. INSPECT & LUBRICATE DRIVE CHAIN

Inspect drive chain (A). If worn or damaged, replace with new.

Thoroughly lubricate chain with Mobilgrease® XHP222 Premium Lubricating Grease or equivalent.

Replace cover before operating conveyor.

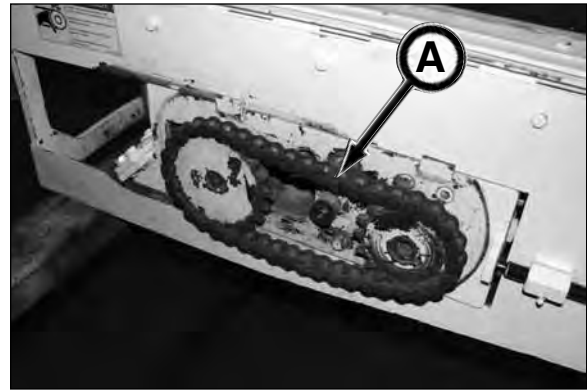

7. INSPECT BELT SCRAPERS

Inspect belt scrapers for wear or damage. If worn or damaged, replace with new.

Check to be sure scrapers are adjusted so they are approximately 1/16 in. (1.6 mm) from the belt.

⚠ WARNING Contact with rotating conveyor belt or idler rollers will cause severe injury or death. Keep hands, body, and objects clear of rotating conveyor.

Once scrapers are adjusted, run the conveyor belt and make sure the scrapers do not contact the belt. If so, the scrapers **MUST** be readjusted. Once adjusted, stop belt rotation and lock out power to conveyor.

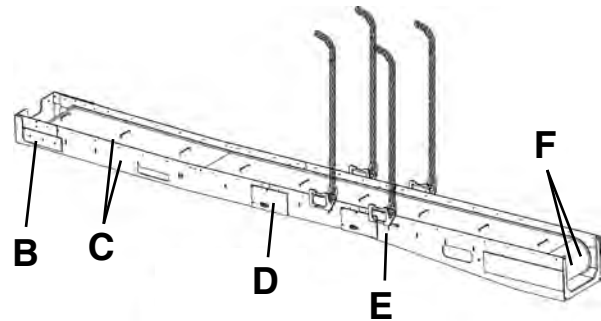

- B - Front End External Belt Scraper
- C - Inner Belt Scraper (2)
- D - Idler Roller Scraper for Extension Frame
- E - Idler Roller Scraper for Drive Frame
- F - External Belt Scraper (2)

8. INSPECT LIFTING EYES

Inspect lifting eyes (G) for wear or damage. If worn or damaged, replace with new.



9. INSPECT LIFTING CHAINS

Inspect lifting chains (A) for wear or damage. If worn or damaged, replace with new.

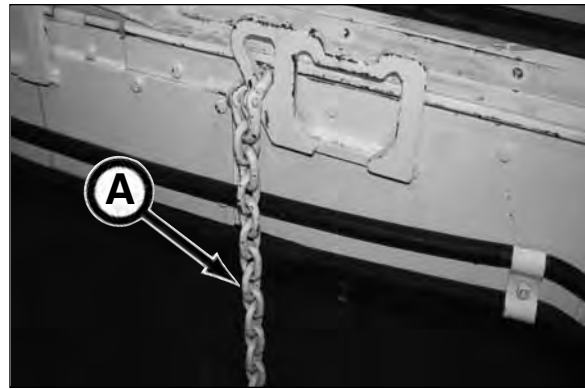

10. INSPECT SPOILS GUIDES

Inspect spoils guides (B) for wear or damage. If guide cannot be adjusted to within 1/4 in. (6.4 mm) of the belt, the guide should be replaced. Otherwise if damaged, replace with new.



11. INSPECT & LUBRICATE IDLER ROLLERS

Inspect idler rollers (C) for wear or damage. If worn or damaged, replace with new.

Lubricate idler roller bearings (D) (4 places) with Mobilgrease® XHP222 Premium Lubricating Grease or equivalent until grease is forced out.

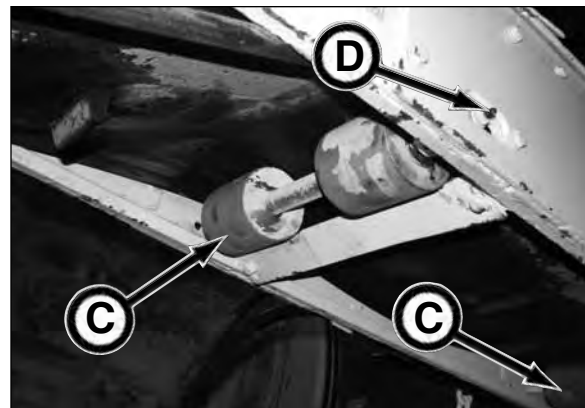

12. INSPECT & LUBRICATE NOSE BRACKET & BEARING

Inspect nose bracket (E) for wear or damage. If worn or damaged, replace with new.

Lubricate nose bearing (F) with Mobilgrease® XHP222 Premium Lubricating Grease or equivalent until grease is forced out.

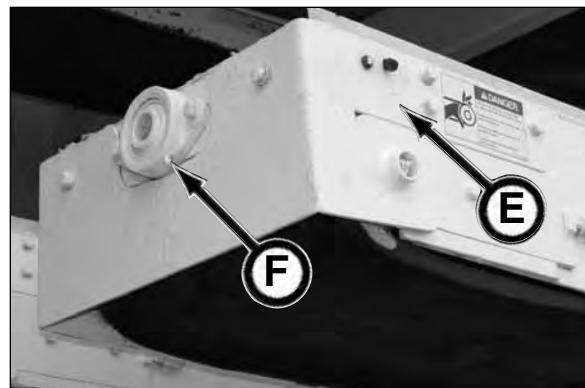

13. INSPECT DIRT GUARD

Inspect dirt guard (A) for wear or damage. If worn or damaged, replace with new.

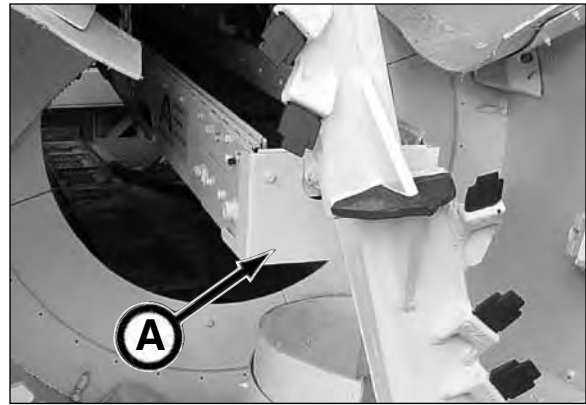

14. INSPECT HYDRAULIC HOSES

Inspect hydraulic hoses (B) for wear or damage. Repair or replace BEFORE operation.

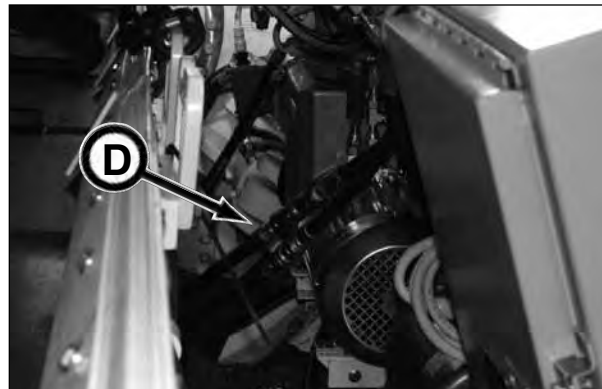

15. INSPECT CONVEYOR SAFETY HOOK

Inspect hook (C) for wear or damage. If worn or damaged, replace with new.



16. INSPECT DECALS

Inspect ALL decals, operational and safety decals to be sure they are clean and readable.

Use soft cloth, water, and a mild soap to clean the decals if they are too dirty to read. DO NOT clean safety decals with solvent. Solvent will damage decals. Replace decals immediately if they are damaged, missing, or hard to read.

Before applying a new decal, be sure the surface is clean and dry.



DAILY OR EVERY 10 HOURS OF OPERATION OR EACH SHIFT CHANGE

17. INSPECT DRIVE CHAIN COVER

Inspect drive chain (A) for wear or damage. If worn or damaged, replace with new.

NEVER operate conveyor without cover in place.

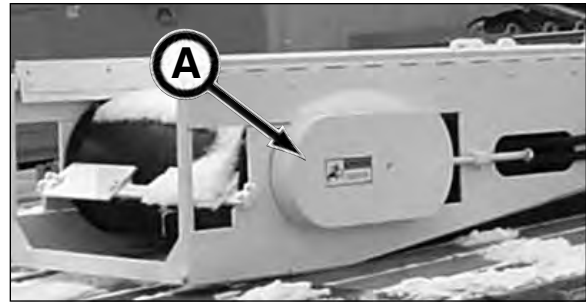

18. INSPECT & LUBRICATE DRIVE ROLLER & BEARING

1. Remove guard.
2. Inspect drive roller (C) for wear or damage. If worn or damaged, replace with new.
3. Lubricate drive roller pillow block bearings (D) (2 places) with Mobilgrease® XHP222 Premium Lubricating Grease or equivalent until grease is forced out.
4. Replace guard before operating conveyor.

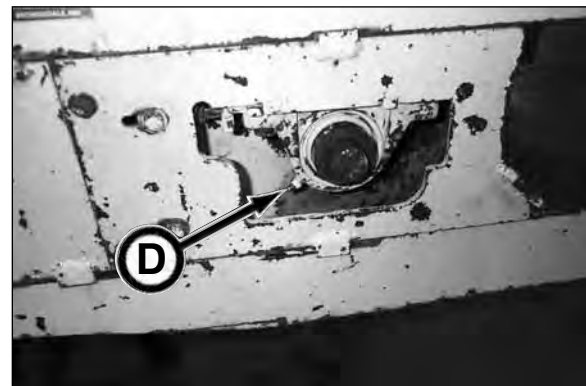
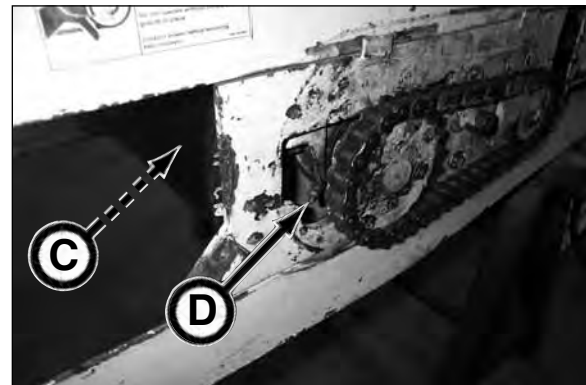

19. INSPECT LIFTING EYES

Inspect lifting eyes (E) for wear or damage. If worn or damaged, replace with new.



20. INSPECT LIFTING CHAINS

Inspect lifting chains (A) for wear or damage. If worn or damaged, replace with new.

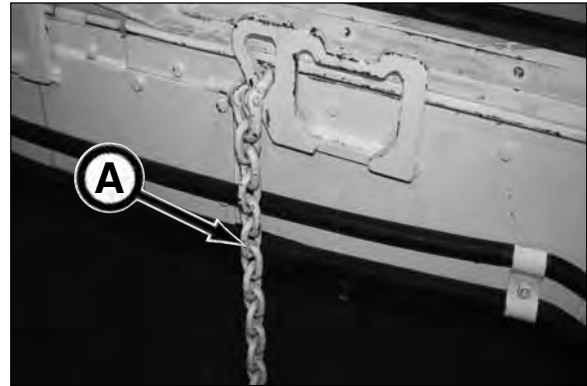

21. INSPECT SPOILS GUIDES

Inspect spoils guides (B) for wear or damage. If guide cannot be adjusted to within 1/4 in. (6.4 mm) of the belt, the guide should be replaced. Otherwise if damaged, replace with new.



22. INSPECT & LUBRICATE FRONT ROLLER

Inspect front roller (C) for wear or damage. If worn or damaged, replace with new.

Lubricate front roller bearings (D) (2 places) with Mobilgrease® XHP222 Premium Lubricating Grease or equivalent until grease is forced out.

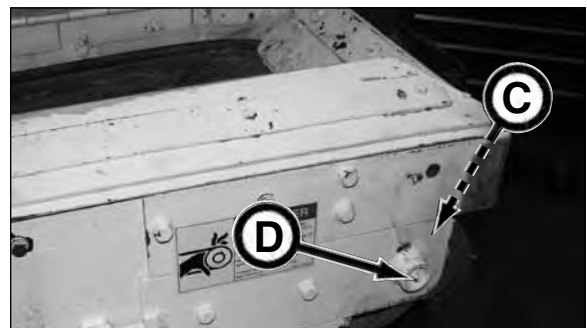

23. INSPECT BELT SCRAPERS

Inspect belt scrapers for wear or damage. If worn or damaged, replace with new.

Check to be sure scrapers are adjusted so they are approximately 1/16 in. (1.5 mm) from the belt.

⚠ WARNING Contact with rotating conveyor belt or idler rollers will cause severe injury or death. Keep hands, body, and objects clear of rotating conveyor.

Once scrapers are adjusted, run the conveyor belt and make sure the scrapers do not contact the belt. If so, the scrapers **MUST** be readjusted. Once adjusted, stop belt rotation and lock out power to conveyor.

- A - Front End External Belt Scraper
- B - Inner Belt Scraper (2)
- C - Idler Roller Scraper for Extension Frame
- D - Idler Roller Scraper for Drive Frame
- E - External Belt Scraper (2)

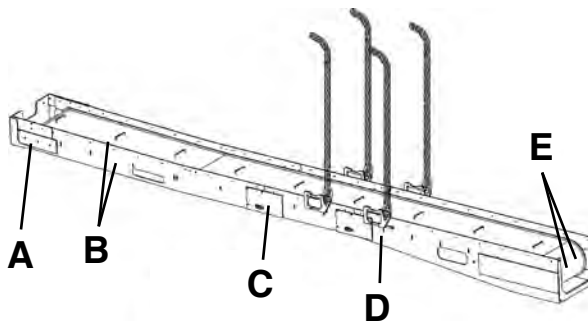

24. INSPECT & LUBRICATE IDLER ROLLERS

Inspect idler rollers (F) for wear or damage. If worn or damaged, replace with new.

Lubricate idler roller bearings (G) (4 places) with Mobilgrease® XHP222 Premium Lubricating Grease or equivalent until grease is forced out.

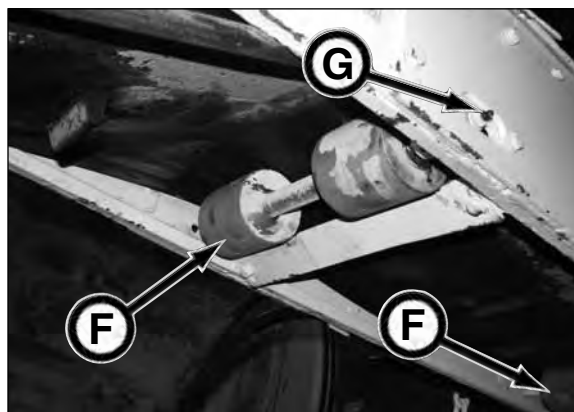

25. INSPECT CONVEYOR SAFETY HOOK

Inspect hook (H) for wear or damage. If worn or damaged, replace with new.



26. INSPECT & LUBRICATE NOSE BRACKET & BEARING

Inspect nose bracket (A) for wear or damage. If worn or damaged, replace with new.

Lubricate nose bearing (B) with Mobilgrease® XHP222 Premium Lubricating Grease or equivalent until grease is forced out.

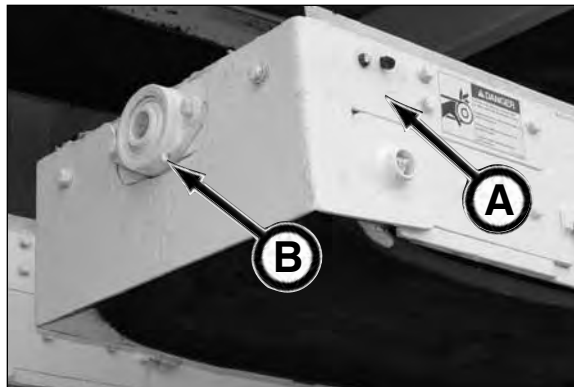

27. INSPECT BELT

Inspect belt for cracks, wear, or damage. At the first sign of cracks, wear, or damage, replace conveyor belt.

Conveyor belt should be replaced if:

- The side ribs are worn to the point of no longer able to hold material.
- Cracks in the belt.
- Holes in the belt.
- Multiple belt lugs are missing.
- Belt can no longer be adjusted due to stretch in belt.



28. INSPECT DECALS

Inspect ALL decals, operational and safety decals to be sure they are clean and readable.

Use soft cloth, water, and a mild soap to clean the decals if they are too dirty to read. DO NOT clean safety decals with solvent. Solvent will damage decals. Replace decals immediately if they are damaged, missing, or hard to read.

Before applying a new decal, be sure the surface is clean and dry.



29. INSPECT HYDRAULIC HOSES

Inspect hydraulic hoses (A) for wear or damage.
Repair or replace BEFORE operation.

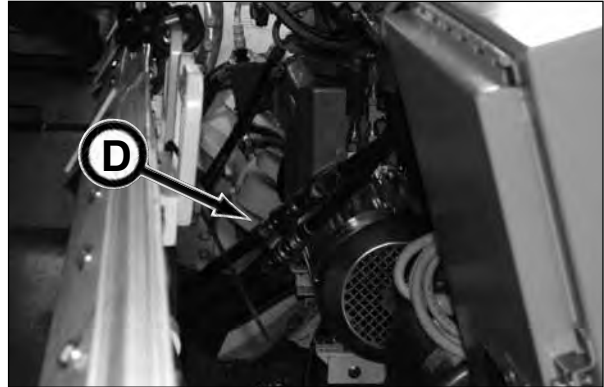

WEEKLY OR EVERY 50 HOURS OF OPERATION

30. INSPECT DIRT GUARD

Inspect dirt guard (A) for wear or damage. If worn or damaged, replace with new.

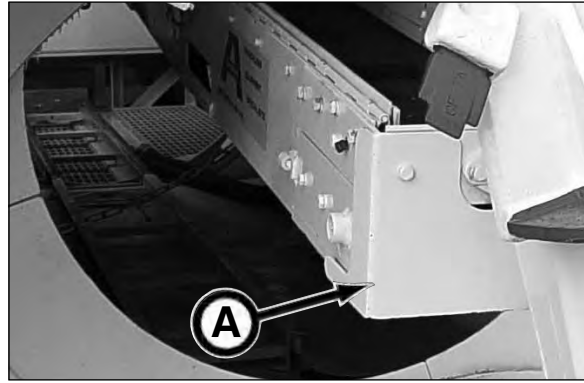

31. CHECK DRIVE MOTOR BOLT TIGHTNESS

Check drive motor bolt (B) tightness. Tighten bolts to the following torque:

3/8 in.	40 ft-lb. (54 N·m)
1/2 in.	90 ft-lb. (122 N·m)

If bolt (s) do not hold torque, the bolts must be replaced with new.



32. INSPECT & LUBRICATE DRIVE CHAIN

1. Inspect drive chain (C). If worn or damaged, replace with new.
2. Check chain tension. The center of the chain should have a maximum deflection of 3/16 in. (4.8 mm).

To adjust chain tension, loosen bolts (D) on pillow block bearings and tighten chain adjustment bolt (E) until the 3/16 in. (4.8 mm) deflection is achieved. Then retighten pillow block bearing bolts.

3. Thoroughly lubricate chain with Mobilgrease® XHP222 Premium Lubricating Grease or equivalent.

Replace cover before operating conveyor.

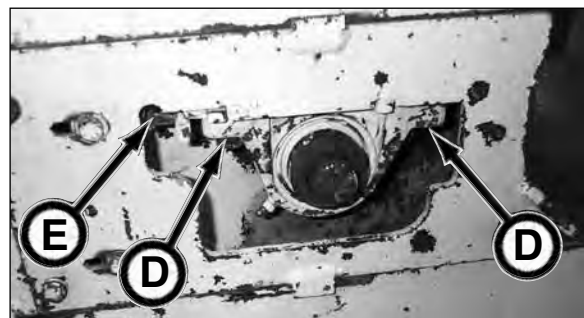
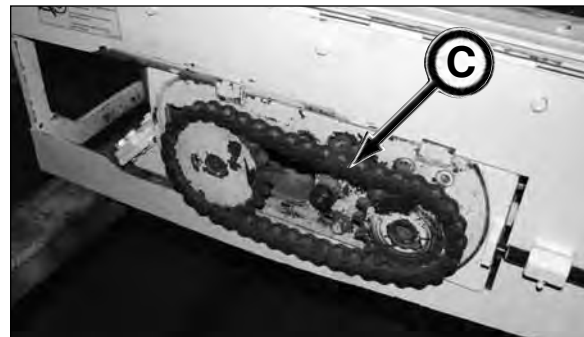

33. INSPECT & LUBRICATE BELT ADJUSTMENT SCREW

Inspect belt adjustment screw for wear or damage. If worn or damaged, replace with new.

Lubricate belt adjustment screw (2 places) with one shot of Mobilgrease® XHP222 Premium Lubricating Grease or equivalent.



34. CHECK BELT TRACKING & TENSION

Check the belt tracking as follows:

⚠ WARNING Contact with rotating conveyor belt or rollers will cause severe injury or death. Keep hands, body, and objects clear of rotating conveyor.

1. Remove or rotate spoil guides up out of the way of belt.
2. With personnel away from conveyor, start the conveyor belt rotation.
3. Observe the belt tracking the entire length of the conveyor. The gap between the belt and the conveyor must be the same on both sides.

⚠ WARNING NEVER adjust tracking while belt is rotating. Doing so can result in serious injury.

4. If the tracking requires adjustment, stop belt rotation and make small adjustments by using BOTH tracking adjustment bolts (A).
5. Start belt rotation and observe belt tracking. If further adjustment is needed, repeat steps 4 and 5 until the belt tracks straight on conveyor.
6. Once belt is tracking properly, stop belt rotation and lock out power to conveyor.



(continued on next page)

Check conveyor belt tension by:

1. Remove or rotate spoil guides up out of the way of belt.
2. In the center of the conveyor, lift the belt (A) and measure the deflection. The deflection should be a maximum of 6 in. (152 mm).

NOTICE Be sure the center rib on the under side of the belt stays in the groove of pulley.



Adjusting conveyor belt tension:

1. Use adjustment screws (2 places) to tighten belt to a 6 in. (152 mm) deflection in the center of the conveyor. Use a tape measure to measure the distance from the conveyor frame (B) to the drive motor frame (C). This distance must be the same on both sides of the conveyor.

NOTICE Be sure to tighten BOTH adjustment screws the same rate or distance. Failure to do so will cause premature wear in the belt due to the tension being different on each side of the belt.

2. Once proper belt tension is achieved, the inner belt scrapers need to be readjusted for a 1/16 in. (1.5 mm) belt clearance.



MAINTENANCE CHARTS - SCREW CONVEYOR

Use the item number in the chart to refer to the detailed maintenance procedures later in this section.

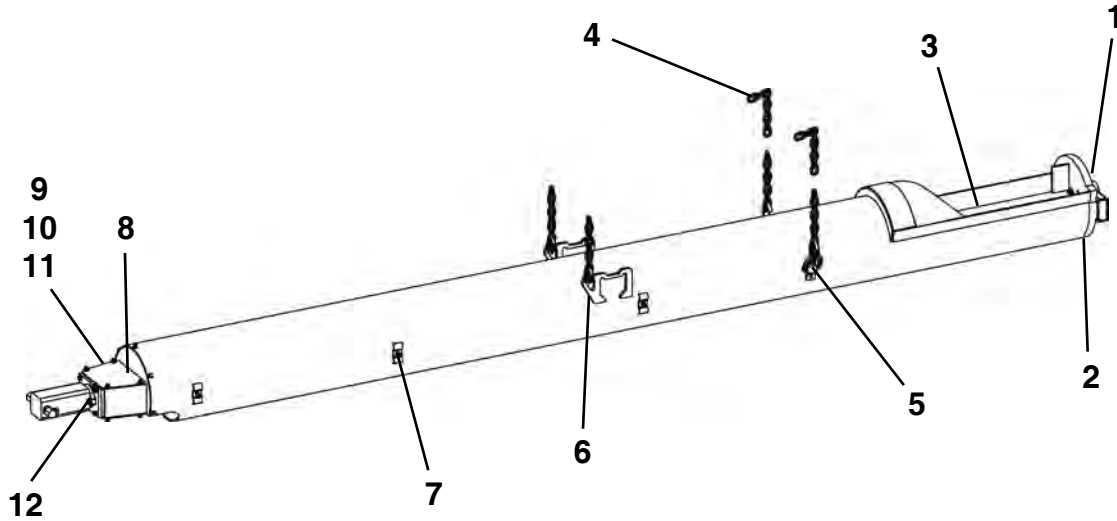

PRIOR TO EACH JOB LAUNCH

ITEM	COMPONENT	SERVICE	REQUIREMENT	MATERIAL
1.	Nose Bearing	Lubricate	Lubricate until grease is force out.	Mobil XHP222
2.	Tail End Inner Brg.	Lubricate	Lubricate until grease is force out.	Mobil XHP222
3.	Auger	Inspect	If damaged, repair or replace.	
4.	Lifting Chain	Inspect	If damaged, replace with new.	
5.	Lift D-Ring	Inspect	If damaged, replace with new.	
6.	Lift Eyes	Inspect	If damaged, replace with new.	
7.	Line Clamp	Inspect	If damaged, replace with new.	
8.	Drive End Inner Brg.	Lubricate	Lubricate until grease is force out.	Mobil XHP222
9.	Drive Chain	Lubricate	Lubricate thoroughly.	Mobil XHP222
10.	Drive Sprockets	Inspect	If damaged, replace with new.	
11.	Drive Guard	Inspect	If damaged, repair or replace.	
12.	Motor Bolts	Inspect	Tighten to 95 ft-lb (129 N·m)	
*13.	Hydraulic Hoses	Inspect	If worn or damaged, replace with new.	
*14.	Decals	Inspect	If damaged, replace with new.	

* Not Shown

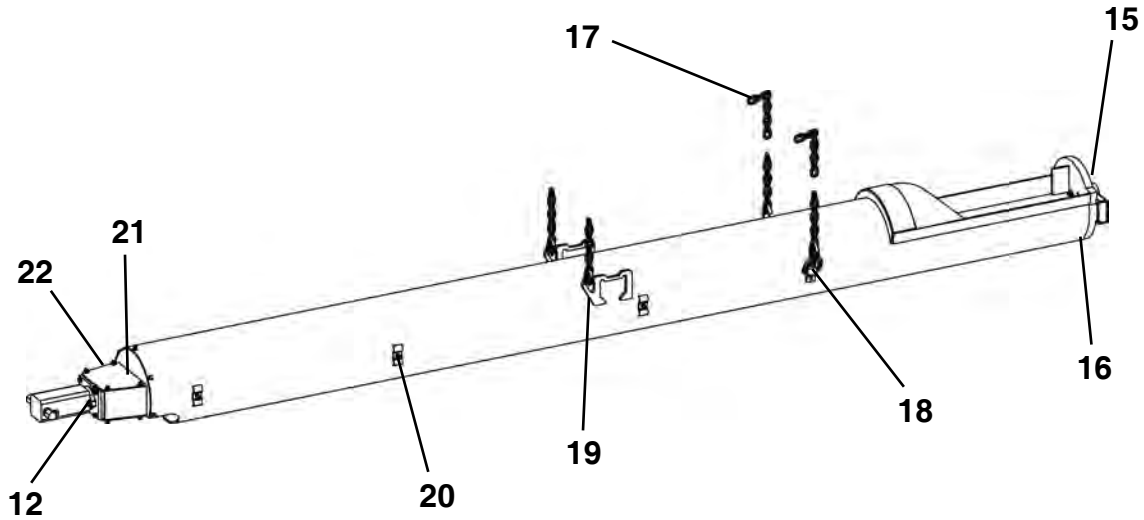

DAILY OR EVERY 10 HOURS OF OPERATION OR EACH SHIFT CHANGE

ITEM	COMPONENT	SERVICE	REQUIREMENT	MATERIAL
15.	Nose Bearing	Lubricate	Lubricate until grease is force out.	Mobil XHP222
16.	Tail End Inner Brg.	Lubricate	Lubricate until grease is force out.	Mobil XHP222
17.	Lifting Chain	Inspect	If damaged, replace with new.	
18.	Lift D-Ring	Inspect	If damaged, replace with new.	
19.	Lift Eyes	Inspect	If damaged, replace with new.	
20.	Line Clamp	Inspect	If damaged, replace with new.	
21.	Drive End Inner Brg.	Lubricate	Lubricate until grease is force out.	Mobil XHP222
22.	Drive Guard	Inspect	If damaged, replace with new.	
*23.	Hydraulic Hoses	Inspect	If worn or damaged, replace with new.	
*24.	Decals	Inspect	If damaged, replace with new.	

* Not Shown

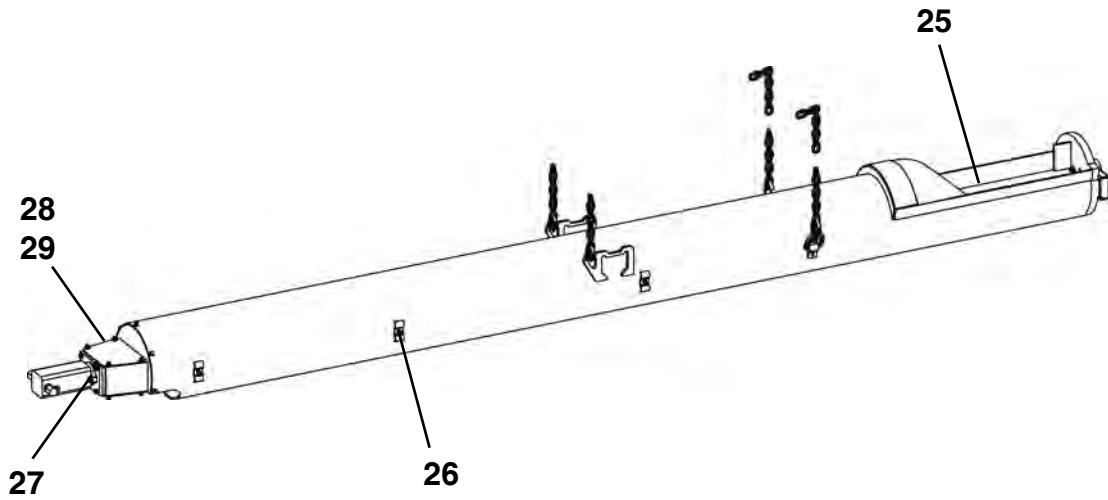

WEEKLY OR EVERY 50 HOURS OF OPERATION

ITEM	COMPONENT	SERVICE	REQUIREMENT	MATERIAL
25.	Auger	Inspect	If damaged, repair or replace.	Mobil XHP222
26.	Line Clamp	Inspect	If damaged, replace with new.	
27.	Motor Bolts	Inspect for tightness	Tighten to 95 ft-lb (129 N·m)	
28.	Drive Sprockets	Inspect	If damaged, replace with new.	
29.	Drive Chain	Lubrication	Lubricate thoroughly.	

* Not Shown

PRIOR TO EACH JOB LAUNCH

1. LUBRICATE NOSE BEARING

Lubricate nose bearing (A) with Mobilgrease® XHP222 Premium Lubricating Grease or equivalent until grease is forced out.

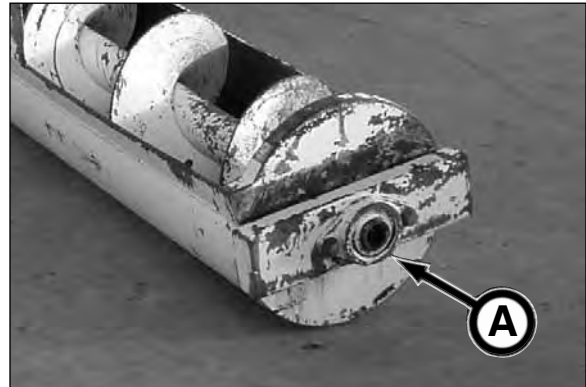

2. LUBRICATE TAIL END INNER BEARING

Lubricate inner bearing (B) (grease fitting located at bottom of conveyor) with Mobilgrease® XHP222 Premium Lubricating Grease or equivalent until grease is forced out.

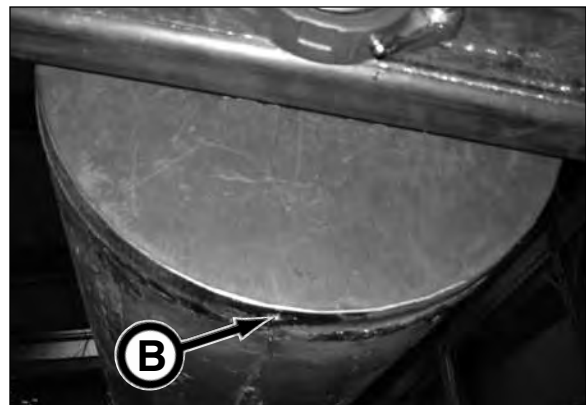
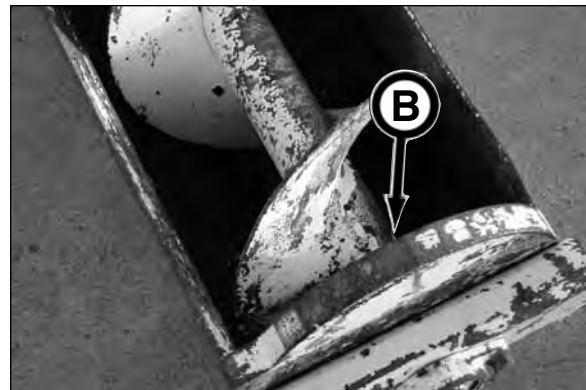

3. INSPECT AUGER

Inspect auger shaft (C) and flighting (D). If damaged, repair or replace with new.

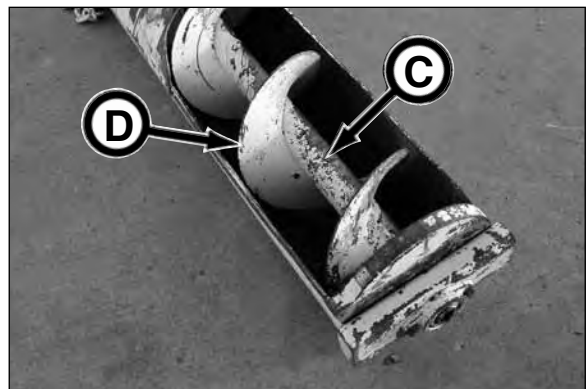

4. INSPECT LIFTING CHAINS

Inspect lifting chains (A) for wear or damage. If worn or damaged, replace with new.

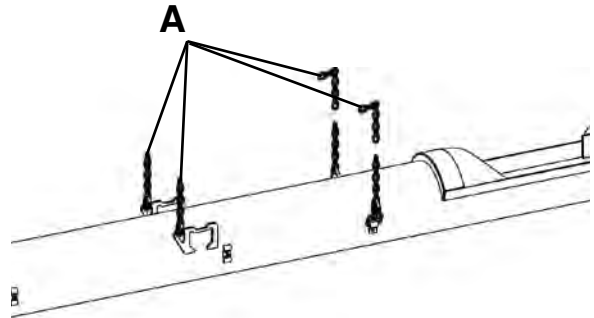

5. INSPECT LIFT D-RINGS

Inspect lift D-rings (B) for wear or damage. If worn or damaged, replace with new.

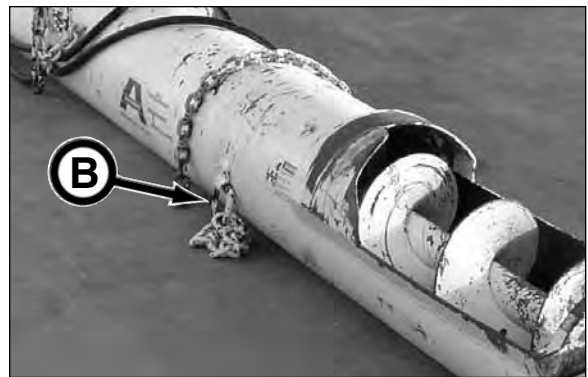

6. INSPECT LIFTING EYES

Inspect lifting eyes (C) for wear or damage. If worn or damaged, replace with new.

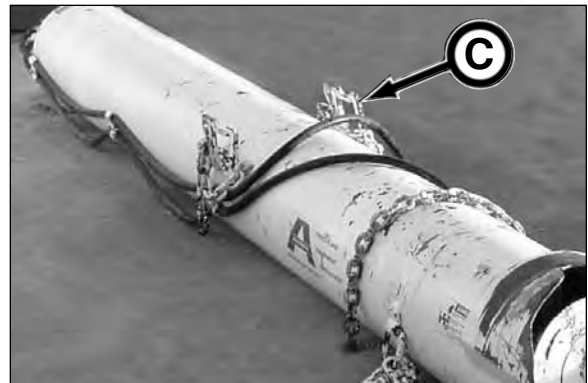

7. INSPECT LINE CLAMPS

Inspect line clamps (D) for wear or damage. If worn or damaged, replace with new.

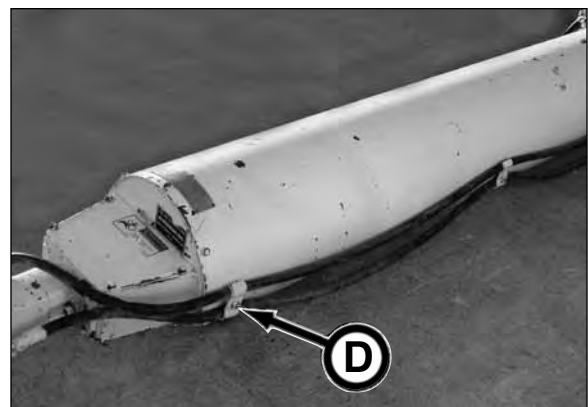

8. LUBRICATE DRIVE END INNER BEARING

1. Remove drive guard.
2. Lubricate inner bearing (A) with Mobilgrease® XHP222 Premium Lubricating Grease or equivalent until grease is forced out.
3. Replace drive guard before operating.

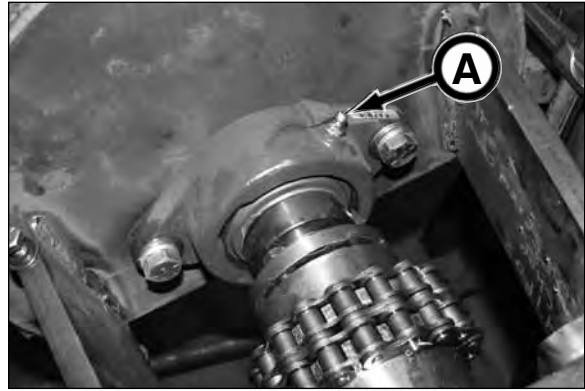

9. INSPECT & LUBRICATE DRIVE CHAIN

1. Remove drive guard.
2. Inspect drive chain (B). If worn or damaged, replace with new.
3. Thoroughly lubricate chain with Mobilgrease® XHP222 Premium Lubricating Grease or equivalent.
4. Replace drive guard before operating.

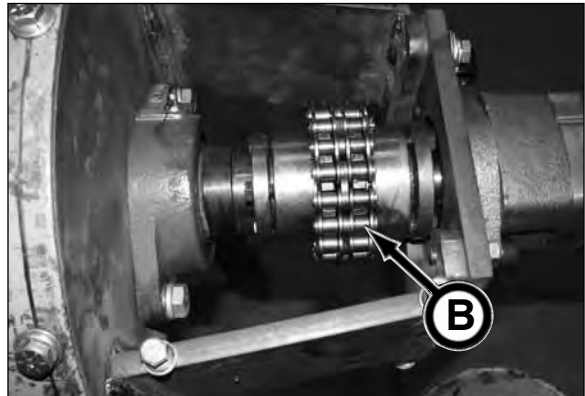

10. INSPECT DRIVE SPROCKETS

1. Inspect drive sprockets (C). If worn or damaged, replace with new.
2. Replace drive guard before operating.

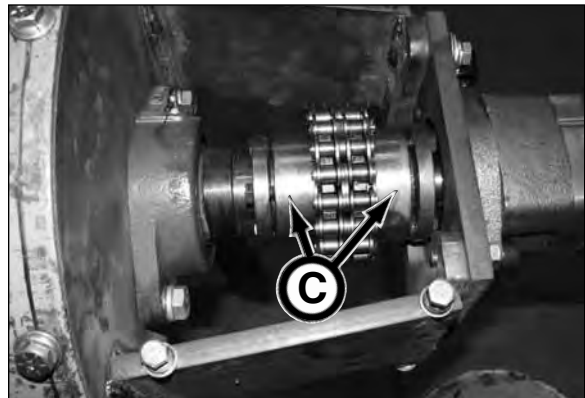

11. INSPECT DRIVE GUARD

Inspect drive guard (D). If worn or damaged, replace with new.

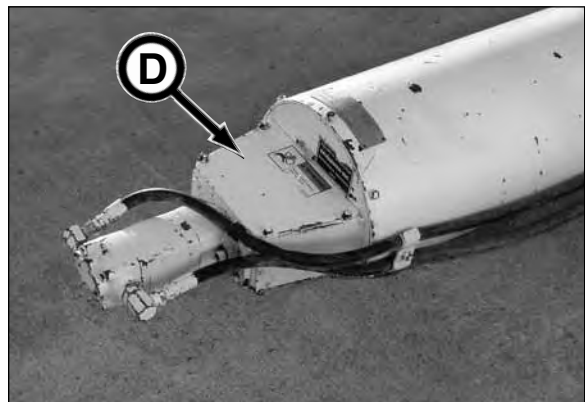

12. CHECK DRIVE MOTOR BOLT TIGHTNESS

Check drive motor bolt (A) tightness. Tighten bolts to the 95 ft-lb (129 N·m) torque.

If bolts do not hold torque, replace bolts with new.

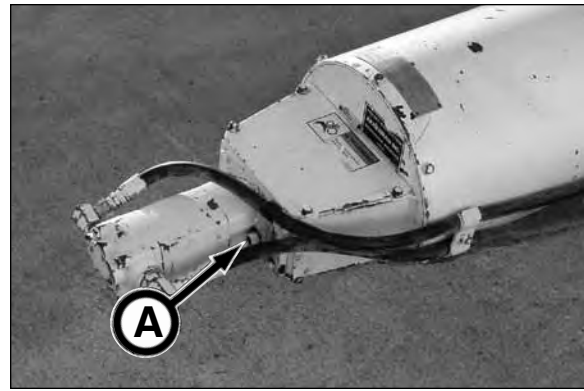

13. INSPECT HYDRAULIC HOSES

Inspect hydraulic hoses (B) for wear or damage. Repair or replace BEFORE operation.

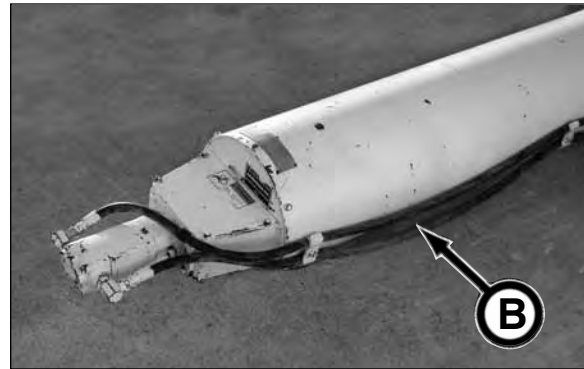

14. INSPECT DECALS

Inspect ALL decals, operational and safety decals to be sure they are clean and readable.

Use soft cloth, water, and a mild soap to clean the decals if they are too dirty to read. DO NOT clean safety decals with solvent. Solvent will damage decals. Replace decals immediately if they are damaged, missing, or hard to read.

Before applying a new decal, be sure the surface is clean and dry.

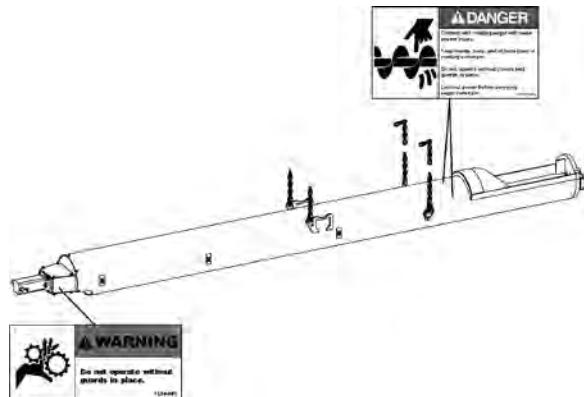

DAILY OR EVERY 10 HOURS OF OPERATION OR EACH SHIFT CHANGE

15. LUBRICATE NOSE BEARING

Lubricate nose bearing (A) with Mobilgrease® XHP222 Premium Lubricating Grease or equivalent until grease is forced out.

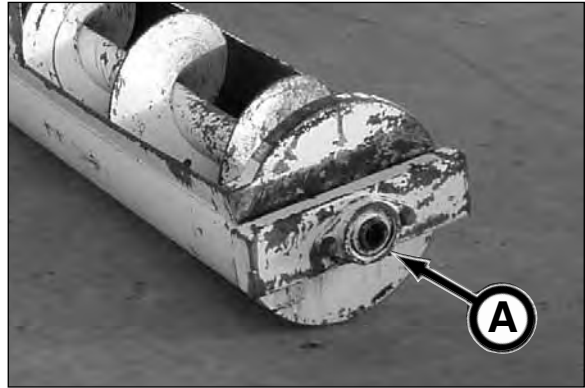

16. LUBRICATE TAIL END INNER BEARING

Lubricate inner bearing (B) (grease fitting location at bottom of conveyor) with Mobilgrease® XHP222 Premium Lubricating Grease or equivalent until grease is forced out.

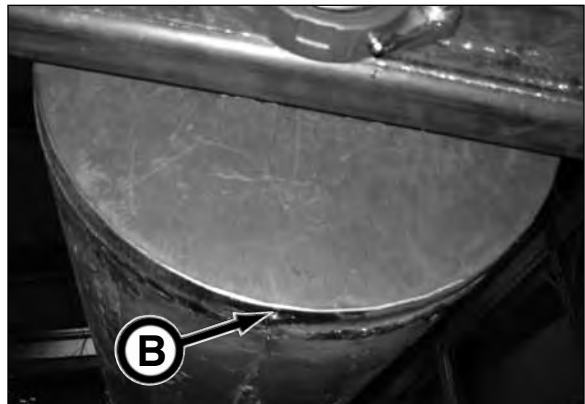
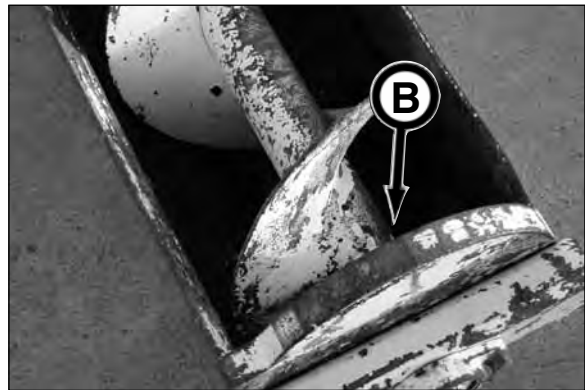

17. INSPECT LIFTING CHAINS

Inspect lifting chains (C) for wear or damage. If worn or damaged, replace with new.

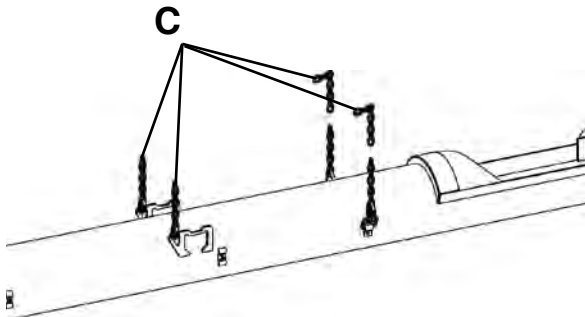

18. INSPECT LIFT D-RINGS

Inspect lift D-rings (A) for wear or damage. If worn or damaged, replace with new.

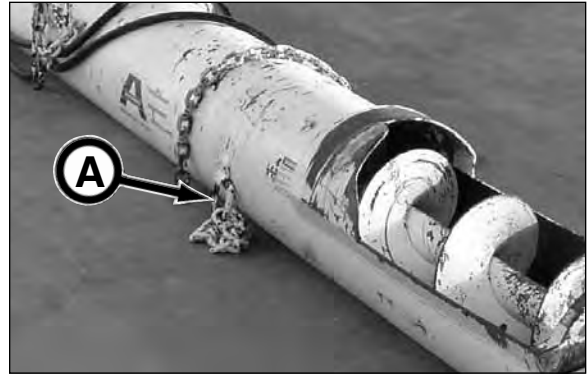

19. INSPECT LIFTING EYES

Inspect lifting eyes (B) for wear or damage. If worn or damaged, replace with new.

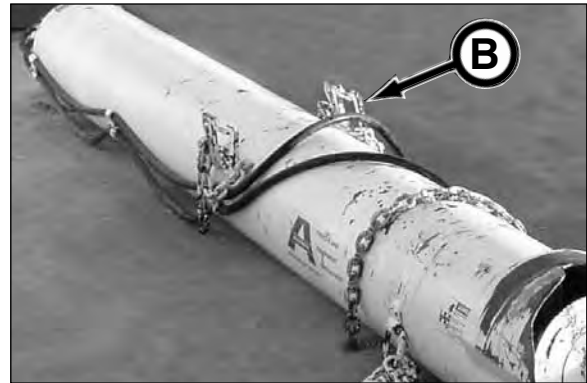

20. INSPECT LINE CLAMPS

Inspect line clamps (C) for wear or damage. If worn or damaged, replace with new.

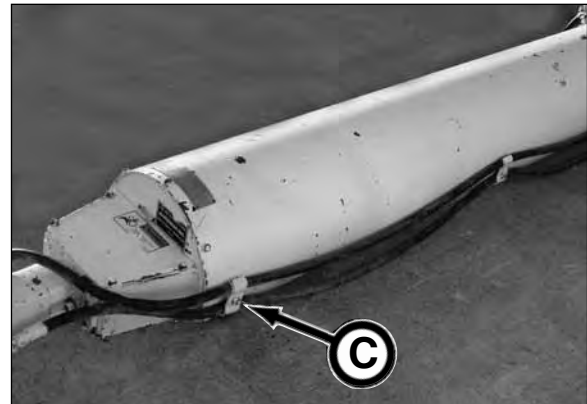

21. LUBRICATE DRIVE END INNER BEARING

1. Remove drive guard.
2. Lubricate inner bearing (D) with Mobilgrease® XHP222 Premium Lubricating Grease or equivalent until grease is forced out.
3. Replace drive guard before operating conveyor.

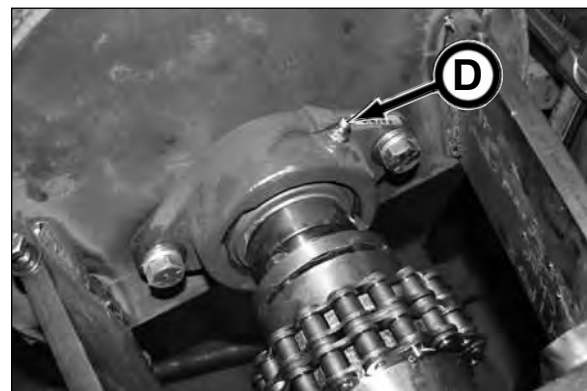

22. INSPECT DRIVE GUARD

Inspect drive guard (A). If worn or damaged, replace with new.

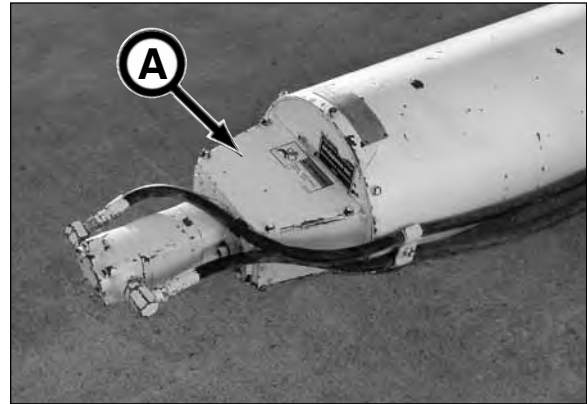

23. INSPECT HYDRAULIC HOSES

Inspect hydraulic hoses (B) for wear or damage. Repair or replace BEFORE operation.

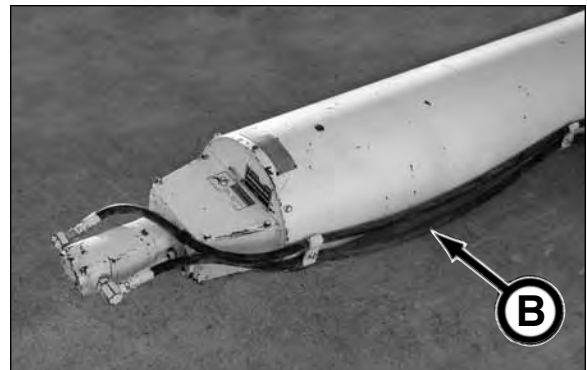

24. INSPECT DECALS

Inspect ALL decals, operational and safety decals to be sure they are clean and readable.

Use soft cloth, water, and a mild soap to clean the decals if they are too dirty to read. DO NOT clean safety decals with solvent. Solvent will damage decals. Replace decals immediately if they are damaged, missing, or hard to read.

Before applying a new decal, be sure the surface is clean and dry.

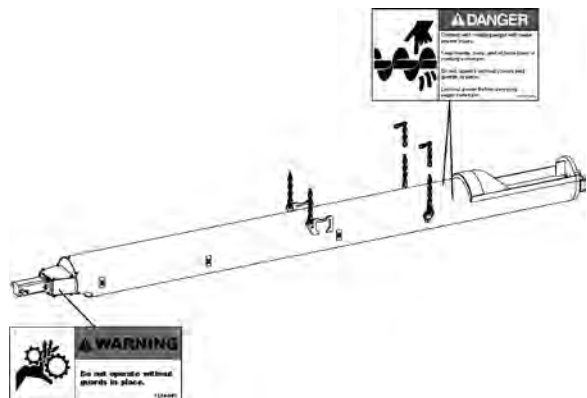

WEEKLY OR EVERY 50 HOURS OF OPERATION

25. INSPECT AUGER

Inspect auger shaft (A) and flighting (B). If damaged, repair or replace with new.

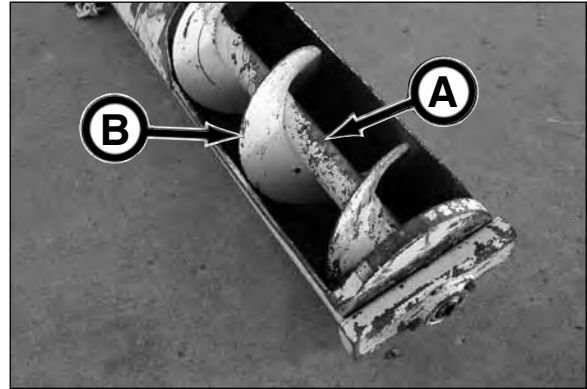

26. INSPECT LINE CLAMPS

Inspect line clamps (C) for wear or damage. If worn or damaged, replace with new.

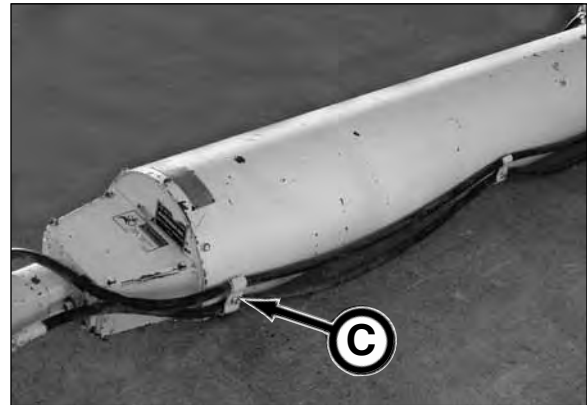

27. CHECK DRIVE MOTOR BOLT TIGHTNESS

Check drive motor bolt (D) tightness. Tighten bolts to the 95 ft-lb (129 N·m) torque.

If bolts do not hold torque, replace bolts with new.



28. INSPECT DRIVE SPROCKETS

1. Inspect drive sprockets (A). If worn or damaged, replace with new.
2. Replace drive guard before operating.

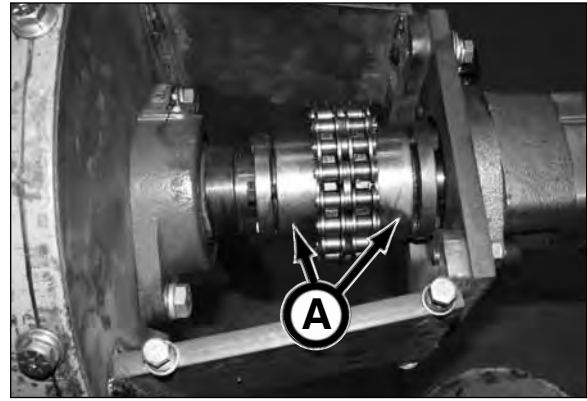

29. INSPECT & LUBRICATE DRIVE CHAIN

1. Remove drive guard.
2. Inspect drive chain (B). If worn or damaged, replace with new.
3. Thoroughly lubricate chain with Mobilgrease® XHP222 Premium Lubricating Grease or equivalent.
4. Replace drive guard before operating.

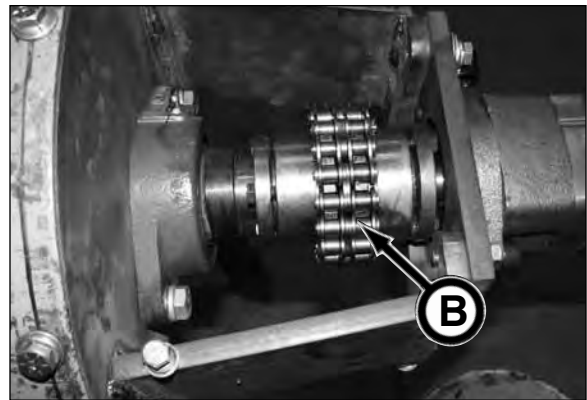

NOTES

Storage

PREPARING FOR STORAGE

NOTICE

Follow the lubrication and maintenance requirements in the Periodic Maintenance section.

1. Repair worn or damaged parts.
2. Wash all equipment thoroughly.
3. Lubricate all equipment grease points . Grease threads on bolts used for adjustments.
4. Retract all hydraulic cylinders if possible. If not, coat exposed cylinder rods with a corrosion preventive.
5. Repaint equipment where necessary.
6. Drain hydraulic oil, flush oil reservoirs, change hydraulic filters, and refill hydraulic reservoirs. Check for leaks.
7. Drain heat exchanger.
8. Wipe up lube spills. Dispose of rags and trash properly. Store oily rags and other flammable material in protective containers.
9. If possible, store equipment under cover and out of the weather in a ventilated area.
10. Do not smoke in areas where flammable materials are stored.
11. Store fuels and lubricants in properly marked containers.
12. Loosen belt on belt conveyor.

REMOVING FROM STORAGE

NOTICE

Follow the lubrication and maintenance requirements in the Periodic Maintenance section.

1. Clean equipment thoroughly.
2. Check to make sure all decals including safety decals are clean and readable.
3. Check condition of wires and cables. Repair or replace as necessary.
4. Remove the cylinder corrosion preventive from the cylinder rods if it is not compatible with hydraulic oil or seal materials.
5. Check for leaks. Repair or replace as necessary.
6. Check hydraulic oil level in reservoirs. If fluid is low, check for leaks and add oil as required. Refer to Lubricants section.
7. Check condition of all hoses and connections. Tighten, repair or replace with new as needed.
8. Before operating, cycle hydraulic functions several times to purge air from the hydraulic system.
9. Tighten belt tension on belt conveyor.
10. Review this Operator's Manual.

NOTES

Troubleshooting

TBM SERIES II

Problem	Cause	Solution
No hydraulic power at boring head:		
1. Check pressure reading at TBM - Gauge reads 0 psi.	Single feed supply line reversed.	Switch supply lines at pump unit.
	Supply valves not turned on at pump unit.	Turn on pump unit supply valves.
	Supply lines not connected to TBM.	Connect supply lines.
2. Check pressure reading at Pump Unit - Gauge reads approximately 500 psi.	Pilot pressure set too low, TBM rotating slowly.	Increase pilot pressure.
	Conveyor safety valve is in bypass position.	Reset safety valve.
	Pump unit supply valves in 30 gal supply position.	Set supply valve to 60 gal.
3. Check pressure reading at Pump Unit - Gauge reads 2800/4800 psi*	Pressure or return lines to boring head not connected.	Connect lines.
	Supply or return hose blockage.	Inspect hoses.
	Advancing TBM prior to rotating cutter head.	Retract steering cylinder and rotate cutter head.

* depending on hydraulic supply 3000/5000 psi.

(Continued on next page)

Problem	Cause	Solution
TBM Cutter Bar Stalling:		
Pressure reading at TBM with drum stalled:		
1. Gauge reads approximately 500 psi.	Conveyor safety valve tripped.	Reset valve.
2. Gauge reads more than 500 psi but less than 2000/4000 psi*	Relief setting low on pump unit.	Adjust accordingly.
	Pump compensator set too low.	Reset to 3,000 psi.
	Supply bleed off valves are open.	Close valves.
	Pump unit pump weak.	Test/replace pump.
3. Check pressure reading at Power Unit - Gauge reads 2800/4800 psi*	Unloading compensator is not fully closed when valve is at full stroke.	Clean or repair compensator.
	Obstacle in cut path.	Remove obstacle.
	Machine advancement rate too fast.	Slow advancement rate.
	Incorrect cutter teeth for ground condition.	Change to correct teeth.
	Insufficient number of drive motors installed.	Add drive motors.
	Motor(s) hydraulic hoses connected for wrong rotation on one or more motor.	Disengage all motors and test rotation.
TBM Dirt Wing will not extend/retract.	Worn or damaged cylinder seal.	Replace seals.
	Material build up or obstruction in ramp travel area.	Remove dirt wing, disassemble and clean.
	Pump unit supply control in neutral.	Turn supply control valve to 30 or 60 gal.
TBM, Conveyor Lift or Steering does not operate.	Worn or damaged cylinder seal.	Replace seal.
	Obstacle in travel area.	Remove obstacle.
	Steering cylinder remote relief set too low (TBM 420 - 660 only).	Adjust accordingly.

* depending on hydraulic supply 3000/5000 psi.

(Continued on next page)

Problem	Cause	Solution
<i>TBM Steering cylinder(s) collapse when forward thrust applied.</i>	Worn or damaged check valve.	Replace check valve.
	Faulty cylinder seals.	Replace seals.
	Obstruction against cutter ring.	Remove obstruction.
	Insufficient over-cut clearance.	Readjust over-cut (if available).
	Excessive thrust pressure.	Reduce thrust pressure.
<i>TBM will not steer up/down.</i>	Individual remote cylinder relief valve set too low.	Adjust accordingly.
	Worn or damaged cylinder seals.	Replace seals.
<i>TBM will not steer left/right.</i>	Check valve not releasing.	Replace check valve.
	Worn or damaged cylinder seals.	Replace seals.
<i>TBM inner drum turns too slowly (can build 2800/4800 psi).</i>	Check valve not releasing.	Replace check valve.
	Remote pilot control not in full stroke.	Move control to full stroke.
	30 gal supply control selected.	Select 60 gal supply control.
	Aux. pump unit motor not running.	Turn ON aux pump motor.
	Valve not in full stroke.	Move control to full stroke.
	Wrong supply flow selected.	Select correct supply flow.
<i>TBM cutter head will not make full revolution.</i>	Pump not running.	Start boring head pump.
	Obstruction in cut path.	Remove obstruction.
<i>No power in tunnel.</i>	Material build up under inner drum.	Remove build up and check for damage.
	Pump unit not powered.	Turn on power.
<i>Scavenging pump overflowing.</i>	Tunnel power not on.	Turn on tunnel power.
	Excessive leakage from pilot operated valves.	Check valve and repair as needed.

* depending on hydraulic supply 3000/5000 psi.

(Continued on next page)

CONVEYOR

Problem	Cause	Solution
Conveyor Stalls:		
1. Check conveyor operating pressure gauge - Gauge reads 500 - 1000 psi.		
<i>TEST: Disconnect conveyor hoses, turn valve on and read pressure gauge, turn valve off.</i>		
a. Gauge reads 2800 psi.	Low belt tension.	Tighten belt tension.
	Broken drive chain.	Replace drive chain.
	Worn or damaged conveyor drive motor.	Replace motor.
	Wet conveyor belt.	Tighten under belt scrapers.
b. Gauge reads less than 1500 psi.	Remote hydraulic control not in full stroke.	Move control to full stroke.
	Conveyor safety valve tripped.	Reset.
	Motor worn/leaking.	Replace motor.
	Conveyor quick coupler faulty or not properly connected.	Properly connect coupler or replace.
2. Check conveyor operating pressure gauge - Gauge reads 2800 psi.		
	Obstacle lodged in belt or drive chain.	Remove obstacle. Check belt and drive chain for damage.
	Conveyor quick coupler faulty or not properly connected.	Properly connect coupler or replace.
	Damaged bearing on conveyor.	Replace bearing.

TBM HYDRAULIC SCHEMATIC

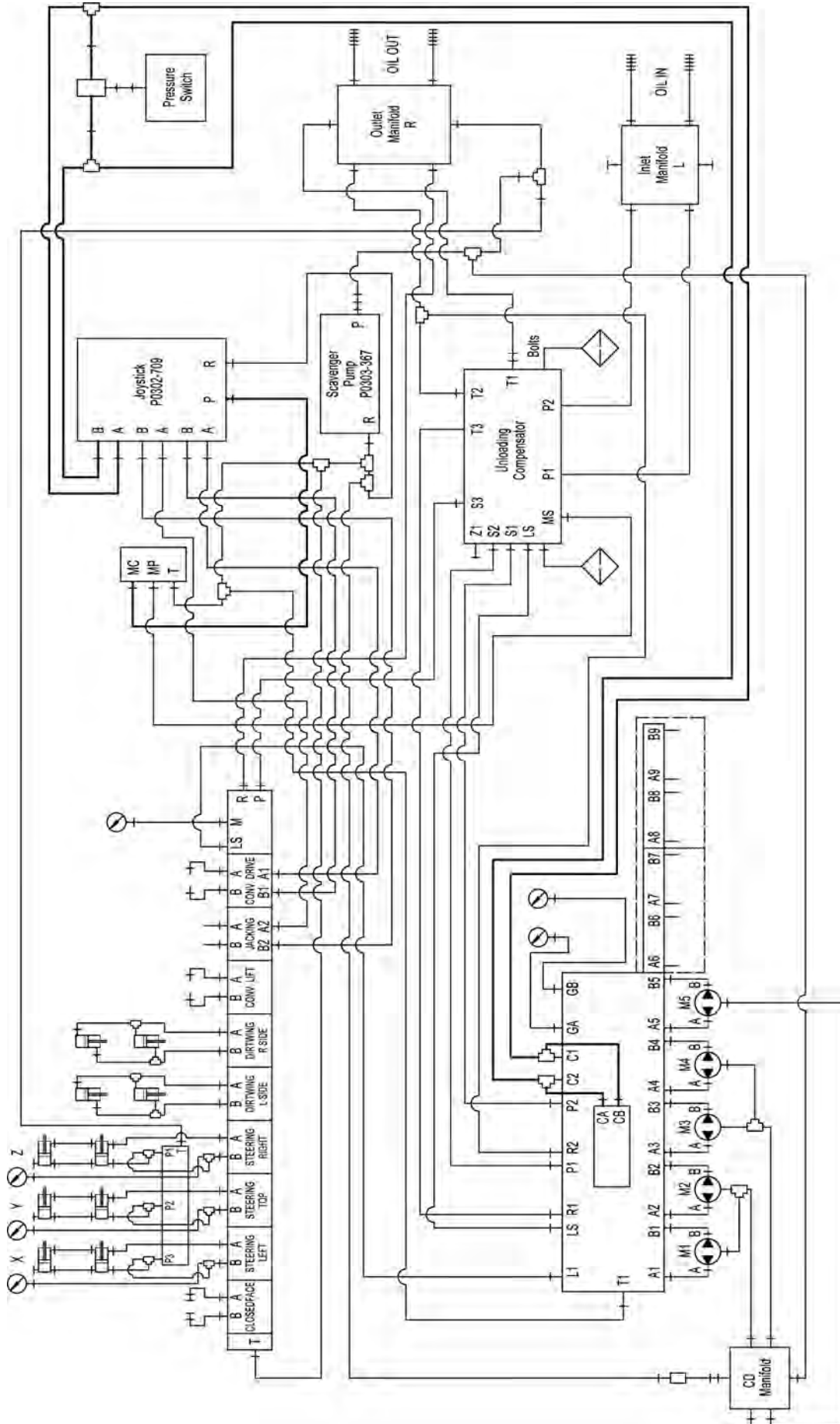

PIT POWER BOX ELECTRICAL SCHEMATIC

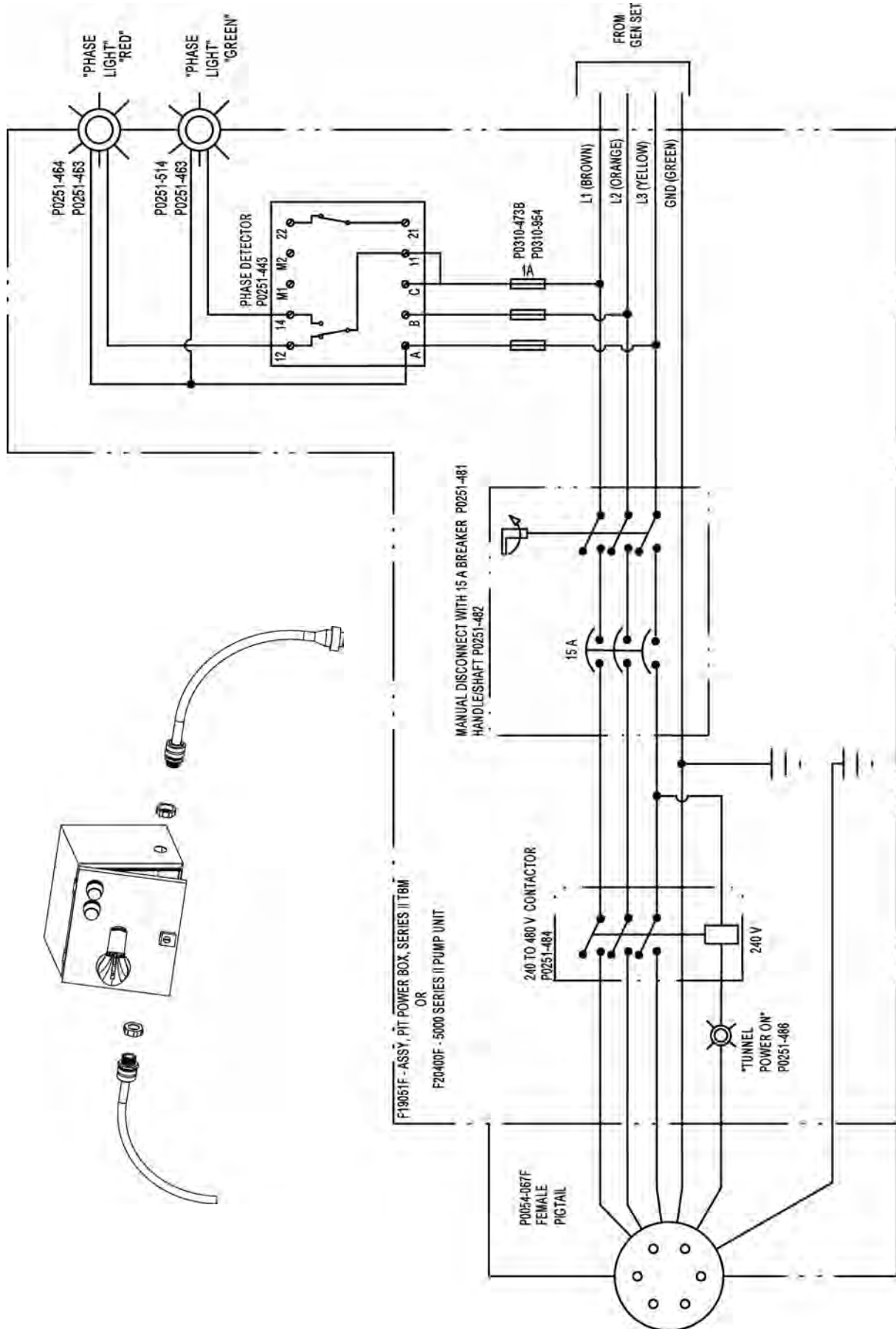

GREASE SYSTEM SCHEMATIC

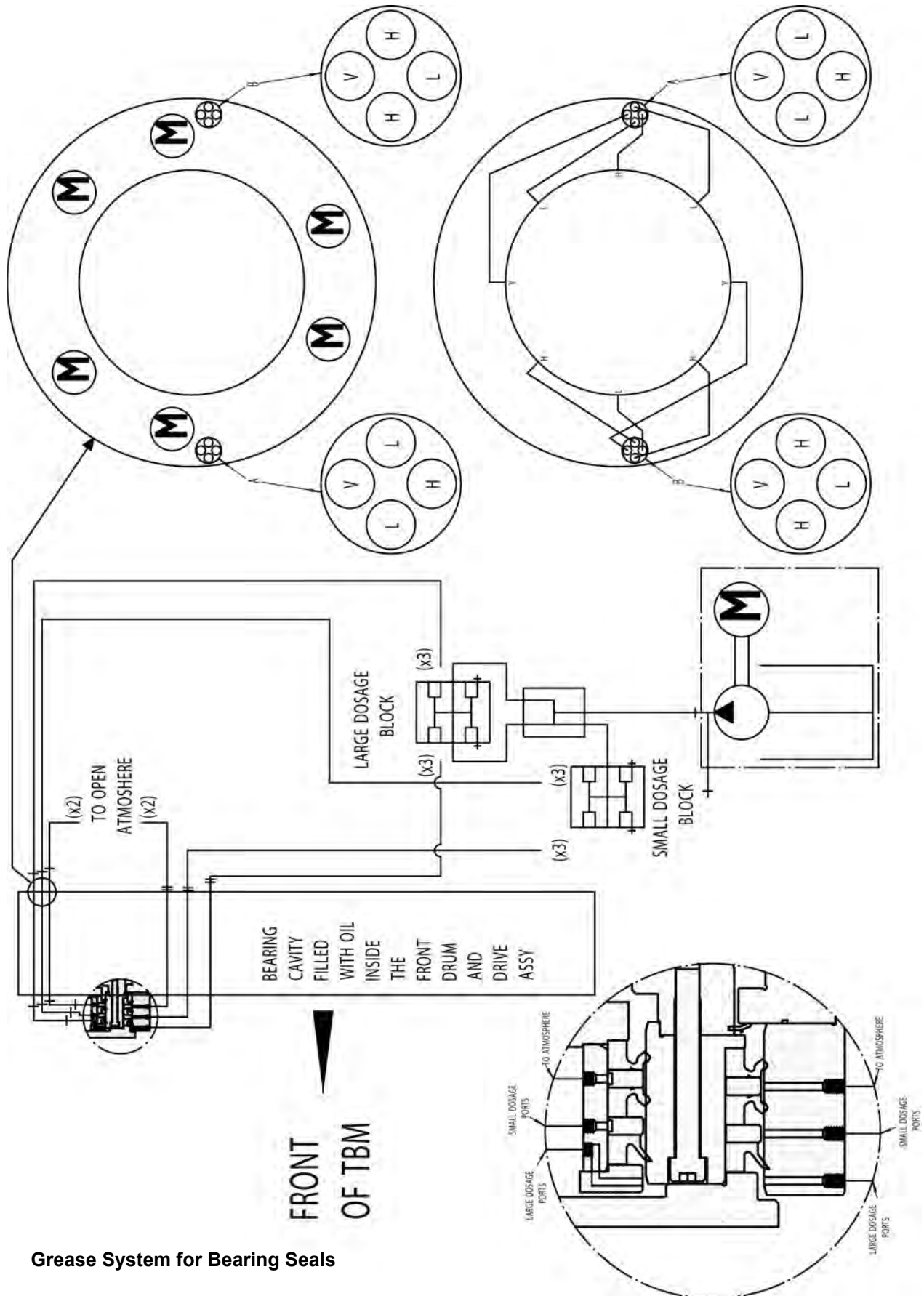

Grease System for Bearing Seals

LUBE SYSTEM SCHEMATIC

Oil Lubrication System for Bearing/Pinions

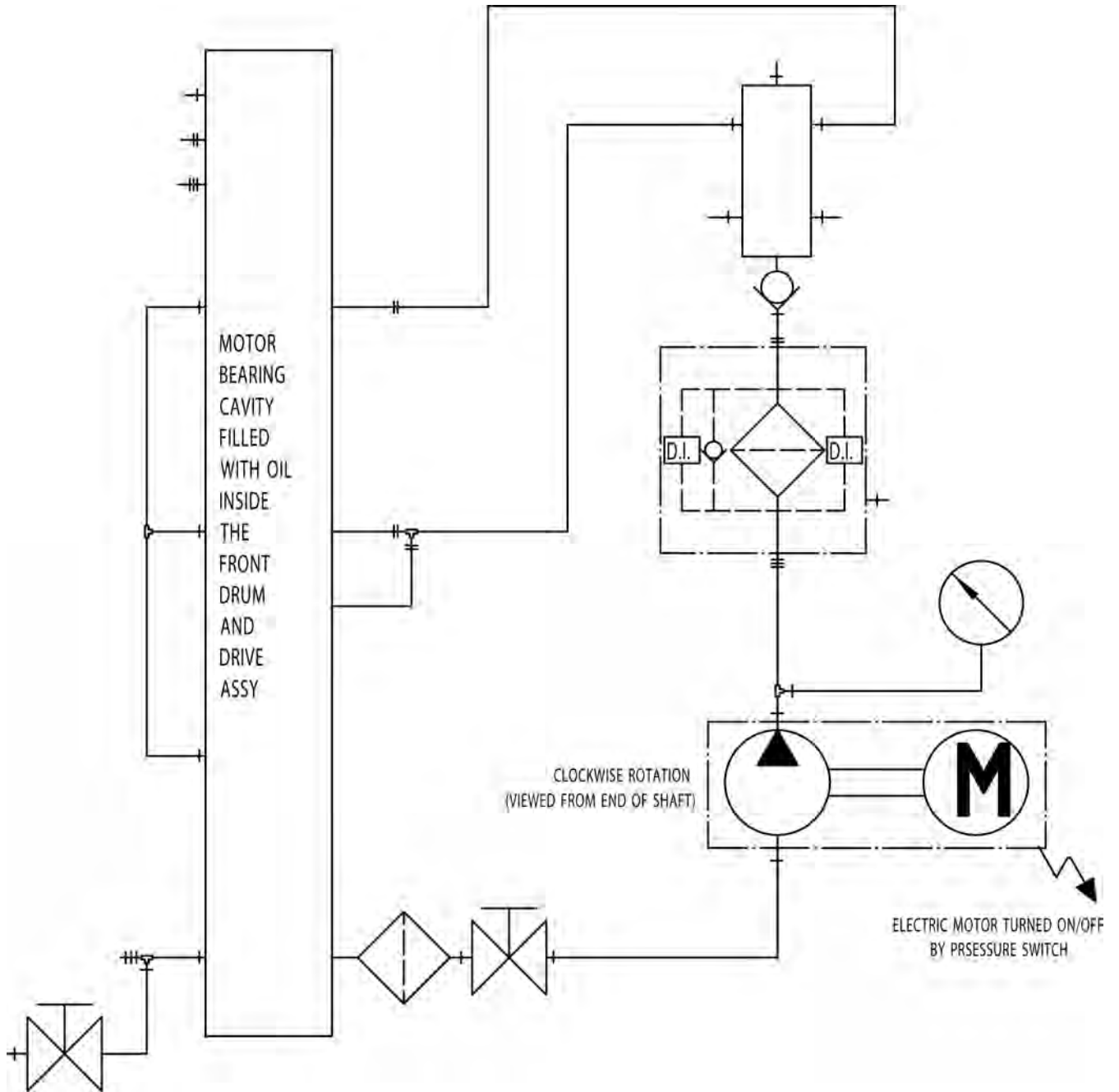

NOTES

Specifications

TUNNEL BORING MACHINE

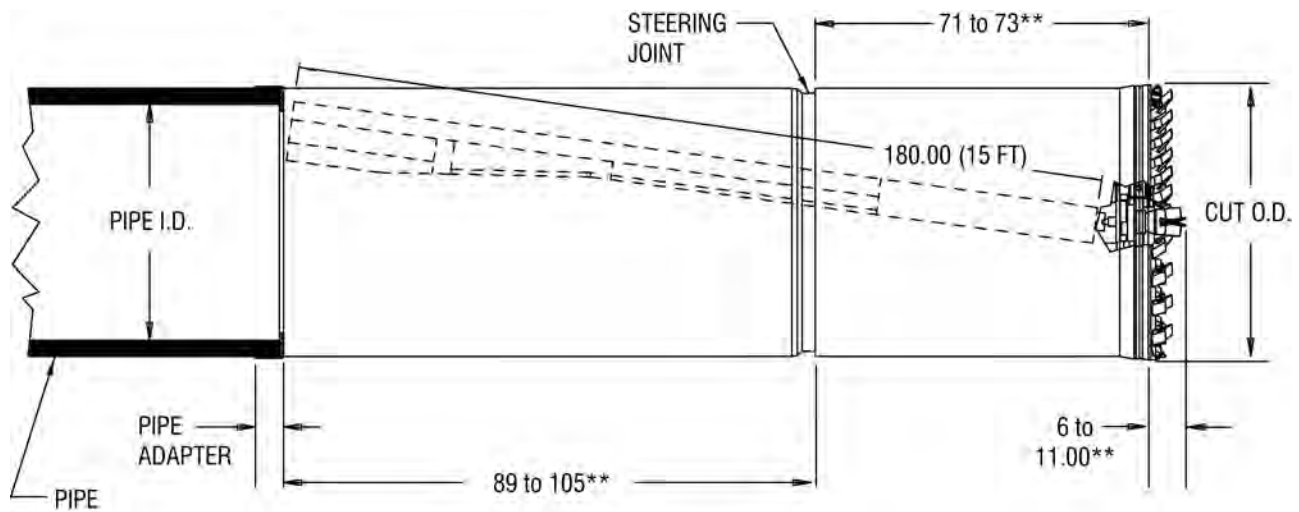

Dimensions shown in inches unless otherwise noted.

TBM Model	Wall Thickness	Pipe ID	Machine OD	Cutting Diameter	Drive Motors (30 CID)		Cutting Torque (ft-lbs) @ 3,000 psi	Cutting Torque (ft-lbs) @ 5,000 psi	Cutting Speed CW & CCW (based on 3,000 psi)
					Std	Max			
48SC	*	N/A	48"	49.5"	3		23,000	38,000	0-14.3 rpm @60gpm
						4	30,500	50,500	0-17.9 rpm @90gpm
420	B	42"	51"	52.5"	3		24,000	40,000	0-13.5 rpm @60gpm
						4	32,000	53,500	0-17.0 rpm @90gpm
480	B	48"	58"	59.5"	4		38,000	63,000	0-20.2 rpm @120gpm
						6	57,500	95,500	0-13.2 rpm @120gpm
540	B	54"	65"	66.5"	4		44,500	73,500	0-17.3 rpm @120gpm
						6	67,000	111,500	0-11.4 rpm @120gpm
600	B	60"	72"	73.5"	5		64,000	106,500	0-11.9 rpm @120gpm
						6	77,000	128,000	0-9.9 rpm @120gpm
660	B	66"	79"	80.5"	5		72,000	119,500	0-10.6 rpm @120gpm
						6	86,500	143,500	0-8.8 rpm @120gpm
720	B	72"	86"	87.5"	6		96,000	159,500	0-7.9 rpm @120gpm
						9	144,000	240,000	0-5.2 rpm @120gpm
780	B	78"	93"	94.5"	6		105,500	175,000	0-7.2 rpm @120gpm
						9	158,500	263,500	0-4.7 rpm @120gpm

* steel casing wall thickness is typically 1/2"

** depending on model

Increase kits are available to match specific pipe OD

ID - Inside Diameter OD - Outside Diameter

(Continued on next page)

Akkerman Inc. reserves the right to improve its product without notice or obligation.

Specifications - Tunnel Boring Machine

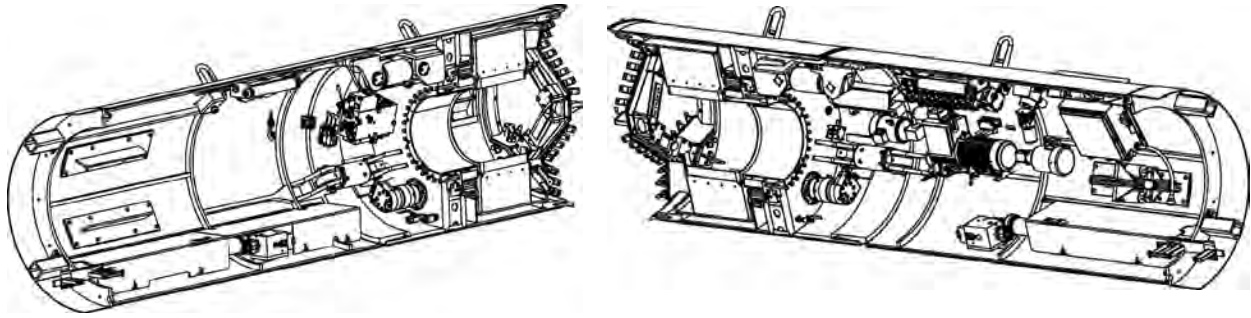

Hydraulics

Supply Flow 30 / 60 / 90 / 120 Gal
 Hydraulic Supply Operating Pressure 3,000 psi
 Hydraulic Supply Operating Pressure (Maximum)* 5,000 psi
 Filtration Two Pressure 10 Micron Filters

***Note: If operating between 3,000 - 5,000 psi, the TBM supply lines/hoses MUST be rated at 5,000 psi minimum.**

Cutterhead Drive

Rotational Speed Continuously variable in CW or CCW
 Drive Motors Refer to drive motor quantity on page 12-1
 Drive Motor Horsepower 30 HP

Cutterhead Bearing & Sealing

Bearing Type Three-row roller slewing bearing with integral drive gear
 Sealing System TBM lip seals with automated, pressurized grease flushing
 Bearing Cavity Oil Capacity (approx.) (volume dependant on model) 15 - 45 gal (57 L - 170 L)
 Lubrication System Fully automated oil circulation system continuously pressurized and filtered
 Seal Grease Container 20 lb. (9 kg)

Cutterhead

Standard Dirt/Carbide Cutter Bar & Sand Shelves
 Optional Closed Face

TBM Roll Control

Standard Two Hydraulic Torque Wings
 Optional Hydraulic Torque Wings, Hydraulic CW or CCW Dirt Wings

Safety Circuit

E-Stop Button Control System Shut Down
 Conveyor Safety Valve Switch Rotation Shut Down

Steering System

Articulation 3 Degrees
 Number of Cylinders (per model) Three or Six
 Cylinder Stroke (per model) 4 - 6 in. (102 - 152 mm)
 Rated Pressure* (per model) 4,100 - 5,000 psi

*** IMPORTANT: DURING TBM ADVANCEMENT, DO NOT ALLOW STEERING CYLINDER PRESSURES TO EXCEED RATED PRESSURE. DOING SO WILL CAUSE HYDRAULIC COMPONENT & STRUCTURAL DAMAGE.**

Gas Detector Methane Gas

Electrical

Power Supply (to Pump Unit) 480VAC, 3 Phase, 60 Hz, 400 Amp
 Power Supply (from Pump Unit to TBM) 480VAC, 3 Phase, 60 Hz, 15 Amp
 Transformer 24 VDC
 Tunnel Cable 10AWG/6C 90°C

Akkerman Inc. reserves the right to improve its product without notice or obligation.

CONVEYORS

BELT CONVEYOR

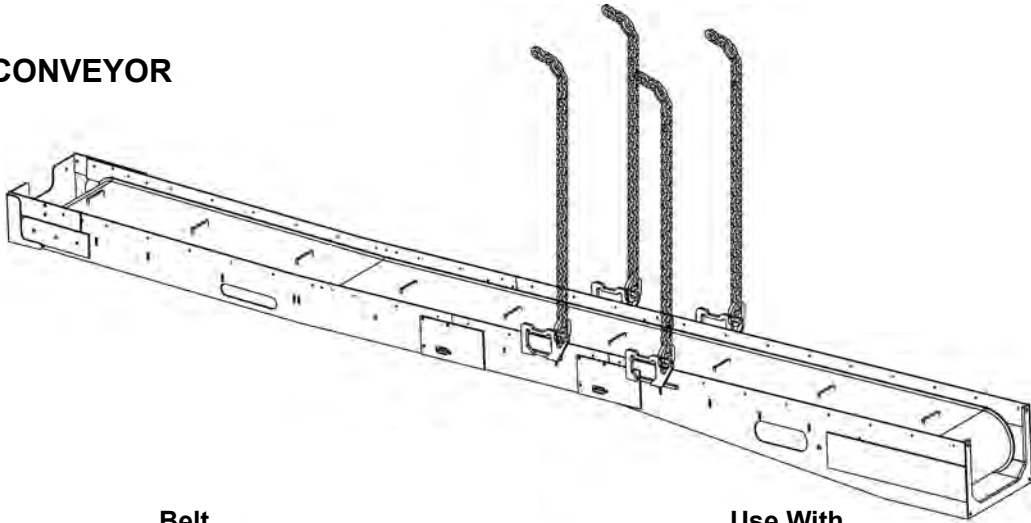

Model	Belt Size	Length	Use With TBM
1015	10"	15'	360, 48SC
1215	12"	15'	48SC, 420
1615	16"	15'	480, 540
2415	24"	15'	600, 660, 720, 780

SCREW CONVEYOR

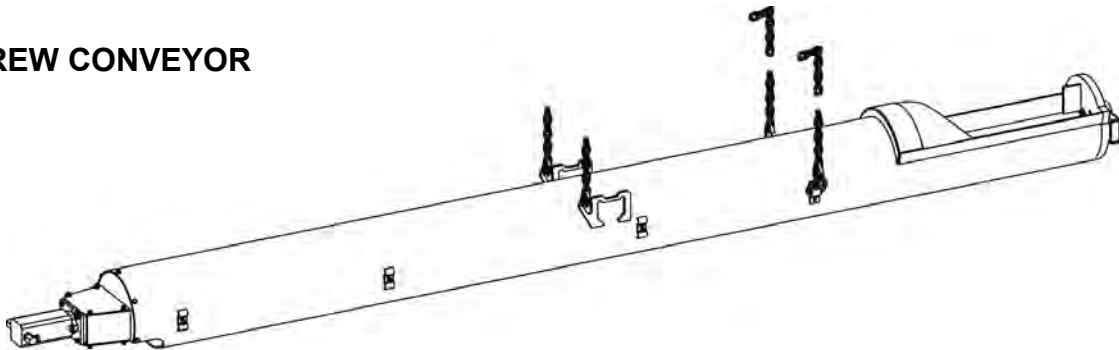

Model	Auger Diameter	Length	Use With TBM
120	12"	15'	360, 48SC, 420, 480, 540
140	14"	15'	540, 600, 660
160	16"	15'	720, 780

Equipped with:
Hydraulic drive motor, four point safety chains, and guards.

YOKES

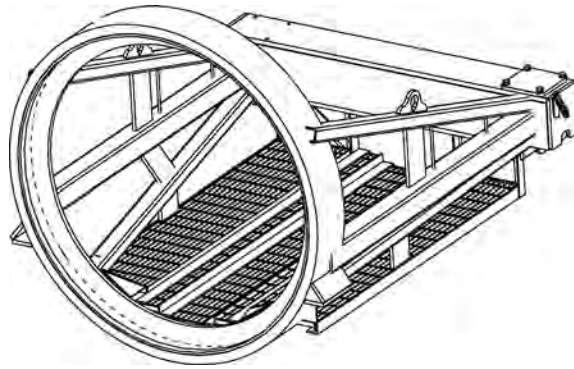

Model	Width	Length	Height
360	72.75" (1,848 mm)	91.5" (2,324 mm)	44" (1,118 mm)
420	72.75" (1,848 mm)	93.5" (2,375 mm)	51" (1,295 mm)
480	72.75" (1,848 mm)	93.5" (2,375 mm)	58" (1,473 mm)
540	72.75" (1,848 mm)	93.5" (2,375 mm)	65" (1,651 mm)
540 Ext	72.75" (1,848 mm)	123.5" (3,137 mm)	65" (1,651 mm)
600	77.5" (1,969 mm)	93.75" (2,381 mm)	72.5" (1,829 mm)
600 Ext	77.5" (1,969 mm)	123.75" (3,137 mm)	72" (1,829 mm)
660	79" (2,007 mm)	93.75" (2,381 mm)	79" (2,007 mm)
720	86" (2,184 mm)	93.75" (2,381 mm)	86" (2,184 mm)
720 Ext	86" (2,184 mm)	123.75" (3,137 mm)	86" (2,184 mm)
780	93" (2,362 mm)	123.75" (3,137 mm)	93" (2,362 mm)

SKIDS

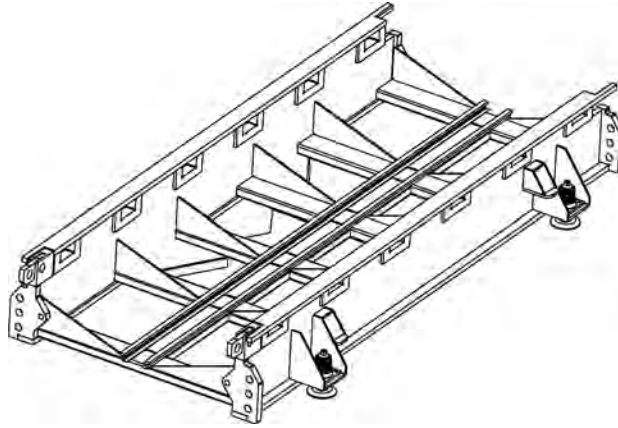

Model	Width	Length	Height	Weight
2.5 ft	80" (2,032 mm)	30" (762 mm)	25.5" (648 mm)	1,500 lbs. (680 kg)
7.5 ft	91" (2,311 mm)	90" (2,286 mm)	25.5" (648 mm)	4,200 lbs. (1,905 kg)
15 ft	91" (2,311 mm)	180" (4,572 mm)	25.5" (648 mm)	8,400 lbs. (3,810 kg)
22.5 ft	91" (2,311 mm)	270" (6,858 mm)	25.5" (648 mm)	12,600 lbs. (5,715 kg)

NOTES

Identification Numbers

Model and serial numbers are required when ordering parts or requesting service information. Record your model and serial numbers below.

TUNNEL BORING MACHINE (A)

Model Number _____

Serial Number _____



BELT CONVEYOR (B)

Model Number _____

Serial Number _____

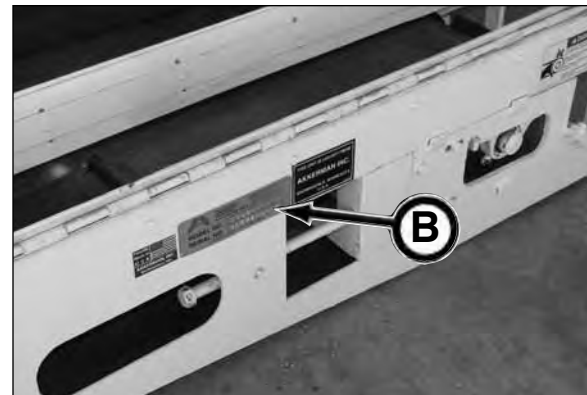

SKID (C)

Model Number _____

Serial Number _____

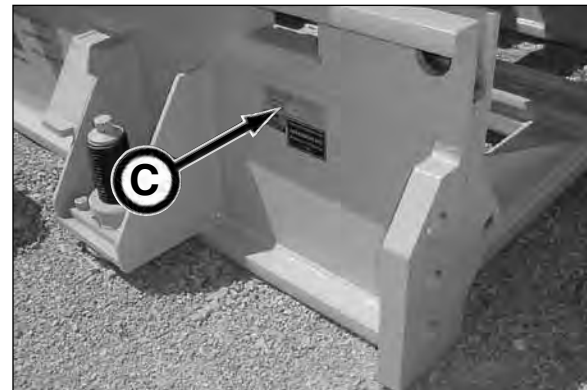

YOKE (D)

Model Number _____

Serial Number _____

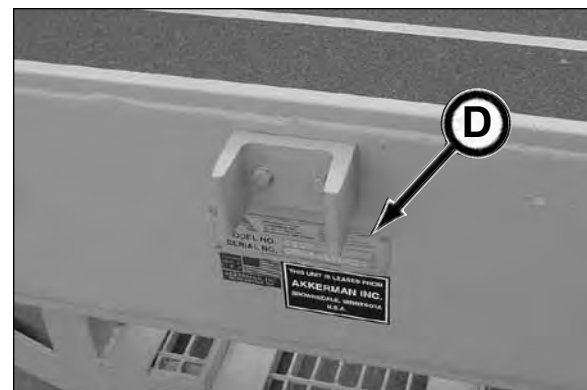

NOTES

Safety Data Sheets

The Federal Occupational, Safety, and Health Administration (OSHA) Standard 29 CFR 1910.1200, require that specific safety data sheets (SDS) be available to employees before operating this equipment. This may include information on substances contained in this equipment such as hydraulic fluid and gear lubricant.

Akkerman Inc. will provide, at no cost, SDS which apply to its product line. Simply contact your Akkerman Aftermarket Support representative for a copy.

To ensure a prompt response to your SDS request, include your return address (including zip or postal code) and the equipment's model numbers and serial numbers with your request.

NOTES

Warranty

Akkerman Inc. warrants that all equipment manufactured by it be free from defects due to workmanship or material under normal use and service for a period of 90 days. This warranty does not apply to normal wear items such as cutter teeth, filters, etc. Akkerman Inc. does not warrant the fitness of its equipment for a particular purpose or application.

Warranty

NOTES

Index

A

Accessing front of TBM	6-36
Adding pipe	6-40
Adjusting overcut	6-38
Adjustments, steering	6-35
Adjustment, TBM roll	6-36
After each drive, maintenance chart TBM	9-8
After each drive, maintenance detail TBM.....	9-33
After first drive or 100 hrs, maintenance chart TBM	9-7
After first drive or 100 hrs, maintenance detail TBM	9-30
Attachments terminology, cutter head	3-5
Auger, inspect	9-57, 9-64
Auger operation	1-6
Auxiliary control or closed face	4-10
Auxiliary control, using closed face or	6-39
Auxiliary motors & boring head	6-41

B

Bearing cavity	4-4, 4-11, 4-12, 6-16
.....	9-14, 9-15, 9-20, 9-30, 9-33
Bearing cavity lubricant	8-1
Bearing cavity maintenance	9-30
Bearing cavity oil filter	9-15, 9-20, 9-34
Bearing cavity oil level	9-14, 9-20, 9-33
Bearing cavity vent	9-14, 9-28, 9-33
Bearing lubrication pump	4-3
Bearing oil cavity shutoff valve	9-20, 9-34
Bearing oil lube filter	4-12
Bearing oil lube filter indicator	4-12, 6-20
Bearing oil manifold	4-4, 4-12
Bearing oil pump	4-12, 6-16
Bearing seal grease	8-1, 9-35
Bearing seal grease pump	6-16
Belt	9-41, 9-49
Belt adjustment screw	9-52
Belt conveyor, maintenance charts -	9-37
Belt conveyor operation	1-6
Belt conveyor safety decals	2-4
Belt scrapers	9-43, 9-48
Belt terminology, conveyor -	3-6
Belt tracking & tension	9-42, 9-52
Block, thrust	6-6
Boring grease pressure	4-11, 9-10
Boring grease pressure gauge	4-4
Boring head and auxiliary motors	6-41
Boring head control	4-7, 6-21, 6-26, 9-9, 9-22
Boring head pressure	4-11, 9-10
Boring head rotation	4-7
Boring head rotation pressure	4-11
Bracing	6-6

C

Cable contact, power	1-9
Cable, power	4-3

C (continued)

Cable, tunnel power	1-4, 6-53
Cable weight	6-47
Calibration	4-2
Camlock® connections	6-53
Carbide quad bar head	6-4
Case drain oil	4-5
Cavitation, pump	4-5
Cavity, bearing	4-4, 4-12
Chain, tethered	4-4
Checkout equipment prior to start-up	6-15
Clean equipment	1-3
Clean, job site	1-8
Closed face	6-4
Closed face controls	9-9, 9-23
Closed face cylinders	9-13
Closed face cylinders, lubricate	9-13
Closed face level bar	6-10
Closed face operating guidelines	6-39
Closed face or auxiliary control	4-10
Closed face or auxiliary control, using	6-39
Clothing, protective	1-1
Combustible and toxic gases	4-2
Combustible gases	6-11, 6-29
Connection, incoming power	4-3
Connections, camlock®	6-53
Connections, electrical	1-3
Contact, power cable	1-9
Contact, tunnel wall	1-7
Contamination	4-11, 4-12
Contents	ii
Control, auxiliary	4-10
Control, boring head	4-7, 6-21
Control, conveyor	6-21
Control, dirt/torque wing	4-9
Control, jacking can cylinder	4-9
Control operation	9-9, 9-23
Controls, conveyor	4-6
Controls & instruments	4-1
Control, spring centered	4-7
Controls, steering	4-8, 6-20
Control subsidence	4-10
Control, using closed face or auxiliary	6-39
Control valves, TBM	3-3
Control valves terminology, TBM	3-3
Conveyor	6-3
Conveyor - belt	3-5
Conveyor, belt, maintenance charts -	9-37
Conveyor belt tension	9-42, 9-52
Conveyor - belt terminology	3-6
Conveyor cables	4-6
Conveyor control	4-6, 6-21, 6-34, 9-9, 9-23
Conveyor drive & speed control	4-6
Conveyor hook	6-13, 6-19
Conveyor lift ..	4-6, 6-12, 6-19, 6-21, 6-33, 9-12, 9-22, 9-29
Conveyor lift, lubricate	9-12

C (continued)

Conveyor, operating the	6-33
Conveyor operation	1-6, 1-7
Conveyor operation, belt	1-6
Conveyor operation guidelines	6-33
Conveyor pressure	9-10
Conveyor safety chains	6-12, 6-13
Conveyor safety decals, belt	2-4
Conveyor safety decals, screw	2-5
Conveyor safety hook	9-45, 9-48
Conveyor safety switch	4-4
Conveyor safety valve	1-6,4-3,4-4,4-5,5-1,6-13, 6-19,6-25,6-33,9-9,9-23,11-1,12-2
Conveyor safety valve trips	4-4, 11-2, 11-4
Conveyor - screw	3-7
Conveyor, screw, maintenance charts	9-54
Conveyor - screw terminology	3-7
Conveyors specifications	12-3
Conveyor troubleshooting	11-4
Crane operation	1-7
Cutter bar	6-22, 9-22
Cutter head attachments terminology	3-5
Cutterhead drive dump valve	6-23
Cutter head rotation	4-7
Cutter heads	6-4
Cutter ring	6-38, 9-36
Cutter teeth	6-9, 9-11
Cylinder control, jacking can	4-9
Cylinder psi, steering	4-11
Cylinders, steering	4-8,6-35

D

Daily or every 10 hours of operation maintenance chart	
Belt conveyor	9-37
Screw conveyor	9-54
TBM	9-5
Daily or every 10 hours of operation maintenance detail	
Belt conveyor	9-46
Screw conveyor	9-61
TBM	9-20
Daily shut down	6-50
Damage, structural	4-11
Decals, belt conveyor safety	2-4
Decals, inspect	9-19, 9-45, 9-49, 9-60, 9-63
Decals, laser sight safety	2-6
Decals, safety	2-1
Decals, screw conveyor safety	2-5
Decals, TBM safety	2-2, 2-3
Design, shaft layout	6-6
Detector, gas	4-2
Detent function, friction	4-6
Dirt bucket	6-27
Dirt guard	9-45, 9-51
Dirt paddles	9-35
Dirt/torque wing control	4-9
Dirt wing	4-9, 6-36, 9-12, 9-27

D (continued)

Dirt wing controls	9-9, 9-23
Dirt wing/torque wing, lubricate	9-13
Drive chain	9-43, 9-51, 9-59, 9-65
Drive chain cover	9-46
Drive end inner bearing	9-59, 9-62
Drive guard	9-59, 9-63
Drive motor bolt tightness	9-51, 9-60, 9-64
Drive roller	9-40, 9-46
Drive sprockets	9-59, 9-65
Dual feed	6-14
Dual & single feed hydraulic setup	6-14

E

Electrical connections	1-3
Electrical schematic, pit power box	11-7
Electrical schematic, TBM	11-6
Emergency stop	4-1
Emergency stop, using	6-16
Encountering an obstruction	6-36
Engineer, structural	6-6
Equipment, clean	1-3
Equipment, inspect	1-3
Equipment, recommended tools &	6-5
E-stop .. 4-1, 6-41, 6-50, 6-51, 9-1, 9-2, 9-9, 9-23	
Exposure, laser light	1-9
External power source	6-18

F

Federal regulations	6-6
Feed hydraulics, dual	6-14
Feed hydraulics, single	6-14
Filter, bearing cavity oil	9-15
Filter, bearing oil lube	4-12
Filter indicator	4-12, 9-16
Filter indicator, bearing oil lube	4-12
Filter indicators, pressure	4-12
Filter, in-line	4-4
Filter, pressure	4-12
Fire prevention	1-5
Floor, shaft	6-6
Fluids under pressure	1-2, 9-3
Frame, jacking	6-6
Friction detent	6-21, 6-34
Friction detent function	4-6
Front roller	9-40, 9-47

G

Gas detection system	6-19
Gas detector	4-2, 4-5, 6-16, 9-9, 9-23, 9-36
Gas detector, using	6-37
Gases, combustible and toxic	4-2, 6-11
Gases, hazardous	6-6
Gases, toxic	6-11
Gas levels	6-11
Gas, methane	4-2
Gas sensor	4-2

G (continued)

Gauge, boring grease pressure	4-4
Gauge operation	9-10
Gauges, pressure	4-11
Gauges, steering psi	4-8
Gauges terminology, TBM pressure	3-3
Generator	6-11
Grade	9-11
Grease	8-2
Grease, bearing seal	8-1
Grease manual power switch, lube &	4-4
Grease pressure, boring	4-11, 9-10
Grease pressure gauge, boring	4-4
Grease pump	4-4
Grease pump manual switch, lube &	4-11
Grease reservoir, seal	4-4, 9-16
Grease, steering joint	8-2
Grease system schematic	11-8
Guidance system, laser	6-10
Guidelines, closed face operating	6-39
Guidelines, conveyor operation	6-33
Guidelines, operating	6-1
Guidelines, transporting	7-1

H

Haul unit	1-7, 6-31, 6-32
Haul unit, lockout power before servicing	1-8
Haul unit system	6-3
Haul unit, using	6-37
Hazardous gases	6-6
Head, carbide quad bar	6-4
Hookup, supply hose	6-14
Hose hookup, supply	6-14
Hourmeters	9-1
Hydraulic hoses	9-22, 9-45, 9-50, 9-60, 9-63
Hydraulic schematic, TBM	11-5
Hydraulic setup, pump unit	6-14
Hydraulic setup, single & dual feed	6-14
Hydraulic setup, TBM	6-14

I

Identification numbers	13-1
Idler rollers	9-44, 9-48
IJS	6-54
IJS, installing	6-46
IJS line holder	6-47
IJS, operating	6-48
IJS schematic	6-49
IJS sequence	6-49
IJS, using	6-46
Incoming power	6-17
Incoming power connection	4-3
Indicator, bearing oil lube filter	4-12
Indicator, filter	4-12
Indicators, pressure filter	4-12
Information, safety	1-1
Inlet pressure	4-11
In-line filter	4-4, 4-11

I (continued)

Inner drum & bearing bolts	9-14
Inner drum level bar	6-10
Inspect equipment	1-3
Inspection, pre-start	5-1
Installing IJS	6-46
Instruments & controls	4-1
Intermediate jacking station sequence	6-49
Intervals, maintenance & lubrication	9-1
Introduction	i

J

Jacking can cylinder control	4-9
Jacking can cylinders	4-9
Jacking frame	6-6, 6-9
Jacking system	6-10
Jacking system layout, pipe	6-4
Jacking system, pipe	6-3
Jacking system, removing TBM and	6-52
Jacking system, setting up	6-7
Job site clean	1-8
Joint grease, steering	8-2

L

Laser	6-6
Laser guidance system	6-10, 6-31
Laser light	6-45
Laser light exposure	1-9
Laser light stand terminology	3-8
Laser sight safety decals	2-6
Launching the TBM	6-23
Launch shaft	6-6
Layout design, shaft	6-6
Layout, pipe jacking system	6-4
Level	6-9, 6-10
Level bar, closed face	6-10
Level bar, inner drum	6-10
Leveling screws	9-26
Level, side to side	6-9
Lift d-rings	9-58, 9-62
Lifting chains	9-44, 9-47, 9-58, 9-61
Lifting eyes	6-26, 6-46, 9-36, 9-43, 9-46, 9-58, 9-62
Light, 24 VDC power on	4-5
Light exposure, laser	1-9
Light stand terminology, laser	3-7
Light, tunnel power phase ok	4-3, 4-5, 6-19, 6-45
Line clamps	9-58, 9-62, 9-64
Line & grade	9-11
Loads, suspended	1-2
Locator pin	6-7
Lockout power before servicing	1-2, 9-2
Lockout power before servicing haul unit	1-8
Lube filter indicator, bearing oil	4-12
Lube & grease manual power switch	4-4
Lube & grease pump manual switch	4-11
Lube system schematic	11-9
Lubricant, bearing cavity	8-1
Lubricants	8-1

L (continued)

Lubricants, storing	8-2
Lubrication & maintenance intervals	9-1
Lubrication system	4-10

M

Magnetic sensor	4-2
Main power switch	4-3, 9-2
Main power switch, pump unit	6-41, 6-51
Main power switch, TBM	6-17, 6-50
Main power switch, TBM	6-41, 6-52
Maintenance, before performing	9-1
Maintenance charts	
Belt conveyor	9-37
Screw conveyor	9-54
TBM	9-4
Maintenance charts, after each drive	
TBM	9-8
Maintenance charts, daily or every 10 hours	
Belt conveyor	9-38
Screw conveyor	9-55
TBM	9-5
Maintenance charts, after first drive or first 100 hours	
TBM	9-7
Maintenance charts, monthly or every 250 hours	
TBM	9-7
Maintenance charts, prior to each job launch	
Belt conveyor	9-37
Screw conveyor	9-54
TBM	9-4
Maintenance charts, weekly or every 50 hours	
Belt conveyor	9-39
Screw conveyor	9-56
TBM	9-6
Maintenance detail, after each drive	
TBM	9-33
Maintenance detail, daily or every 10 hours	
Belt conveyor	9-46
Screw conveyor	9-61
TBM	9-20
Maintenance detail, after first drive or first 100 hours	
TBM	9-30
Maintenance detail, monthly or every 250 hours	
TBM	9-30
Maintenance detail, prior to each job launch	
Belt conveyor	9-40
Screw conveyor	9-57
TBM	9-9
Maintenance detail, weekly or every 50 hours	
Belt conveyor	9-51
Screw conveyor	9-64
TBM	9-286
Maintenance & lubrication intervals	9-1
Maintenance, periodic	9-1
Maintenance, safe	1-4
Manifold, bearing oil	4-4, 4-12

M (continued)

Manual power switch, lube & grease	4-4
Maximum steering cylinder pressure .. 4-11, 6-35, 9-10	
Maximum steering pressure	4-8
Methane gas	4-2
Monthly or every 250 hours, maintenance chart	
TBM	9-7
Monthly or every 250 hours, maintenance detail	
TBM	9-30
Moving parts	1-3

N

Nose bearing, lubricate	9-57, 9-61
Nose bracket, inspect & lubricate	9-44, 9-49
Numbers, serial	13-1

O

Obstruction, encountering an	6-36
Oil, case drain	4-5
Oil level, bearing cavity	9-14
Oil lube filter indicator, bearing	4-12
Ok light, tunnel power phase	4-3, 4-5
On light, 24 VDC power	4-5
Operating guidelines	6-1
Operating guidelines, closed face	6-39
Operating IJS	6-48
Operating the conveyor	6-33
Operation	6-1
Operation, auger	1-6
Operation, belt conveyor	1-6
Operation, conveyor	1-6, 1-7
Operation, crane	1-7
Operation guidelines, conveyor	6-33
Operation, sand shelf	6-38
Overcut, adjusting	6-38
Overview, system	6-3
Oxygen-deficient atmosphere	6-37

P

Parallel drum	6-10
Parts, moving	1-3
Performing maintenance, before	9-1
Periodic maintenance	9-1
Phase ok light, tunnel power	4-3, 4-5, 6-45
Pinch points	1-4, 6-11, 9-3
Pipe, adding	6-40
Pipe jacking system	6-3
Pipe jacking system layout	6-4
Pipeline	6-45
Pit power box electrical schematic	11-7
Planning, site	6-5
Power before servicing haul unit, lockout	1-8
Power before servicing, lockout	1-2, 9-2
Power cable contact	1-9
Power cables	4-3, 9-22
Power cable, tunnel	1-4
Power connection, incoming	4-3

P (continued)

Power on light, 24 VDC	4-5
Power phase ok light, tunnel	4-3, 4-5, 6-45
Power source	6-10
Power source, external	6-18
Power switch, lube & grease manual	4-4
Power switch, main	4-3, 9-2
Power switch, TBM main	6-17, 6-41, 6-50
Preparation, site	6-6
Preparing for storage	10-1
Pressure, boring grease	4-11, 9-10
Pressure, boring head	4-11, 9-10
Pressure, boring head rotation	4-11
Pressure, conveyor	9-10
Pressure filter	4-12
Pressure filter indicators	6-20
Pressure filter indicators	4-12, 9-16, 9-24
Pressure, fluids under	1-2, 9-3
Pressure gauge, boring grease	4-4
Pressure gauges	4-11
Pressure gauges terminology, TBM	3-3
Pressure, inlet	4-11
Pressure, maximum steering cylinder ..	4-11, 6-35
Pressure, maximum system	4-8
Pressure peaks	6-12
Pressures, steering cylinder	4-8, 6-35
Pressure, steering	9-10
Pressure, steering cylinder	4-11, 6-35
Pressure, system	9-10
Pressure, system	4-11, 6-35
Pre-start inspection	5-1
Prevention, fire	1-5
Prior to each job launch, maintenance chart	
Belt conveyor	9-37
Screw conveyor	9-54
TBM	9-4
Prior to each job launch, maintenance detail	
Belt conveyor	9-40
Screw conveyor	9-57
TBM	9-9
Procedure, TBM start-up	6-17
Protective clothing	1-1
Psi gauges, steering	4-8
Psi, steering cylinder	4-11
Pump, bearing lubrication	4-3
Pump, bearing oil	4-12
Pump cavitation	4-5
Pump, grease	4-4
Pump, scavenging	4-3, 4-5
Pump unit	6-18
Pump unit controls	6-44
Pump unit hydraulic setup	6-14
Pump unit main power switch	6-41, 6-51
Push blocks	6-26

Q

Quad bar head, carbide	6-4
------------------------------	-----

R

Rails, inspect	9-26
Ram retaining pin, inspect	9-27
Reception shaft	6-6
Recommended tools & equipment	6-5
Recycle waste	1-9
Regulations	6-6
Relay/transmitter	4-2
Removing from storage	10-1
Removing TBM and jacking system	6-52
Reservoir, scavenging pump	4-5
Reservoir, seal grease	4-4, 9-16
Roll adjustment, TBM	6-36
Roller scrapers	9-41
Rotation, boring head	4-7
Rotation pressure, boring head	4-11

S

Safe maintenance	1-4
Safety	1-1
Safety chains	6-13
Safety chains, conveyor	6-12
Safety data sheets	14-1
Safety decals	2-1
Safety decals, belt conveyor	2-4
Safety decals, laser sight	2-6
Safety decals, screw conveyor	2-5
Safety decals, TBM	2-2, 2-3
Safety information	1-1
Safety switch, conveyor	4-4
Safety valve trips, conveyor	4-4
Sand shelf operation	6-38
Sand shelves	6-4
Scavenging pump	4-3, 4-5, 6-16
Scavenging pump reservoir	4-5
Schematic, grease system	11-8
Schematic, IJS	6-49
Schematic, lube system	11-9
Schematic, pit power box electrical	11-7
Schematic, TBM electrical	11-6
Schematic, TBM hydraulic	11-5
Scrapers, roller	9-41
Screw conveyor, maintenance charts	9-54
Screw conveyor safety decals	2-5
Screw terminology, conveyor -	3-7
Seal grease, bearing	8-1
Seal grease reservoir	4-4, 9-16, 9-21, 9-35
Sensor, gas	4-2
Sensor, magnetic	4-2
Serial numbers	13-1
Servicing haul unit, lockout power before	1-8
Servicing, lockout power before	1-2, 9-2
Setting up jacking system	6-7
Setting up TBM	6-9
Setup, pump unit hydraulic	6-14
Setup, single & dual feed hydraulic	6-14
Setup, TBM hydraulic	6-14
Shaft floor	6-6

S (continued)

Shaft, launch	6-6
Shaft layout design	6-6
Shaft, reception	6-6
Shoring	6-6
Shut down, daily	6-50
Side to side level	6-9
Single & dual feed hydraulic setup	6-14
Single feed	6-14
Site planning	6-5
Site preparation	6-6
Skid assembly	6-7, 6-8, 6-9
Skid base	9-26
Skids	12-5
Skid split bars	6-8
Skids specifications	12-5
Smoking	1-8
Specifications	12-1
Specifications, conveyors	12-3
Specifications, skids	12-5
Specifications, TBM	12-1
Specifications, yokes	12-4
Speed control & conveyor drive	4-6
Spoils guides	9-44, 9-47
Spring centered control	4-7
Stand terminology, laser light	3-8
Start-up, checkout equipment prior to	6-15
Start-up procedure, TBM	6-17
Steering adjustments	6-35
Steering controls .. 4-8, 6-20, 6-34, 9-9, 9-10, 9-23	
Steering cylinder pressure	4-8, 4-11, 6-35
Steering cylinder pressure, maximum	4-11
Steering cylinder pressures	, , 9-10
Steering cylinder psi	4-11
Steering cylinders	4-8, 6-35, 9-13, 9-28, 9-36
Steering cylinders, lubricate	9-13
Steering joint	9-18, 9-21, 9-33
Steering joint grease	8-2
Steering pressure	9-10
Steering pressure, maximum rated	4-8, 6-35
Steering psi gauges	4-8
Stop, emergency	4-1
Stop, using emergency	6-16
Storage	10-1
Storing lubricants	8-2
Structural damage	4-11
Structural engineer	6-6
Subsidence control	4-10
Supply hose hookup	6-14
Suspended loads	1-2, 6-7, 6-40, 6-46, 6-54
Switch, conveyor safety	4-4
Switch, lube & grease manual power	4-4
Switch, lube & grease pump manual	4-11
Switch, main power	4-3, 9-2
Switch, pump unit main power	6-51
Switch, TBM main power	6-17, 6-41, 6-50
Switch, tunnel power	9-2
System, haul unit	6-3
System, laser guidance	6-10

TBMseriesI lom-050076

S (continued)

System layout, pipe jacking	6-4
System, lubrication	4-10
System overview	6-3
System, pipe jacking	6-3
System pressure	4-11, 6-35, 9-10
System pressure	4-8, 6-35
System, setting up jacking	6-7

T

Tail end inner bearing	9-57, 9-61
Target position	6-35
TBM	3-1, 3-2, 6-3
TBM, accessing front of	6-36
TBM and jacking system, removing	6-52
TBM control valves terminology	3-3
TBM electrical schematic	11-6
TBM hydraulic schematic	11-5
TBM hydraulic setup	6-14
TBM hydraulic supply	6-44
TBM, launching the	6-23
TBM main power switch ... 6-17, 6-41, 6-50, 6-52	
TBM, maintenance charts	9-4
TBM pressure gauges terminology	3-4
TBM quick disconnects	6-13
TBM roll adjustment	6-36
TBM safety decals	2-2, 2-3
TBM, setting up	6-9
TBM specifications	12-1
TBM start-up procedure	6-17
TBM structure, welding on	9-3
TBM terminology	3-1, 3-2
Teeth, cutter	6-9
Terminology	3-1
Terminology, conveyor - belt	3-6
Terminology, conveyor - screw	3-7
Terminology, cutter head attachments	3-5
Terminology, laser light stand	3-8
Terminology, TBM	3-1, 3-2
Terminology, TBM control valves	3-3
Terminology, TBM pressure gauges	3-4
Tethered chain	4-4
Thrust block	6-6, 6-8, 6-10
Tools & equipment, recommended	6-5
Torque/dirt wing control	4-9, 6-36
Torque wing	4-9, 9-13, 9-29
Torque wing/dirt wing, lubricate	9-13, 9-29
Toxic gases, combustible and	4-2, 6-11, 6-29
Track	6-30, 6-45
Transformer	4-3
Transmitter/relay	4-2
Transporting	7-1
Transporting guidelines	7-1
Trips, conveyor safety valve	4-4
Troubleshooting	11-1
Troubleshooting, conveyor	11-4
Troubleshooting - TBM series ii	11-1
Tunnel power cable	1-4, 6-53

S (continued)

Tunnel power phase ok light... 4-3, 4-5, 6-19, 6-45
 Tunnel power switch 6-53, 9-2
 Tunnel ventilation 1-5
 Tunnel wall 6-37
 Tunnel wall contact 1-7

U

Unauthorized welding 1-3, 9-3
 Unloading compensator block 6-9
 Using closed face or auxiliary control 6-39
 Using emergency stop 6-16
 Using gas detector 6-37
 Using haul unit 6-37
 Using IJS 6-46
 Using intermediate jacking stations (IJS) 6-46

V

Valves, TBM control 3-3
 Valves terminology, TBM control 3-3
 Ventilation, tunnel 1-5

W

Wall contact, tunnel 1-7
 Warranty 15-1
 Waste, recycle 1-9
 Weekly or every 50 hours, maintenance chart
 Belt conveyor 9-39
 Screw conveyor 9-56
 TBM 9-6
 Weekly or every 50 hours, maintenance detail
 Belt conveyor 9-51
 Screw conveyor 9-64
 TBM 9-28
 Welding 1-3, 9-3
 Welding on TBM structure 9-3
 Welding, unauthorized 1-3, 9-3

Y

Yoke 6-8
 Yoke frame 9-26
 Yokes specifications 12-4
 Yoke wheels 9-27

NOTES